

Ball and Roller Bearings



Technical Data		A- 5
Deep Groove Ball Bearings		B- 5
Miniature and Extra Small Bearings		B- 31
Angular Contact Ball Bearings		B- 43
Self-Aligning Ball Bearings		B- 65
Cylindrical Roller Bearings		B- 77
Tapered Roller Bearings		B-119
Spherical Roller Bearings		B-219
Thrust Bearings		B-255
Locknuts, Lockwashers & Lockplates		C- 1
Catalog List & Appendix Table		D- 1

Warranty

NTN warrants, to the original purchaser only, that the delivered product which is the subject of this sale (a) will conform to drawings and specifications mutually established in writing as applicable to the contract, and (b) be free from defects in material or fabrication. The duration of this warranty is one year from date of delivery. If the buyer discovers within this period a failure of the product to conform to drawings or specifications, or a defect in material or fabrication, it must promptly notify NTN in writing. In no event shall such notification be received by NTN later than 13 months from the date of delivery. Within a reasonable time after such notification, NTN will, at its option, (a) correct any failure of the product to conform to drawings, specifications or any defect in material or workmanship, with either replacement or repair of the product, or (b) refund, in part or in whole, the purchase price. Such replacement and repair, excluding charges for labor, is at NTN's expense. All warranty service will be performed at service centers designated by NTN. These remedies are the purchaser's exclusive remedies for breach of warranty.

NTN does not warrant (a) any product, components or parts not manufactured by NTN, (b) defects caused by failure to provide a suitable installation environment for the product, (c) damage caused by use of the product for purposes other than those for which it was designed, (d) damage caused by disasters such as fire, flood, wind, and lightning, (e) damage caused by unauthorized attachments or modification, (f) damage during shipment, or (g) any other abuse or misuse by the purchaser.

THE FOREGOING WARRANTIES ARE IN LIEU OF ALL OTHER WARRANTIES, EXPRESS OR IMPLIED, INCLUDING BUT NOT LIMITED TO THE IMPLIED WARRANTIES OF MERCHANTABILITY AND FITNESS FOR A PARTICULAR PURPOSE.

In no case shall NTN be liable for any special, incidental, or consequential damages based upon breach of warranty, breach of contract, negligence, strict tort, or any other legal theory, and in no case shall total liability of NTN exceed the purchase price of the part upon which such liability is based. Such damages include, but are not limited to, loss of profits, loss of savings or revenue, loss of use of the product or any associated equipment, cost of capital, cost of any substitute equipment, facilities or services, downtime, the claims of third parties including customers, and injury to property. Some states do not allow limits on warranties, or on remedies for breach in certain transactions. In such states, the limits in this paragraph and in paragraph (2) shall apply to the extent allowable under case law and statutes in such states.

Any action for breach of warranty or any other legal theory must be commenced within 15 months following delivery of the goods.

Unless modified in a writing signed by both parties, this agreement is understood to be the complete and exclusive agreement between the parties, superceding all prior agreements, oral or written, and all other communications between the parties relating to the subject matter of this agreement. No employee of NTN or any other party is authorized to make any warranty in addition to those made in this agreement.

This agreement allocates the risks of product failure between NTN and the purchaser. This allocation is recognized by both parties and is reflected in the price of the goods. The purchaser acknowledges that it has read this agreement, understands it, and is bound by its terms.

© NTN Corporation. 2009

Although care has been taken to assure the accuracy of the data compiled in this catalog, NTN does not assume any liability to any company or person for errors or omissions.

NTN

Ball and Roller Bearings



TECHNICAL DATA CONTENTS

1. Classification and Characteristics of Rolling Bearings	A-5	5. Boundary Dimensions and Bearing Number Codes	A-30
1.1 Rolling bearing construction	A-5	5.1 Boundary dimensions	A-30
1.2 Classification of rolling bearings	A-5	5.2 Bearing numbers	A-31
1.3 Characteristics of rolling bearings	A-8		
2. Bearing Selection	A-12	6. Bearing Tolerances	A-35
2.1 Bearing selection flow chart	A-12	6.1 Dimensional accuracy and running accuracy	A-35
2.2 Type and characteristics	A-14	6.2 Chamfer measurements and tolerance or allowable values of tapered bore	A-46
2.3 Selection of bearing arrangement	A-15	6.3 Bearing tolerance measurement methods	A-48
3. Load Rating and Life	A-17	7. Bearing Fits	A-49
3.1 Bearing life	A-17	7.1 Fitting	A-49
3.2 Basic rating life and basic dynamic load rating	A-17	7.2 The necessity of a proper fit	A-49
3.3 Adjusted rating life	A-18	7.3 Fit selection	A-49
3.4 Machine applications and requisite life	A-19		
3.5 Basic static load rating	A-19	8. Bearing Internal Clearance and Preload	A-58
3.6 Allowable static equivalent load	A-20	8.1 Bearing internal clearance	A-58
4. Bearing Load Calculation	A-21	8.2 Internal clearance selection	A-58
4.1 Loads acting on shafts	A-21	8.3 Preload	A-66
4.2 Bearing load distribution	A-23		
4.3 Mean load	A-24	9. Allowable Speed	A-70
4.4 Equivalent load	A-25		
4.5 Bearing rating life and load calculation examples	A-27		

10. Friction and Temperature RiseA-71	14.3 Shaft and housing accuracyA-87
10.1 FrictionA-71	14.4 Allowable bearing misalignmentA-87
10.2 Temperature rise.....A-71	
11. LubricationA-72	15. Bearing HandlingA-88
11.1 Purpose of lubricationA-72	15.1 Bearing storageA-88
11.2 Lubrication methods and characteristicsA-72	15.2 InstallationA-88
11.3 Grease lubricationA-72	15.3 Internal clearance adjustmentA-90
11.4 Solid grease (For bearings with solid grease)A-76	15.4 Post installation running test.....A-92
11.5 Oil lubricationA-77	15.5 Bearing disassemblyA-92
	15.6 Bearing maintenance and inspection ...A-94
12. External bearing sealing devicesA-80	16. Bearing Damage and Corrective MeasuresA-96
13. Bearing MaterialsA-83	17. Technical dataA-100
13.1 Raceway and rolling element materialsA-83	17.1 Deep groove ball bearing radial internal clearances and axial internal clearancesA-100
13.2 Cage materials.....A-83	17.2 Angular contact ball bearing axial load and axial displacementA-100
14. Shaft and Housing DesignA-85	17.3 Tapered roller bearing axial load and axial displacementA-102
14.1 Fixing of bearingsA-85	17.4 Allowable axial load for ball bearings A-102
14.2 Bearing fitting dimensions.....A-86	17.5 Fitting surface pressureA-103
	17.6 Necessary press fit and pullout force A-104

1. Classification and Characteristics of Rolling Bearings

1.1 Rolling bearing construction

Most rolling bearings consist of rings with raceway (inner ring and outer ring), rolling elements (either balls or rollers) and cage. The cage separates the rolling elements at regular intervals, holds them in place within the inner and outer raceways, and allows them to rotate freely.

Raceway (inner ring and outer ring) or raceway washer 1)

The surface on which rolling elements roll is called the "raceway surface". The load placed on the bearing is supported by this contact surface.

Generally the inner ring fits on the axle or shaft and the outer ring on the housing.

Note 1: The raceway of thrust bearing is called "raceway washer," the inner ring is called the "shaft raceway washer" and the outer ring is called the "housing raceway washer."

Rolling elements

Rolling elements classify in two types: balls and rollers. Rollers come in four types: cylindrical, needle, tapered, and spherical.

Balls geometrically contact with the raceway surfaces of the inner and outer rings at "points", while the contact surface of rollers is a "line" contact.

Theoretically, rolling bearings are so constructed as to allow the rolling elements to rotate orbitally while also rotating on their own axes at the same time.

Cages

Cages function to maintain rolling elements at a uniform pitch so load is never applied directly to the cage and to prevent the rolling elements from falling out when handling the bearing. Types of cages differ according to way they are manufactured, and include pressed, machined and formed cages.

1.2 Classification of rolling bearings

Rolling bearings divide into two main classifications: ball bearings and roller bearings. Ball bearings are classified according to their bearing ring configurations: deep groove type and angular contact type. Roller bearings on the other hand are classified according to the shape of the rollers: cylindrical, needle, tapered and spherical.

Rolling bearings can be further classified according to the direction in which the load is applied; radial bearings carry radial loads and thrust bearings carry axial loads.

Other classification methods include: 1) number of rolling rows (single, double, or 4-row), 2) separable and non-separable, in which either the inner ring or the outer ring can be detached.

There are also bearings designed for special applications, such as: railway car journal roller bearings, ball screw support bearings, turntable bearings, as well as linear motion bearings (linear ball bearings, linear roller bearings and linear flat roller bearings). Types of rolling bearings are given in Fig. 1.2.

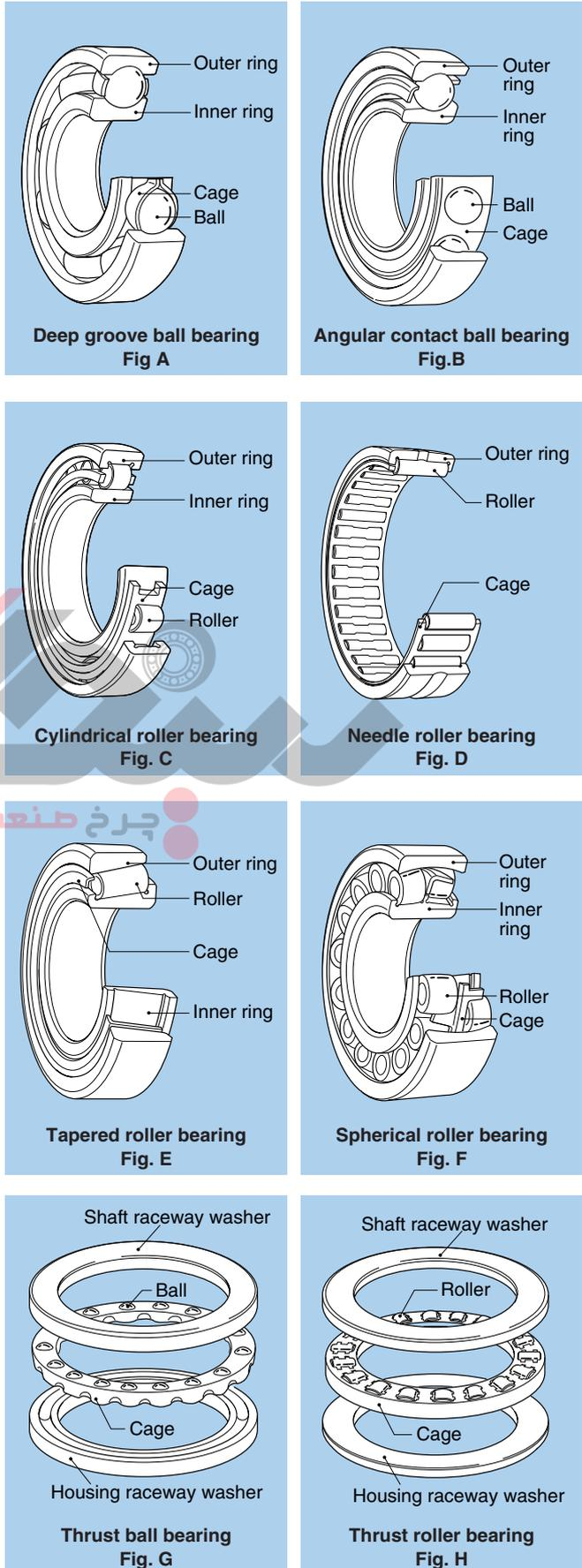

Fig. 1.1 Rolling bearing

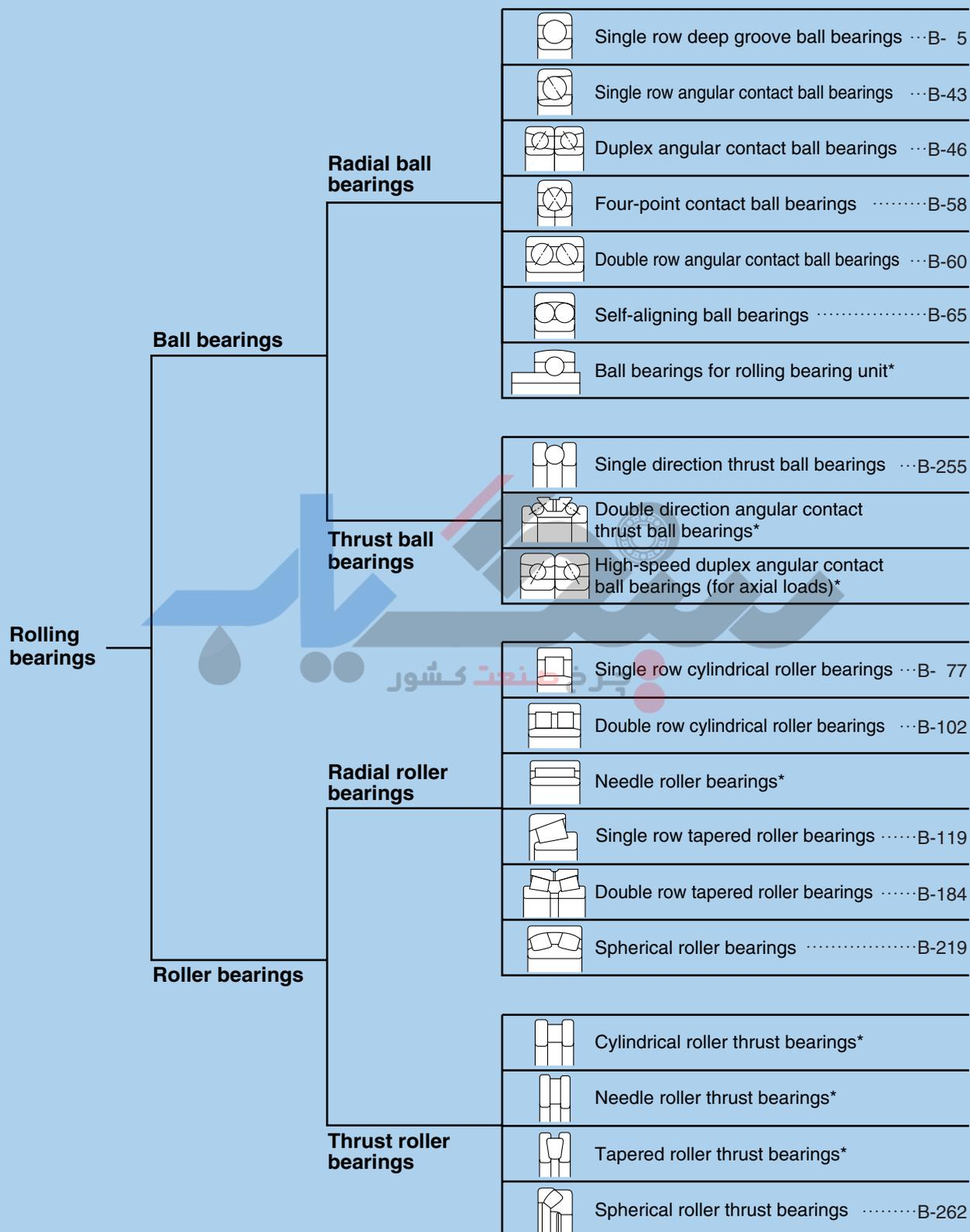
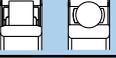
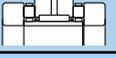
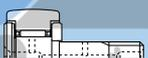

Fig. 1.2 Classification of rolling bearings

Special application bearings

	Ultra thin wall type ball bearings*
	Ball screw support bearings*
	Railway car journal roller bearings*
	Ultra-clean vacuum bearings*
	SL-type cylindrical roller bearings*
	Insulated bearings MEGAOHM™ series*
	Rubber molded bearings*
	Clearance adjusting needle roller bearings*
	Complex bearings*
	Connecting rod needle roller bearings with cage*
	Roller followers*
	Cam followers*

Linear motion bearings

	Linear ball bearings*
	Linear roller bearings*
	Linear flat roller bearings*

Note: Bearings marked with an asterisk are not contained in this catalog.
For details, see the catalog devoted to the concerned type of bearing.

1.3 Characteristics of rolling bearings

1.3.1 Characteristics of rolling bearings

Rolling bearings come in many shapes and varieties, each with its own distinctive features.

However, when compared with sliding bearings, rolling bearings all have the following advantages:

- (1) The starting friction coefficient is lower and there is little difference between this and the dynamic friction coefficient.
- (2) They are internationally standardized, interchangeable and readily obtainable.
- (3) They are easy to lubricate and consume less lubricant.
- (4) As a general rule, one bearing can carry both radial and axial loads at the same time.
- (5) May be used in either high or low temperature applications.
- (6) Bearing rigidity can be improved by preloading.

Construction, classes, and special features of rolling bearings are fully described in the boundary dimensions and bearing numbering system section.

1.3.2 Ball bearings and roller bearings

Table 1.1 gives a comparison of ball bearings and roller bearings.

Table 1.1 Comparison of ball bearings and roller bearings

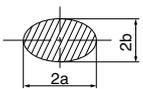
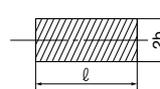
	Ball bearings	Roller bearings
Contact with raceway	 <p>Point contact Contact surface is oval when load is applied.</p>	 <p>Linear contact Contact surface is generally rectangular when load is applied.</p>
Characteristics	Because of point contact there is little rolling resistance, ball bearings are suitable for low torque and high-speed applications. They also have superior acoustic characteristics.	Because of linear contact, rotational torque is higher for roller bearings than for ball bearings, but rigidity is also higher.
Load capacity	Load capacity is lower for ball bearings, but radial bearings are capable of bearing loads in both the radial and axial direction.	Load capacity is higher for roller bearings. Cylindrical roller bearings equipped with a lip can bear slight radial loads. Combining tapered roller bearings in pairs enables the bearings to bear an axial load in both directions.

1.3.3 Radial and thrust bearings

Almost all types of rolling bearings can carry both radial and axial loads at the same time.

Generally, bearings with a contact angle of less than 45° have a much greater radial load capacity and are classed as radial bearings; whereas bearings which have a contact angle over 45° have a greater axial load capacity and are classed as thrust bearings. There are also bearings classed as complex bearings which combine the loading characteristics of both radial and thrust bearings.

1.3.4 Standard bearings and special bearings

The boundary dimensions and shapes of bearings conforming to international standards are interchangeable and can be obtained easily and economically over the world over. It is therefore better to design mechanical equipment to use standard bearings.

However, depending on the type of machine they are to be used in, and the expected application and function, a non-standard or specially designed bearing may be best to use. Bearings that are adapted to specific applications, and "unit bearings" which are integrated (built-in) into a machine's components, and other specially designed bearings are also available.

The feature of typical standard bearings are as follows:

Deep groove ball bearings

The most common type of bearing, deep groove ball bearings are widely used in a variety of fields. Deep groove ball bearings include shield bearings and sealed bearings with grease make them easier to use.

Deep groove ball bearings also include bearings with a locating snap-ring to facilitate positioning when mounting the outer ring, expansion compensating bearings which absorb dimension variation of the bearing fitting surface due to housing temperature, and TAB bearings that are able to withstand contamination in the lubricating oil.

Table 1.2 Configuration of sealed ball bearings

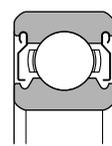
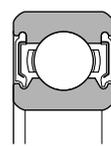
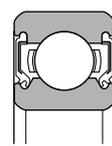
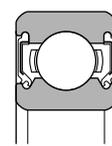
Type and symbol	Shield	Sealed		
	Non-contact ZZ	Non-contact LLB	Contact LLU	Low torque LLH
Configuration				

Angular contact ball bearings

The line that unites point of contact of the inner ring, ball and outer ring runs at a certain angle (contact angle) in the radial direction. Bearings are generally designed with three contact angles.

Angular contact ball bearings can support an axial load, but cannot be used by single bearing because of the contact angle. They must instead be used in pairs or in combinations.

Angular contact ball bearings include double row angular contact ball bearings for which the inner and outer rings are combined as a single unit. The contact angle of double row angular contact ball bearings is 25°.

There are also four-point contact bearings that can support an axial load in both directions by themselves. These bearings however require caution because problems such as excessive temperature rise and wearing could occur depending on the load conditions.

Table 1.3 Contact angle and symbol

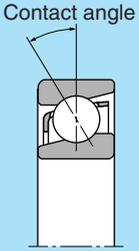

Contact angle and contact angle symbol			
Contact angle	15°	30°	40°
Contact angle symbol	C	A ¹⁾	B

Note 1: Contact angle symbol has been abbreviated as "A".

Table 1.4 Configuration of double row angular contact ball bearings

Type and symbol	Open	Shield ZZ	Non-contact sealed LLM	Contact sealed LLD
Configuration				

Table 1.5 Combinations of duplex angular contact ball bearings

Type and symbol	Back-to-back duplex DB	Face-to-face duplex DF	Tandem duplex DT
Configuration			

Cylindrical roller bearings

Uses rollers for rolling elements, and therefore has a high load capacity. The rollers are guided by the ribs of the inner or outer ring. The inner and outer rings can be separated to facilitate assembly, and both can be fit with shaft or housing tightly. If there is no ribs, either the inner or the outer ring can move freely in the axial direction. Cylindrical roller bearings are therefore ideal to be used as so-called "free side bearings" that absorb shaft expansion. In the case where there is a ribs, the bearing can bear a slight axial load between the end of the rollers and the ribs. Cylindrical roller bearings include the HT type which modifies the shape of roller end face and ribs for increasing axial load capacity. And the E type with a special internal design for enhancing radial load capacity. The E type is standardized for small-diameter sizes.

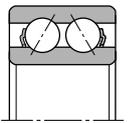
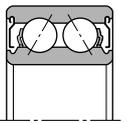
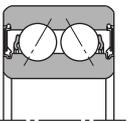
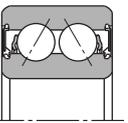
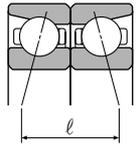
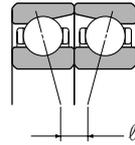
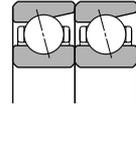
Table 1.6 shows the basic configuration for cylindrical roller bearings.

In addition to these, there are cylindrical roller bearings with multiple rows of rollers and the SL type of full complement roller bearing without cage.

Table 1.6 Types of cylindrical roller bearings

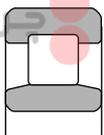
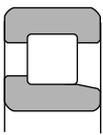
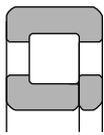
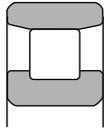
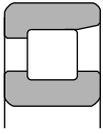
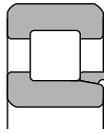
Type and Symbol	NU type N type	NJ type NF type	NUP type NH type (NJ+HJ)
Drawings			
			

Tapered roller bearings

Tapered roller bearings are designed so the inner/outer ring raceway and apex of the tapered rollers intersect at one point on the bearing centerline. By receiving combined load from inner and outer ring, the rollers are pushed against the inner ring rib and roll guided with rib.

Induced force is produced in the axial direction when a radial load is applied, so must be handled by using a pair of bearings. The inner ring with rollers and outer ring come apart, thus facilitating mounting with clearance or preload. Assembled clearance is however hard to manage and requires special attention. Tapered roller bearings are capable of supporting large loads in both the axial and radial directions.

NTN bearings with 4T-, ET-, T- and U attached to the name conform to ISO and JIS standards for sub-unit dimensions (nominal contact angle, nominal small end diameter of outer ring) and are internationally interchangeable.

NTN also has a line of case hardened steel bearings designed for longer life (ETA-, ET-, etc.). NTN tapered roller bearings also include bearings with two and four rows of tapered rollers for extra-heavy loads.

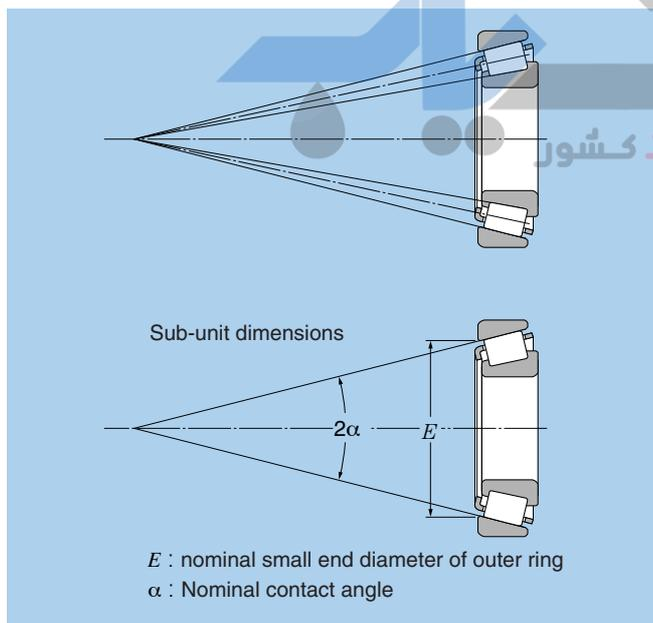

Fig. 1.3 Tapered roller bearings

Spherical roller bearings

Equipped with an outer ring with a spherical raceway surface and an inner ring which holds two rows of barrel-shaped rolling elements, NTN spherical roller bearings are able to adjust center alignment to handle inclination of the axle or shaft.

There are variety of bearing types that differ according to internal design.

Spherical roller bearings include as type equipped with an inner ring with a tapered bore. The bearing can easily be mounted on a shaft by means of an adapter or withdrawal sleeve. The bearing is capable of supporting heavy loads, and is therefore often used in industrial machinery. When heavy axial load is applied to the bearing, the load on rollers of another row is disappeared, and can cause problems. Attention must therefore be paid to operating conditions.

Table 1.7 Types of spherical roller bearings

Type	Standard (B type)	C type	213 type	E type
Configuration				

Thrust bearings

There are many types of thrust bearings that differ according to shape of rolling element and application. Allowable rotational speed is generally low and special attention must be paid to lubrication.

In addition to the ones given below, there are various types of thrust bearings for special applications. For details, see the catalog devoted to the concerned type of bearing.

Table 1.8 Types of thrust bearings

Type	Single direction thrust ball bearing	Needle roller thrust bearing
Configuration		 AXK type AS type raceway washer GS/WS type raceway washer
		 Spherical roller thrust bearing Center alignment angle

Needle roller bearings

Needle roller bearings use needle rollers as rolling elements. The needle rollers are a maximum of 5 mm in diameter and are 3 to 10 times as long as they are in diameter. Because the bearings use needle rollers as rolling elements, the cross-section is thin, but they have a high load capacity for their size. Because of the large number of rolling elements, the bearings have high rigidity and are ideally suited to wobbling or pivoting motion.

There is a profusion of types of needle roller bearings, and just a few of the most representative types are covered here. For details, see the catalog devoted to the concerned type of bearing.

Table 1.9 Main types of needle roller bearings

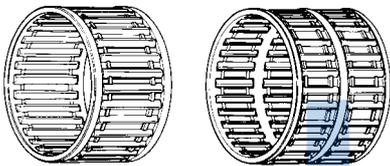
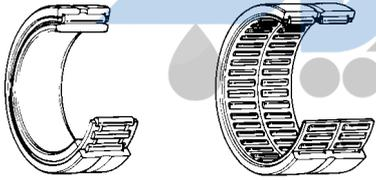
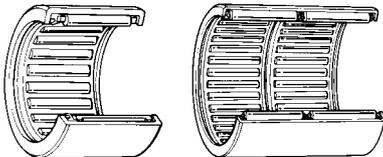
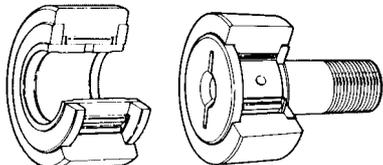
Type	Needle roller bearing with cage
Configuration	
	Solid type needle roller bearings
	
	Shell type needle roller bearings
	
	Roller follower Cam follower
	

Bearing unit

A unit comprised of a ball bearing inserted into various types of housings. The housing can be bolted onto machinery and the inner ring can be easily mounted on the shaft with a set screw.

This means the bearing unit can support rotating equipment without special design to allow for mounting. A variety of standardized housing shapes is available, including pillow and flange types. The outer diameter of the bearing is spherical just like the inner diameter of the housing, so it capable of aligning itself on the shaft.

For lubrication, grease is sealed inside the bearing, and particle generation is prevented by a double seal. For details, see the catalog devoted to the concerned type of bearing.

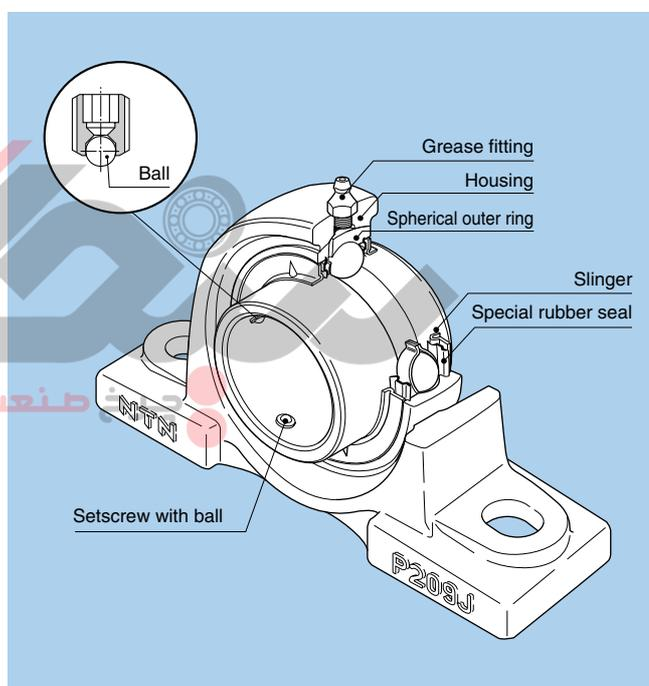

Fig. 1.4 Oil-lubricated bearing unit

2. Bearing Selection

Rolling element bearings are available in a variety of types, configurations, and sizes. When selecting the correct bearing for your application, it is important to consider several factors, and analyse in various means.

A comparison of the performance characteristics for each bearing type is shown in **Table 2.1**. As a general guideline, the basic procedure for selecting the most appropriate bearing is shown in the following flow chart.

2.1 Bearing selection flow chart

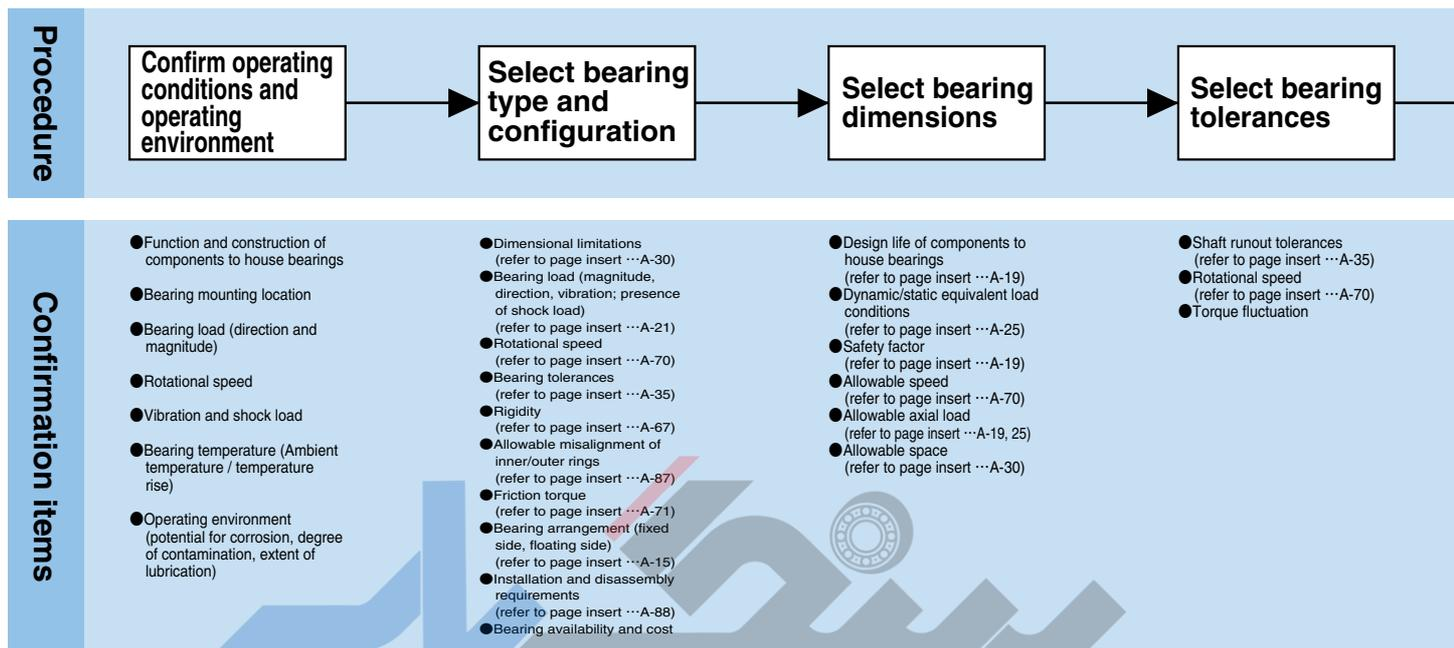

Selection of bearing type and configuration

(1) Dimensional limitations

The allowable space for bearings is generally limited. In most cases, shaft diameter (or the bearing bore diameter) has been determined according to the machine's other design specifications. Therefore, bearing's type and dimensions are determined according to bearing bore diameters. For this reason all dimension tables are organized according to standard bore diameters. There is a wide range of standardized bearing types and dimensions: the right one for a particular application can usually be found in these tables.

(2) Bearing load

The characteristics, magnitude, and direction of loads acting upon a bearing are extremely variable. In general, the basic load ratings shown in bearing dimension tables indicate their load capacity. However, in determining the appropriate bearing type, consideration must also be given to whether the acting load is a radial load only or combined radial and axial load, etc. When ball and roller bearings within the same dimension series are considered, the roller bearings have a larger load capacity and are also capable of withstanding greater vibration and shock loads.

(3) Rotational speed

The allowable speed of a bearing will differ depending upon bearing type, size, tolerances, cage type, load, lubricating conditions, and cooling conditions.

The allowable speeds listed in the bearing tables for grease and oil lubrication are for normal tolerance NTN bearings. In general, deep groove ball bearings, angular contact ball bearings, and cylindrical roller bearings are most suitable for high speed applications.

(4) Bearing tolerances

The dimensional accuracy and operating tolerances of bearings are regulated by ISO and JIS standards. For equipment requiring high tolerance shaft runout or high speed operation, bearings with Class 5 tolerance or higher are recommended. Deep groove ball bearings, angular contact ball bearings, and cylindrical roller bearings are recommended for high rotational tolerances.

(5) Rigidity

Elastic deformation occurs along the contact surfaces of a bearing's rolling elements and raceway surfaces under loading. With certain types of equipment it is necessary to reduce this deformation as much as

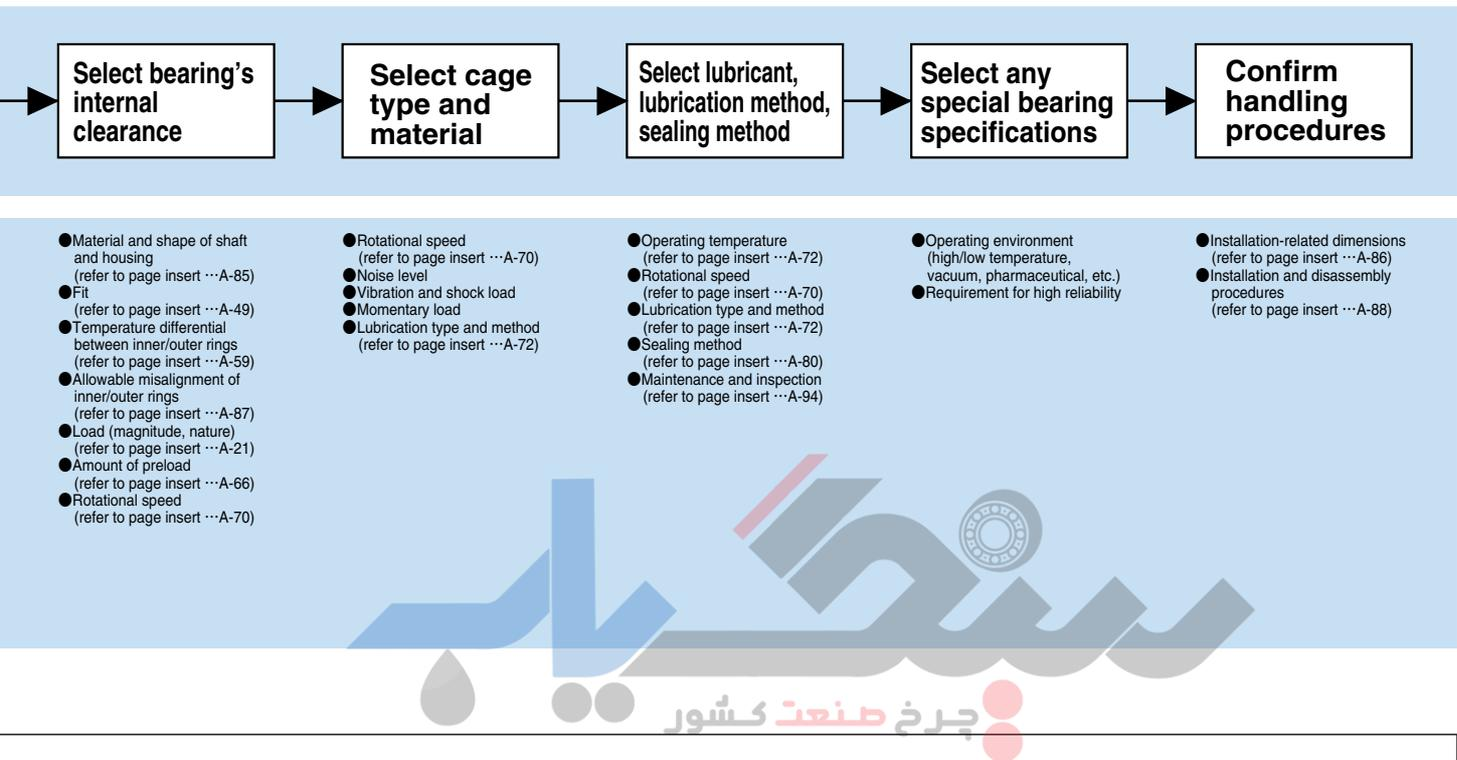

possible. Roller bearings exhibit less elastic deformation than ball bearings. Furthermore, in some cases, bearings are given a load in advance (preloaded) to increase their rigidity. This procedure is commonly applied to deep groove ball bearings, angular contact ball bearings, and tapered roller bearings.

(6) Misalignment of inner and outer rings

Shaft flexure, variations in shaft or housing accuracy, and fitting errors, result in a certain degree of misalignment between the bearing's inner and outer rings. In cases where the degree of misalignment is relatively large, self-aligning ball bearings, spherical roller bearings, or bearing units with self-aligning properties are the most appropriate choices.

(Refer to Fig. 2.1)

(7) Noise and torque levels

Rolling bearings are manufactured and processed according to high precision standards, and therefore generally produce only slight amounts of noise and torque. For applications requiring particularly low-noise or low-torque operation, deep groove ball bearings and cylindrical roller bearings are most appropriate.

(8) Installation and disassembly

Some applications require frequent disassembly and reassembly to enable periodic inspections and repairs. For such applications, bearings with separable inner/outer rings, such as cylindrical roller bearings, needle roller bearings, and tapered roller bearings are most appropriate. Incorporation of adapter sleeves simplifies the installation and disassembly of self-aligning ball bearings and spherical roller bearings with tapered bores.

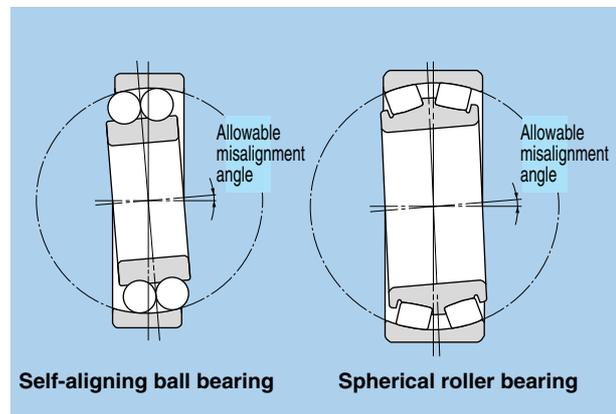

Fig. 2.1

2.2 Type and characteristics

Table 2.1 shows types and characteristics of rolling bearings.

Table 2.1 Type of rolling bearings and performance comparison

Bearing types	Deep groove ball bearings	Angular contact ball bearings	Double row angular contact ball bearings	Duplex angular contact ball bearings	Self-aligning ball bearings	Cylindrical roller bearings	Single-flange cylindrical roller bearings	Double-flange cylindrical roller bearings	Double row cylindrical roller bearings	Needle roller bearings
Characteristics										
Load Carrying Capacity										
Axial load										
High speed ^①	☆☆☆☆	☆☆☆☆	☆☆	☆☆☆☆	☆☆	☆☆☆☆	☆☆☆☆	☆☆☆☆	☆☆☆☆	☆☆☆☆
High rotating accuracy ^①	☆☆☆	☆☆☆	☆☆	☆☆☆☆		☆☆☆	☆☆	☆	☆☆☆	
Low noise/vibration ^①	☆☆☆☆	☆☆☆☆		☆		☆	☆	☆	☆	☆
Low friction torque ^①	☆☆☆☆	☆☆☆☆		☆☆	☆	☆				
High rigidity ^①			☆☆	☆☆		☆☆	☆☆	☆☆	☆☆☆☆	☆☆
Vibration/shock resistance ^①			☆		★	☆☆	☆☆	☆☆	☆☆	☆☆
Allowable misalignment for inner/outer rings ^①	☆				☆☆☆	☆				
Stationary in axial direction ^②	⊙	○	⊙	⊙ For DB and DF arrangement	⊙		○	⊙		
Moveable in axial direction ^③	○		○	○ For DB arrangement	○	○			○	○
Separable inner/outer rings ^④						○	○	○	○	○
Inner ring tapered bore ^⑤					○	○			○	
Remarks		For duplex arrangement				NU, N type	NJ, NF type	NUP, NP, NH type	NNU, NN type	NA type
Reference page	B-5	B-43	B-60	B-43	B-65	B-77	B-77	B-77	B-102	—

Tapered roller bearings	Double-row, 4-row tapered roller bearings	Spherical roller bearings	Thrust ball bearings	Cylindrical roller thrust bearings	Spherical roller thrust bearings	Reference page	Bearing types
							Characteristics
							Load Carrying Capacity
							Radial load
							Axial load
☆☆☆	☆☆	☆☆	☆	☆	☆	A-70	High speed ^①
☆☆☆	☆		☆			A-35	High rotating accuracy ^①
			☆			—	Low noise/vibration ^①
						A-71	Low friction torque ^①
☆☆	☆☆☆☆	☆☆☆☆		☆☆☆	☆☆☆	A-58	High rigidity ^①
☆☆	☆☆☆☆	☆☆☆☆		☆☆☆	☆☆☆	A-21	Vibration/shock resistance ^①
☆		☆☆☆		★	☆☆☆	A-85	Allowable misalignment for inner/outer rings ^①
○	⊙	⊙	○	○	○	A-15	Stationary in axial direction ^②
	○	○	○			A-15	Moveable in axial direction ^③
○	○		○	○	○	—	Separable inner/outer rings ^④
		○				A-85	Inner ring tapered bore ^⑤
For duplex arrangement				Including needle roller thrust bearing		—	Remarks
B-119	B-119	B-219	B-255	—	B-255		Reference page

- ① ☆ The number of stars indicates the degree to which that bearing type displays that particular characteristic. ★ Not applicable to that bearing type.
- ② ⊙ Indicates dual direction. ○ Indicates single direction axial movement only.
- ③ ⊙ indicates movement in the axial direction is possible for the raceway surface; ○ indicates movement in the axial direction is possible for the fitting surface of the outer ring or inner ring.
- ④ ○ Indicates both inner ring and outer ring are detachable.
- ⑤ ○ Indicates inner ring with tapered bore is possible.

2.3 Selection of bearing arrangement

Shafts or axles are generally supported by a pair of bearings in the axial and radial directions. The bearing which prevents axial movement of the shaft relative to the housing is called the **"fixed side bearing"** and the bearing which allows axial movement relatively is called the **"floating-side bearing"**. This allows for expansion and contraction of the shaft due to temperature variation and enables error in bearing mounting clearance to be absorbed.

The **fixed side bearing** is able to support radial and axial loads. A bearing which can fix axial movement in both directions should therefore be selected. A **floating-side bearing** that allows movement in the axial direction while supporting a radial load is desirable. Movement in the axial direction occurs on the raceway surface for bearings with separable inner and outer rings such as

cylindrical roller bearings, and occurs on the fitting surface for those which are not separable, such as deep groove ball bearings.

In applications with short distances between bearings, shaft expansion and contraction due to temperature fluctuations is slight, therefore the same type of bearing may be used for both the fixed-side and floating-side bearing. In such cases it is common to use a set of matching bearings, such as angular contact ball bearings, to guide and support the shaft in one axial direction only.

Table 2.2 (1) shows typical bearing arrangements where the bearing type differs on the fixed side and floating side. **Table 2.2 (2)** shows some common bearing arrangements where no distinction is made between the fixed side and floating side. Vertical shaft bearing arrangements are shown in **Table 2.2 (3)**.

Table 2.2 (1) Bearing arrangement (distinction between fixed and floating-side)

Arrangement		Comment	Application (Reference)
Fixed	Floating		
		<ol style="list-style-type: none"> 1. General arrangement for small machinery. 2. For radial loads, but will also accept axial loads. 	Small pumps, auto-mobile transmissions, etc.
		<ol style="list-style-type: none"> 1. Suitable when mounting error and shaft deflection are minimal or used for high rotational speed application. 2. Even with expansion and contraction of shaft, floating side moves smoothly. 	Medium-sized electric motors, ventilators, etc.
		<ol style="list-style-type: none"> 1. Radial loading and dual direction of axial loading possible. 2. In place of duplex angular contact ball bearings, double-row angular contact ball bearings are also used. 	Worm reduction gear
		<ol style="list-style-type: none"> 1. Heavy loading capable. 2. Shafting rigidity increased by preloading the two back-to-back fixed bearings. 3. Requires high precision shafts and housings, and minimal fitting errors. 	Reduction gears for general industrial machinery
		<ol style="list-style-type: none"> 1. Allows for shaft deflection and fitting errors. 2. By using an adaptor on long shafts without screws or shoulders, bearing mounting and dismounting can be facilitated. 3. Self-aligning ball bearings are used for positioning in the axial direction, and not suitable for applications requiring support of axial load. 	General industrial machinery
		<ol style="list-style-type: none"> 1. Widely used in general industrial machinery with heavy and shock load demands. 2. Allows for shaft deflection and fitting errors. 3. Accepts radial loads as well as dual direction of axial loads. 	Reduction gears for general industrial machinery
		<ol style="list-style-type: none"> 1. Accepts radial loads as well as dual direction axial loads. 2. Suitable when both inner and outer ring require tight fit. 	Reduction gears for general industrial machinery
		<ol style="list-style-type: none"> 1. Capable of handling large radial and axial loads at high rotational speeds. 2. Maintains clearance between the bearing's outer diameter and housing inner diameter to prevent deep groove ball bearings from receiving radial loads. 	Transmissions for diesel locomotives

Table 2.2 (2) Bearing arrangement (no distinction between fixed and floating-side)

Arrangement	Comment	Application (Reference)
	<ol style="list-style-type: none"> 1. General arrangement for use in small machines. 2. Preload is sometimes applied by placing a spring on the outer ring side surface or inserting a shim. (can be floating-side bearings.) 	Small electric motors, small reduction gears, etc.
	<ol style="list-style-type: none"> 1. Back to back arrangement is preferable to face to face arrangement when moment load applied. 2. Able to support axial and radial loads; suitable for high-speed rotation. 3. Rigidity of shaft can be enhanced by providing preload. 	Machine tool spindles, etc.
	<ol style="list-style-type: none"> 1. Capable of supporting extra heavy loads and impact loads. 2. Suitable if inner and outer ring tight fit is required. 3. Care must be taken that axial clearance does not become too small during operation. 	Construction equipment, mining equipment sheaves, agitators, etc.
 <p>Back to back</p> <p>Face to face</p>	<ol style="list-style-type: none"> 1. Withstands heavy and shock loads. Wide range application. 2. Shaft rigidity can be enhanced by providing preload, but make sure preload is not excessive. 3. Back-to-back arrangement for moment loads, and face-to-face arrangement to alleviate fitting errors. 4. With face-to-face arrangement, inner ring tight fit is facilitated. 	Reduction gears, front and rear axle of automobiles, etc.

Table 2.2 (3) Bearing arrangement (Vertical shaft)

Arrangement	Comment	Application (Reference)
	<ol style="list-style-type: none"> 1. When fixing bearing is a duplex angular contact ball bearing, floating bearing should be a cylindrical roller bearing. 	Vertically mounted electric motors, etc.
	<ol style="list-style-type: none"> 1. Most suitable arrangement for very heavy axial loads. 2. Shaft deflection and mounting error can be absorbed by matching the center of the spherical surface with the center of spherical roller thrust bearings. 	Crane center shafts, etc.

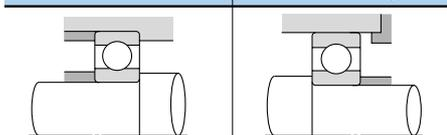
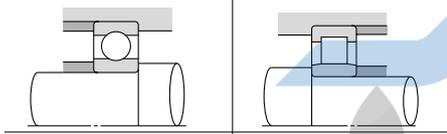
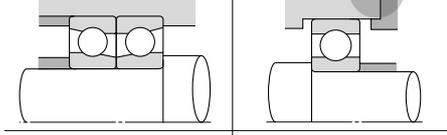
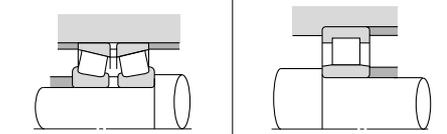
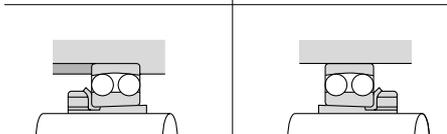
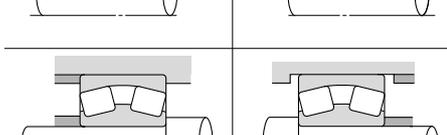
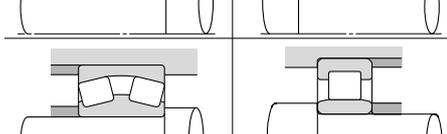
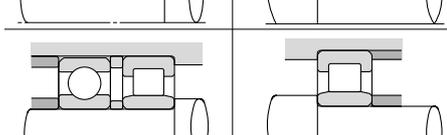
3. Load Rating and Life

3.1 Bearing life

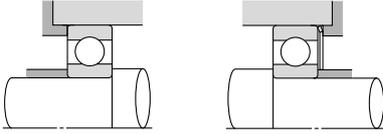
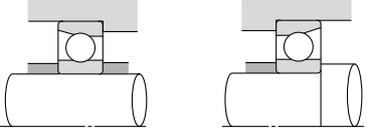
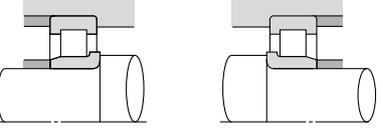
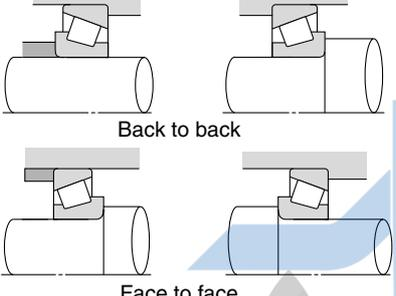
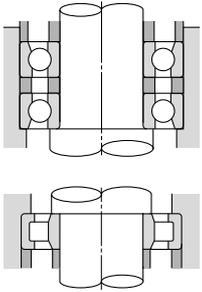
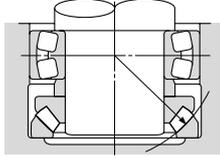
Even in bearings operating under normal conditions, the surfaces of the raceway and rolling elements are constantly being subjected to repeated compressive stresses which causes flaking of these surfaces to occur. This flaking is due to material fatigue and will eventually cause the bearings to fail. The effective life of a bearing is usually defined in terms of the total number of revolutions a bearing can undergo before flaking of either the raceway surface or the rolling element surfaces occurs.

Other causes of bearing failure are often attributed to problems such as seizing, abrasions, cracking, chipping, scuffing, rust, etc. However, these so called "causes" of bearing failure are usually themselves caused by improper installation, insufficient or improper lubrication, faulty sealing or inaccurate bearing selection. Since the above mentioned "causes" of bearing failure can be avoided by taking the proper precautions, and are not simply caused by material fatigue, they are considered separately from the flaking aspect.

3.2 Basic rating life and basic dynamic load rating

A group of seemingly identical bearings when subjected to identical load and operating conditions will exhibit a wide diversity in their durability.

This "life" disparity can be accounted for by the difference in the fatigue of the bearing material itself. This disparity is considered statistically when calculating bearing life, and the basic rating life is defined as follows.

The basic rating life is based on a 90% statistical model which is expressed as the total number of revolutions 90% of the bearings in an identical group of bearings subjected to identical operating conditions will attain or surpass before flaking due to material fatigue occurs. For bearings operating at fixed constant speeds, the basic rating life (90% reliability) is expressed in the total number of hours of operation.

Basic dynamic load rating expresses a rolling bearing's capacity to support a dynamic load. The basic dynamic load rating is the load under which the basic rating life of the bearing is 1 million revolutions. This is expressed as pure radial load for radial bearings and pure axial load for thrust bearings. These are referred to as "basic dynamic load rating (C_r)" and "basic dynamic axial load rating (C_a).". The basic dynamic load ratings given in the bearing tables of this catalog are for bearings constructed of NTN standard bearing materials, using standard manufacturing techniques.

The relationship between the basic rating life, the basic dynamic load rating and the bearing load is given in formula.

For ball bearings: $L_{10} = \left(\frac{C}{P}\right)^3 \dots\dots\dots(3.1)$

For roller bearings: $L_{10} = \left(\frac{C}{P}\right)^{10/3} \dots\dots\dots(3.2)$

where,

- L_{10} : Basic rating life 10^6 revolutions
- C : Basic dynamic load rating, N {kgf}
(C_r : radial bearings, C_a : thrust bearings)
- P : Equivalent dynamic load, N {kgf}
(P_r : radial bearings, P_a : thrust bearings)
- n : Rotational speed, min^{-1}

The relationship between Rotational speed n and speed factor f_n as well as the relation between the basic rating life L_{10h} and the life factor f_n is shown in **Table 3.1** and **Fig. 3.1**.

Table 3.1 Correlation of bearing basic rating life, life factor, and speed factor

Classification	Ball bearing	Roller bearing
Basic rating life L_{10h} h	$\frac{10^6}{60n} \left(\frac{C}{P}\right)^3 = 500 f_n^3$	$\frac{10^6}{60n} \left(\frac{C}{P}\right)^{10/3} = 500 f_n^{10/3}$
Life factor f_n	$f_n \frac{C}{P}$	$f_n \frac{C}{P}$
Speed factor f_n	$\left(\frac{33.3}{n}\right)^{1/3}$	$\left(\frac{33.3}{n}\right)^{3/10}$

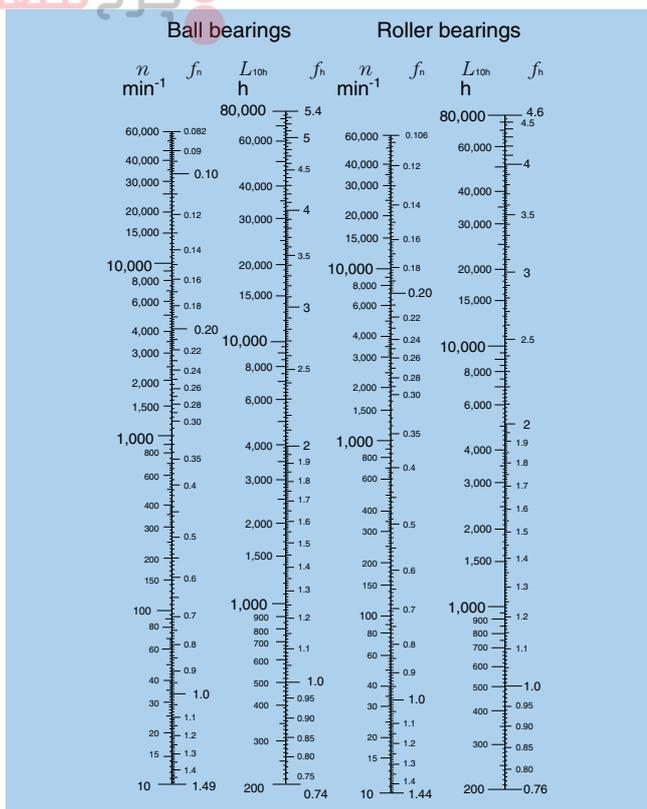

Fig. 3.1 Bearing life rating scale

When several bearings are incorporated in machines or equipment as complete units, all the bearings in the unit are considered as a whole when computing bearing life (see formula 3.3).

$$L = \frac{1}{\left(\frac{1}{L_1^e} + \frac{1}{L_2^e} + \dots + \frac{1}{L_n^e}\right)^{1/e}} \dots\dots\dots (3.3)$$

where,

L : Total basic rating life of entire unit, h

$L_1, L_2 \dots L_n$: Basic rating life of individual bearings, 1, 2, ...n, h

$e = 10/9$For ball bearings

$e = 9/8$For roller bearings

When the load conditions vary at regular intervals, the life can be given by formula (3.4).

$$L_m = \left(\frac{\Phi_1}{L_1} + \frac{\Phi_2}{L_2} + \dots + \frac{\Phi_j}{L_j}\right)^{-1} \dots\dots\dots (3.4)$$

where,

L_m : Total life of bearing

Φ_j : Frequency of individual load conditions ($\sum \Phi_j = 1$)

L_j : Life under individual conditions

If equivalent load P and rotational speed n are operating conditions of the bearing, basic rated dynamic load C that satisfies required life of the bearing is determined using **Table 3.1** and formula (3.5). Bearings that satisfy the required C can be selected from the bearing dimensions table provided in the catalog.

$$C = P \frac{f_h}{f_n} \dots\dots\dots (3.5)$$

3.3 Adjusted rating life

The basic bearing rating life (90% reliability factor) can be calculated through the formulas mentioned earlier in Section 3.2. However, in some applications a bearing life factor of over 90% reliability may be required. To meet these requirements, bearing life can be lengthened by the use of specially improved bearing materials or manufacturing process. Bearing life is also sometimes affected by operating conditions such as lubrication, temperature and rotational speed.

Basic rating life adjusted to compensate for this is called "adjusted rating life," and is determined using formula (3.6).

$$L_{na} = a_1 \cdot a_2 \cdot a_3 L_{10} \dots\dots (3.6)$$

where,

L_{na} : Adjusted rating life in millions of revolutions (10^6)

a_1 : Reliability factor

a_2 : Bearing characteristics factor

a_3 : Operating conditions factor

3.3.1 Reliability factor a_1

The value of reliability factor a_1 is provided in **Table 3.2** for reliability of 90% or greater.

3.3.2 Bearing characteristics factor a_2

Bearing characteristics concerning life vary according to bearing material, quality of material and if using special manufacturing process. In this case, life is adjusted using bearing characteristics factor a_2 .

The basic dynamic load ratings listed in the catalog are based on NTN's standard material and process, therefore, the adjustment factor $a_2 = 1$. $a_2 > 1$ may be used for specially enhanced materials and manufacturing methods. If this applies, consult with NTN Engineering.

Dimensions change significantly if bearings made of high carbon chrome bearing steel with conventional heat treatment are used at temperatures in excess of 120°C for an extended period of time. NTN Engineering therefore offers a bearing for high-temperature applications specially treated to stabilize dimensions at the maximum operating temperature (TS treatment). The treatment however makes the bearing softer and affects life of the bearing. Life is adjusted by multiplying by the values given in **Table 3.3**.

Table 3.2 Reliability factor a_1

Reliability %	L_n	Reliability factor a_1
90	L_{10}	1.00
95	L_5	0.62
96	L_4	0.53
97	L_3	0.44
98	L_2	0.33
99	L_1	0.21

Table 3.3 Treatment for stabilizing dimensions

Symbol	Max. operating temperature (C°)	Bearing characteristics factor a_2
TS2	160	1.00
TS3	200	0.73
TS4	250	0.48

3.3.3 Operating conditions factor a_3

Operating conditions factor a_3 is used to compensate for when lubrication condition worsens due to rise in temperature or rotational speed, lubricant deteriorates, or becomes contaminated with foreign matter.

Generally speaking, when lubricating conditions are satisfactory, the a_3 factor has a value of one; and when lubricating conditions are exceptionally favorable, and all other operating conditions are normal, a_3 can have a value greater than one. a_3 is however less than 1 in the following cases:

- Dynamic viscosity of lubricating oil is too low for bearing operating temperature
(13 mm²/s or less for ball bearings, 20 mm²/s for roller bearings)
- Rotational speed is particularly low
(If sum of rotational speed $n \text{ min}^{-1}$ and rolling element pitch diameter $D_{pw} \text{ mm}$ is $D_{pw} \cdot n < 10,000$)
- Bearing operating temperature is too high
If bearing operating temperature is too high, the raceway becomes softened, thereby shortening life. Life is adjusted by multiplying by the values given in **Fig. 3.2** as the operating condition factor according to operating temperature. This however does not apply to bearings that have been treated to stabilize dimensions.
- Lubricant contaminated with foreign matter or moisture
If using special operating condition, consult with NTN Engineering. Even if $a_2 > 1$ is used for specially bearings made of enhanced materials or produced by special manufacturing methods, $a_2 \times a_3 < 1$ is used if lubricating conditions are not favorable.

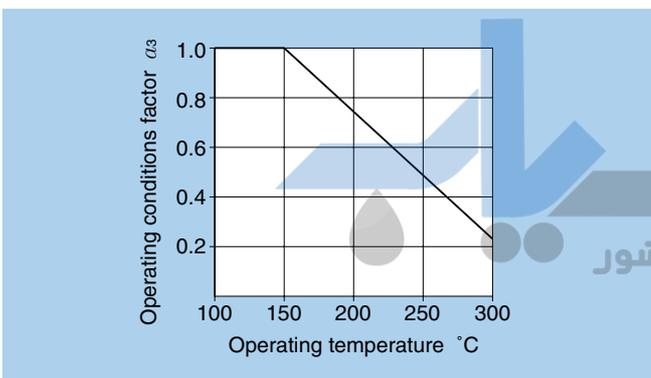

Fig. 3.2 Operating conditions factor according to operating temperature

When a super heavy load is applied, harmful plastic distortion could be produced on the contact surfaces of the rolling elements and raceway. The formulae for determining basic rating life (3.1, 3.2, and 3.6) do not apply if P_r exceeds either C_{or} (Basic static load rating) or $0.5 C_r$ for radial bearings, or if P_a exceeds $0.5 C_a$ for thrust bearings.

3.4 Machine applications and requisite life

When selecting a bearing, it is essential that the requisite life of the bearing be established in relation to the operating conditions. The requisite life of the bearing is usually determined by the type of machine in which the bearing will be used, and duration of service and operational reliability requirements. A general guide to these requisite life criteria is shown in **Table 3.4**. When determining bearing size, the fatigue life of the bearing is an important factor; however, besides bearing life, the strength and rigidity of the shaft and housing must also be taken into consideration.

3.5 Basic static load rating

When stationary rolling bearings are subjected to static loads, they suffer from partial permanent deformation of the contact surfaces at the contact point between the rolling elements and the raceway. The amount of deformity increases as the load increases, and if this increase in load exceeds certain limits, the subsequent smooth operation of the bearings is impaired.

It has been found through experience that a permanent deformity of 0.0001 times the diameter of the rolling element, occurring at the most heavily stressed contact point between the raceway and the rolling elements, can be tolerated without any impairment in running efficiency.

Table 3.4 Machine application and requisite life (reference)

Service classification	Machine application and requisite life (reference) $L_{10h} \times 10^3 \text{ h}$				
	~4	4~12	12~30	30~60	60~
Machines used for short periods or used only occasionally	<ul style="list-style-type: none"> ● Household appliances ● Electric hand tools 	<ul style="list-style-type: none"> ● Farm machinery ● Office equipment 			
Short period or intermittent use, but with high reliability requirements	<ul style="list-style-type: none"> ● Medical appliances ● Measuring instruments 	<ul style="list-style-type: none"> ● Home air-conditioning motor ● Construction equipment ● Elevators ● Cranes 	<ul style="list-style-type: none"> ● Crane (sheaves) 		
Machines not in constant use, but used for long periods	<ul style="list-style-type: none"> ● Automobiles ● Two-wheeled vehicles 	<ul style="list-style-type: none"> ● Small motors ● Buses/trucks ● General gear drives ● Woodworking machines 	<ul style="list-style-type: none"> ● Machine spindles ● Industrial motors ● Crushers ● Vibrating screens 	<ul style="list-style-type: none"> ● Main gear drives ● Rubber/plastic ● Calender rolls ● Printing machines 	
Machines in constant use over 8 hours a day		<ul style="list-style-type: none"> ● Rolling mills ● Escalators ● Conveyors ● Centrifuges 	<ul style="list-style-type: none"> ● Railway vehicle axles ● Air conditioners ● Large motors ● Compressor pumps 	<ul style="list-style-type: none"> ● Locomotive axles ● Traction motors ● Mine hoists ● Pressed flywheels 	<ul style="list-style-type: none"> ● Papermaking machines ● Propulsion equipment for marine vessels
24 hour continuous operation, non-interruptable					<ul style="list-style-type: none"> ● Water supply equipment ● Mine drain pumps/ventilators ● Power generating equipment

The basic static load rating refers to a fixed static load limit at which a specified amount of permanent deformation occurs. It applies to pure radial loads for radial bearings and to pure axial loads for thrust bearings. The maximum applied load values for contact stress occurring at the rolling element and raceway contact points are given below.

For ball bearings	4,200 MPa {428kgf/mm ² }
For self-aligning ball bearings	4,600 MPa {469kgf/mm ² }
For roller bearings	4,000 MPa {408kgf/mm ² }

Referred to as "basic static radial load rating" for radial bearings and "basic static axial load rating" for thrust bearings, basic static load rating is expressed as C_{or} or C_{oa} respectively and is provided in the bearing dimensions table.

3.6 Allowable static equivalent load

Generally the static equivalent load which can be permitted (See page A-25) is limited by the basic static rating load as stated in **Section 3.5**. However, depending on requirements regarding friction and smooth operation, these limits may be greater or lesser than the basic static rating load.

This is generally determined by taking the safety factor S_o given in **Table 3.5** and formula (3.7) into account.

$$S_o = C_o / P_o \dots (3.7)$$

where,

- S_o : Safety factor
- C_o : Basic static load rating, N {kgf}
(radial bearings: C_{or} , thrust bearings: C_{oa})
- P_o : Static equivalent load, N {kgf}
(radial: P_{or} , thrust: C_{oa})

Table 3.5 Minimum safety factor values S_o

Operating conditions	Ball bearings	Roller bearings
High rotational accuracy demand	2	3
Normal rotating accuracy demand (Universal application)	1	1.5
Slight rotational accuracy deterioration permitted (Low speed, heavy loading, etc.)	0.5	1

Note 1: For spherical thrust roller bearings, min. S_o value=4.

Note 2: For shell needle roller bearings, min. S_o value=3.

Note 3: When vibration and/or shock loads are present, a load factor based on the shock load needs to be included in the P_o max value.

Note 4: If a large axial load is applied to deep groove ball bearings or angular ball bearings, the contact oval may exceed the raceway surface. For more information, please contact NTN Engineering.

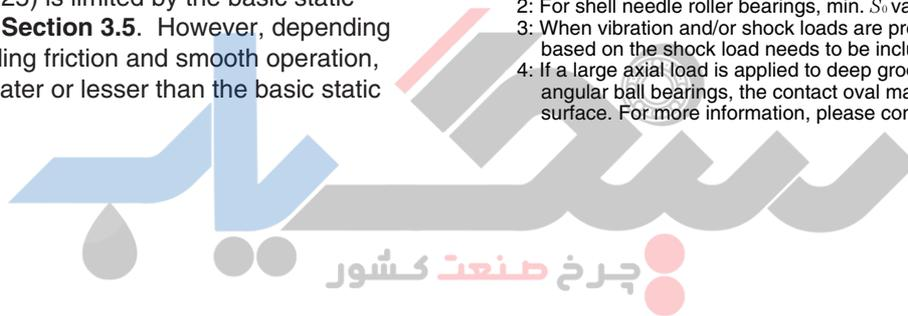

4. Bearing Load Calculation

To compute bearing loads, the forces which act on the shaft being supported by the bearing must be determined. Loads which act on the shaft and its related parts include dead load of the rotator, load produced when the machine performs work, and load produced by transmission of dynamic force. These can theoretically be mathematically calculated, but calculation is difficult in many cases.

A method of calculating loads that act upon shafts that convey dynamic force, which is the primary application of bearings, is provided herein.

4.1 Load acting on shafts

4.1.1 Load factor

There are many instances where the actual operational shaft load is much greater than the theoretically calculated load, due to machine vibration and/or shock. This actual shaft load can be found by using formula (4.1).

$$K = f_w \cdot K_c \dots\dots\dots (4.1)$$

where,

K : Actual shaft load N {kgf}

f_w : Load factor (Table 4.1)

K_c : Theoretically calculated value N {kgf}

Table 4.1 Load factor f_w

Amount of shock	f_w	Application
Very little or no shock	1.0~1.2	Electric machines, machine tools, measuring instruments.
Light shock	1.2~1.5	Railway vehicles, automobiles, rolling mills, metal working machines, paper making machines, printing machines, aircraft, textile machines, electrical units, office machines.
Heavy shock	1.5~3.0	Crushers, agricultural equipment, construction equipment, cranes.

4.1.2 Gear load

The loads operating on gears can be divided into three main types according to the direction in which the load is applied; i.e. tangential (K_t), radial (K_s), and axial (K_a). The magnitude and direction of these loads differ according to the types of gears involved. The load calculation methods given herein are for two general-use gear and shaft arrangements: parallel shaft gears, and cross shaft gears.

(1) Loads acting on parallel shaft gears

The forces acting on spur gears and helical gears are depicted in Figs. 4.1, 4.2, and 4.3. The load magnitude can be found by using or formulas (4.2), through (4.5).

$$\left. \begin{aligned} K_t &= \frac{19.1 \times 10^6 \cdot H}{D_p \cdot n} \quad \text{N} \\ &= \frac{1.95 \times 10^6 \cdot H}{D_p \cdot n} \quad \text{kgf} \end{aligned} \right\} \dots\dots (4.2)$$

$$K_s = K_t \cdot \tan \alpha \quad (\text{Spur gear}) \quad \dots\dots (4.3a)$$

$$= K_t \cdot \frac{\tan \alpha}{\cos \beta} \quad (\text{Helical gear}) \quad \dots\dots (4.3b)$$

$$K_r = \sqrt{K_t^2 + K_s^2} \quad \dots\dots\dots (4.4)$$

$$K_a = K_t \cdot \tan \beta \quad (\text{Helical gear}) \quad \dots\dots (4.5)$$

where,

K_t : Tangential gear load (tangential force), N {kgf}

K_s : Radial gear load (separating force), N {kgf}

K_r : Right angle shaft load (resultant force of tangential force and separating force), N {kgf}

K_a : Parallel load on shaft, N {kgf}

H : Transmission force, kW

n : Rotational speed, min^{-1}

D_p : Gear pitch circle diameter, mm

α : Gear pressure angle, deg

β : Gear helix angle, deg

Because the actual gear load also contains vibrations and shock loads as well, the theoretical load obtained by the above formula should also be adjusted by the gear factor f_z as shown in Table 4.2.

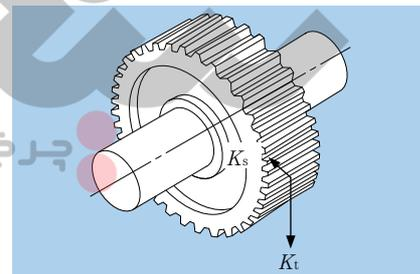

Fig. 4.1 Spur gear loads

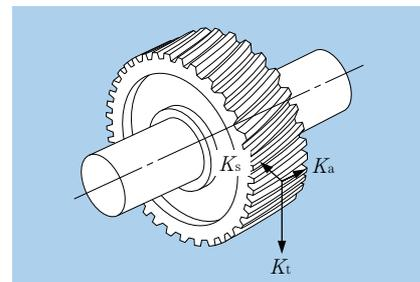

Fig. 4.2 Helical gear loads

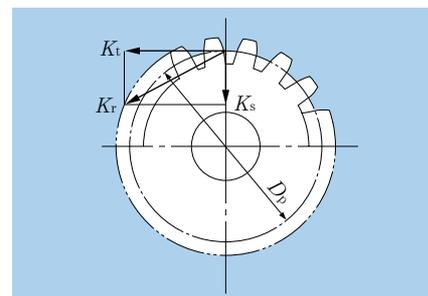

Fig. 4.3 Radial resultant forces

Table 4.2 Gear factor f_z

Gear type	f_z
Precision ground gears (Pitch and tooth profile errors of less than 0.02 mm)	1.05~1.1
Ordinary machined gears (Pitch and tooth profile errors of less than 0.1 mm)	1.1~1.3

(2) Loads acting on cross shafts

Gear loads acting on straight tooth bevel gears and spiral bevel gears on cross shafts are shown in **Figs. 4.4** and **4.5**. The calculation methods for these gear loads are shown in **Table 4.3**. Herein, to calculate gear loads for straight bevel gears, the helix angle $\beta = 0$.

The symbols and units used in **Table 4.3** are as follows:

- K_t : Tangential gear load (tangential force), N {kgf}
- K_s : Radial gear load (separating force), N {kgf}
- K_a : Parallel shaft load (axial load), N {kgf}
- H : Transmission force, kW
- n : Rotational speed, min^{-1}
- D_{pm} : Mean pitch circle diameter, mm
- α : Gear pressure angle, deg
- β : Helix angle, deg
- δ : Pitch cone angle, deg

Because the two shafts intersect, the relationship of pinion and gear load is as follows:

$$K_{sp} = K_{ag} \dots \dots \dots (4.6)$$

$$K_{ap} = K_{sg} \dots \dots \dots (4.7)$$

where,

- K_{sp}, K_{sg} : Pinion and gear separating force, N {kgf}
- K_{ap}, K_{ag} : Pinion and gear axial load, N {kgf}

For spiral bevel gears, the direction of the load varies depending on the direction of the helix angle, the direction of rotation, and which side is the driving side or the driven side. The directions for the separating force (K_s) and axial load (K_a) shown in **Fig. 4.5** are positive directions. The direction of rotation and the helix angle direction are defined as viewed from the large end of the gear. The gear rotation direction in **Fig. 4.5** is assumed to be clockwise (right).

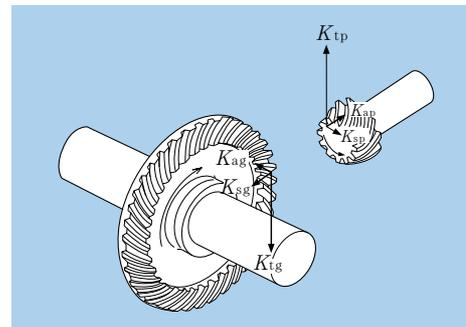

Fig. 4.4 Loads on bevel gears

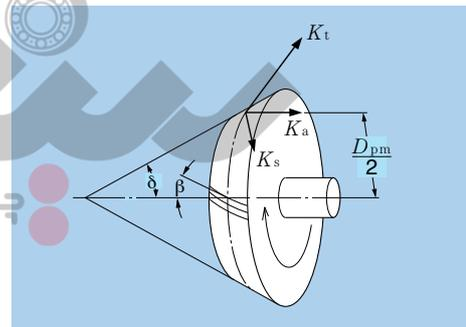

Fig. 4.5 Bevel gear diagram

Table 4.3 Loads acting on bevel gears

Types of load	Rotation direction	Clockwise	Counter clockwise	Clockwise	Counter clockwise
	Helix direction	Right	Left	Left	Right
Tangential load (tangential force) K_t	$K_t = \frac{19.1 \times 10^6 \cdot H}{D_{pm} \cdot n}, \left\{ \frac{1.95 \times 10^6 \cdot H}{D_{pm} \cdot n} \right\}$				
Radial load (separation force) K_s	Driving side	$K_s = K_t \left[\tan \alpha \frac{\cos \delta}{\cos \beta} + \tan \beta \sin \delta \right]$		$K_s = K_t \left[\tan \alpha \frac{\cos \delta}{\cos \beta} - \tan \beta \sin \delta \right]$	
	Driven side	$K_s = K_t \left[\tan \alpha \frac{\cos \delta}{\cos \beta} - \tan \beta \sin \delta \right]$		$K_s = K_t \left[\tan \alpha \frac{\cos \delta}{\cos \beta} + \tan \beta \sin \delta \right]$	
Parallel load on gear shaft (axial load) K_a	Driving side	$K_a = K_t \left[\tan \alpha \frac{\sin \delta}{\cos \beta} - \tan \beta \cos \delta \right]$		$K_a = K_t \left[\tan \alpha \frac{\sin \delta}{\cos \beta} + \tan \beta \cos \delta \right]$	
	Driven side	$K_a = K_t \left[\tan \alpha \frac{\sin \delta}{\cos \beta} + \tan \beta \cos \delta \right]$		$K_a = K_t \left[\tan \alpha \frac{\sin \delta}{\cos \beta} - \tan \beta \cos \delta \right]$	

4.1.3 Chain / belt shaft load

The tangential loads on sprockets or pulleys when power (load) is transmitted by means of chains or belts can be calculated by formula (4.8).

$$K_t = \frac{19.1 \times 10^6 \cdot H}{D_p \cdot n} \quad \text{N} \quad \dots\dots\dots (4.8)$$

$$= \frac{1.95 \times 10^6 \cdot H}{D_p \cdot n} \quad \text{kgf}$$

where,

- K_t : Sprocket/pulley tangential load, N {kgf}
- H : Transmitted force, kW
- D_p : Sprocket/pulley pitch diameter, mm

For belt drives, an initial tension is applied to give sufficient constant operating tension on the belt and pulley. Taking this tension into account, the radial loads acting on the pulley are expressed by formula (4.9). For chain drives, the same formula can also be used if vibrations and shock loads are taken into consideration.

$$K_r = f_b \cdot K_t \dots (4.9)$$

where,

- K_r : Sprocket or pulley radial load, N {kgf}
- f_b : Chain or belt factor (Table 4.4)

Table 4.4 chain or belt factor f_b

Chain or belt type	f_b
Chain (single)	1.2~1.5
V-belt	1.5~2.0
Timing belt	1.1~1.3
Flat belt (w / tension pulley)	2.5~3.0
Flat belt	3.0~4.0

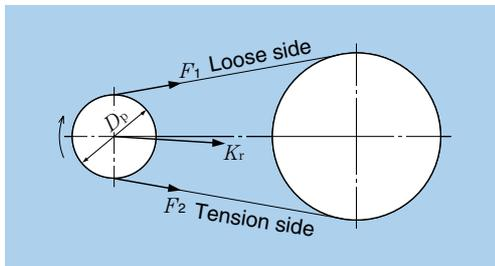

Fig. 4.6 Chain / belt loads

4.2 Bearing load distribution

For shafting, the static tension is considered to be supported by the bearings, and any loads acting on the shafts are distributed to the bearings.

For example, in the gear shaft assembly depicted in Fig. 4.7, the applied bearing loads can be found by using formulas (4.10) and (4.11).

This example is a simple case, but in reality, many of the calculations are quite complicated.

$$F_{rA} = \frac{a+b}{b} F_I + \frac{d}{c+d} F_{II} \dots\dots\dots (4.10)$$

$$F_{rB} = -\frac{a}{b} F_I + \frac{c}{c+d} F_{II} \dots\dots\dots (4.11)$$

where,

- F_{rA} : Radial load on bearing A, N {kgf}
- F_{rB} : Radial load on bearing B, N {kgf}
- F_I, F_{II} : Radial load on shaft, N {kgf}

If directions of radial load differ, the vector sum of each respective load must be determined.

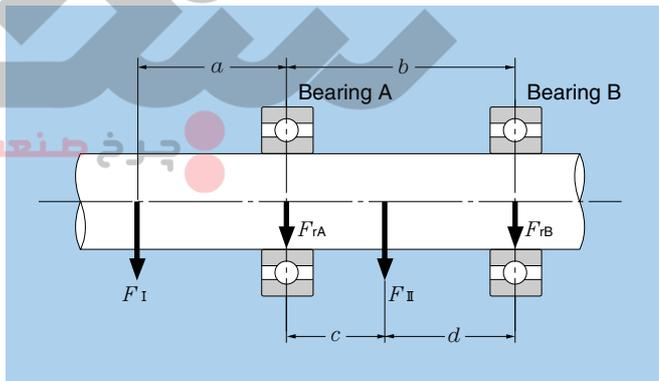

Fig. 4.7

4.3 Mean load

The load on bearings used in machines under normal circumstances will, in many cases, fluctuate according to a fixed time period or planned operation schedule. The load on bearings operating under such conditions can be converted to a mean load (F_m), this is a load which gives bearings the same life they would have under constant operating conditions.

(1) Fluctuating stepped load

The mean bearing load, F_m , for stepped loads is calculated from formula (4.12). F_1, F_2, \dots, F_n are the loads acting on the bearing; n_1, n_2, \dots, n_n and t_1, t_2, \dots, t_n are the bearing speeds and operating times respectively.

$$F_m = \left[\frac{\sum (F_i^p n_i t_i)}{\sum (n_i t_i)} \right]^{1/p} \dots \dots \dots (4.12)$$

where:

- $p=3$ For ball bearings
- $p=10/3$ For roller bearings

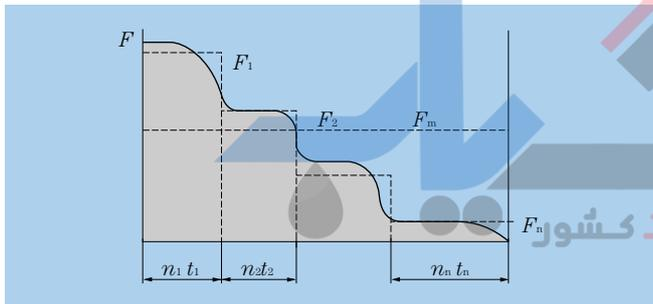

Fig. 4.8 Stepped load

(2) Continuously fluctuating load

Where it is possible to express the function $F(t)$ in terms of load cycle t_o and time t , the mean load is found by using formula (4.13).

$$F_m = \left[\frac{1}{t_o} \int_0^{t_o} F(t)^p d_t \right]^{1/p} \dots \dots \dots (4.13)$$

where:

- $p=3$ For ball bearings
- $p=10/3$ For roller bearings

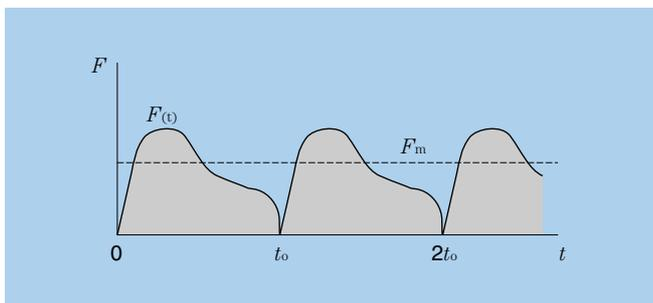

Fig. 4.9 Load that fluctuated as function of time

(3) Linear fluctuating load

The mean load, F_m , can be approximated by formula (4.14).

$$F_m = \frac{F_{min} + 2F_{max}}{3} \dots (4.14)$$

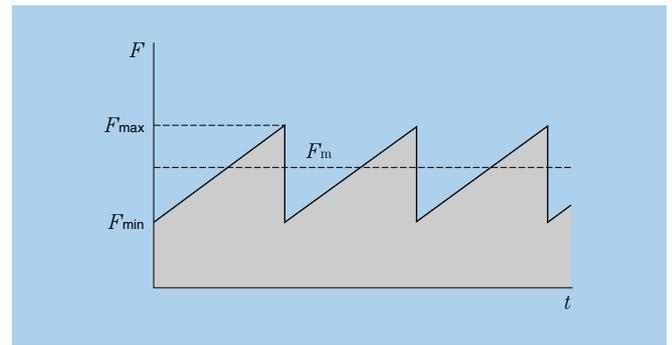

Fig. 4.10 Linear fluctuating load

(4) Sinusoidal fluctuating load

The mean load, F_m , can be approximated by formulas (4.15) and (4.16).

case (a) $F_m = 0.75 F_{max} \dots \dots \dots (4.15)$

case (b) $F_m = 0.65 F_{max} \dots \dots \dots (4.16)$

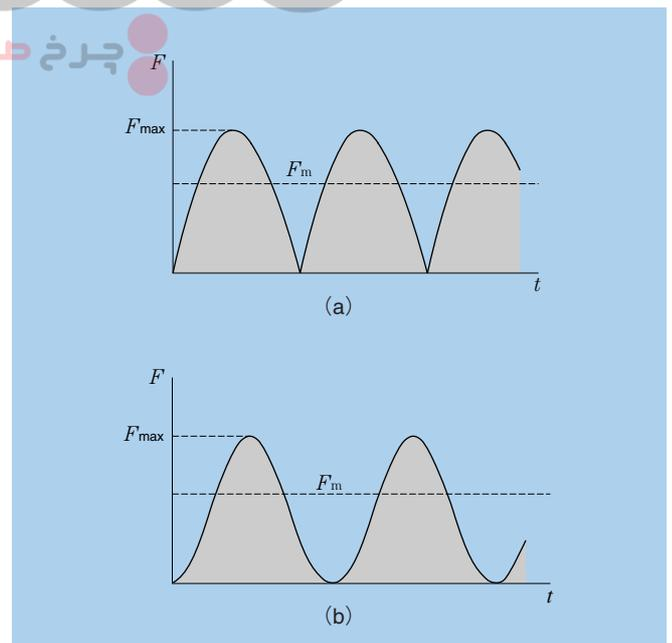

Fig. 4.11 Sinusoidal variable load

4.4 Equivalent load

4.4.1 Dynamic equivalent load

When both dynamic radial loads and dynamic axial loads act on a bearing at the same time, the hypothetical load acting on the center of the bearing which gives the bearings the same life as if they had only a radial load or only an axial load is called the dynamic equivalent load.

For radial bearings, this load is expressed as pure radial load and is called the dynamic equivalent radial load. For thrust bearings, it is expressed as pure axial load, and is called the dynamic equivalent axial load.

(1) Dynamic equivalent radial load

The dynamic equivalent radial load is expressed by formula (4.17).

$$P_r = XF_r + YF_a \dots \dots \dots (4.17)$$

where,

- P_r : Dynamic equivalent radial load, N {kgf}
- F_r : Actual radial load, N {kgf}
- F_a : Actual axial load, N {kgf}
- X : Radial load factor
- Y : Axial load factor

The values for X and Y are listed in the bearing tables.

(2) Dynamic equivalent axial load

As a rule, standard thrust bearings with a contact angle of 90° cannot carry radial loads. However, self-aligning thrust roller bearings can accept some radial load. The dynamic equivalent axial load for these bearings is given in formula (4.18).

$$P_a = F_a + 1.2F_r \dots \dots \dots (4.18)$$

where,

- P_a : Dynamic equivalent axial load, N {kgf}
- F_a : Actual axial load, N {kgf}
- F_r : Actual radial load, N {kgf}

Provided that $F_r / F_a \leq 0.55$ only.

4.4.2 Static equivalent load

The static equivalent load is a hypothetical load which would cause the same total permanent deformation at the most heavily stressed contact point between the rolling elements and the raceway as under actual load conditions; that is when both static radial loads and static axial loads are simultaneously applied to the bearing.

For radial bearings this hypothetical load refers to pure radial loads, and for thrust bearings it refers to pure centric axial loads. These loads are designated static equivalent radial loads and static equivalent axial loads respectively.

(1) Static equivalent radial load

For radial bearings the static equivalent radial load can be found by using formula (4.19) or (4.20). The greater of the two resultant values is always taken for P_{or} .

$$P_{or} = X_o F_r + Y_o F_a \dots \dots \dots (4.19)$$

$$P_{or} = F_r \dots \dots \dots (4.20)$$

where,

- P_{or} : Static equivalent radial load, N {kgf}
- F_r : Actual radial load, N {kgf}
- F_a : Actual axial load, N {kgf}
- X_o : Static radial load factor
- Y_o : Static axial load factor

The values for X_o and Y_o are given in the respective bearing tables.

(2) Static equivalent axial load

For spherical thrust roller bearings the static equivalent axial load is expressed by formula (4.21).

$$P_{oa} = F_a + 2.7F_r \dots \dots \dots (4.21)$$

where,

- P_{oa} : Static equivalent axial load, N {kgf}
- F_a : Actual axial load, N {kgf}
- F_r : Actual radial load, N {kgf}

Provided that $F_r / F_a \leq 0.55$ only.

4.4.3 Load calculation for angular contact ball bearings and tapered roller bearings

For angular contact ball bearings and tapered roller bearings the pressure cone apex (load center) is located as shown in Fig. 4.12, and their values are listed in the bearing tables.

When radial loads act on these types of bearings the component force is induced in the axial direction. For this reason, these bearings are used in pairs. For load calculation this component force must be taken into consideration and is expressed by formula (4.22).

$$F_a = \frac{0.5F_r}{Y} \dots \dots \dots (4.22)$$

where,

- F_a : Axial component force, N {kgf}
- F_r : Radial load, N {kgf}
- Y : Axial load factor

The dynamic equivalent radial loads for these bearing pairs are given in Table 4.5.

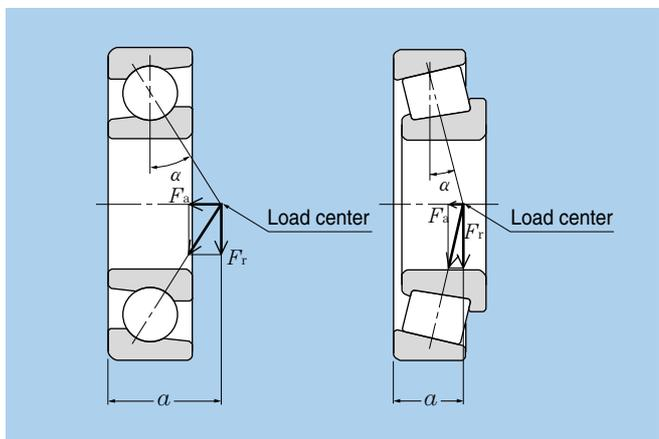
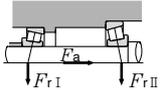
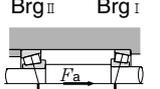
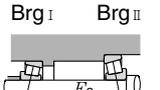
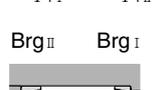

Fig. 4.12 Pressure cone apex and axial component force

Table 4.5 Bearing arrangement and dynamic equivalent load

Bearing arrangement	Load condition	Axial load
Rear Brg I Brg II 	$\frac{0.5F_{rI}}{Y_I} \leq \frac{0.5F_{rII}}{Y_{II}} + F_a$	$F_{aI} = \frac{0.5F_{rII}}{Y_{II}} + F_a$
Front Brg II Brg I 	$\frac{0.5F_{rI}}{Y_I} > \frac{0.5F_{rII}}{Y_{II}} + F_a$	$F_{aII} = \frac{0.5F_{rI}}{Y_I} - F_a$
Rear Brg I Brg II 	$\frac{0.5F_{rII}}{Y_{II}} \leq \frac{0.5F_{rI}}{Y_I} + F_a$	$F_{aII} = \frac{0.5F_{rI}}{Y_I} + F_a$
Front Brg II Brg I 	$\frac{0.5F_{rII}}{Y_{II}} > \frac{0.5F_{rI}}{Y_I} + F_a$	$F_{aI} = \frac{0.5F_{rII}}{Y_{II}} - F_a$

Note 1: Applies when preload is zero.

Note 2: Radial forces in the opposite direction to the arrow in the above illustration are also regarded as positive.

Note 3: Dynamic equivalent radial load is calculated by using the table on the right of the size table of the bearing after axial load is obtained for X and Y factor.

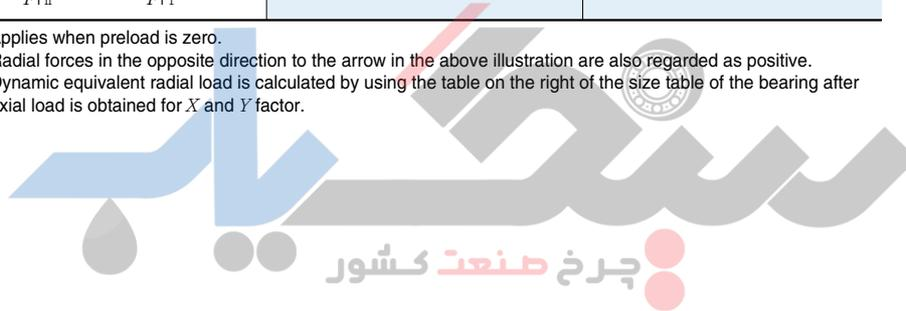

4.5 Bearing rating life and load calculation examples

In the examples given in this section, for the purpose of calculation, all hypothetical load factors as well as all calculated load factors may be presumed to be included in the resultant load values.

(Example 1)

What is the rating life in hours of operation (L_{10h}) for deep groove ball bearing **6208** operating at rotational speed $n = 650 \text{ min}^{-1}$, with a radial load F_r of 3.2 kN {326 kgf} ?

From formula (4.17) the dynamic equivalent radial load:

$$P_r = F_r = 3.2 \text{ kN} \quad \{326 \text{ kgf}\}$$

Basic dynamic load rating C_r for bearing 6208 given on page B-12 is 29.1 kN {2970 kgf}, ball bearing speed factor f_n relative to rotational speed $n = 650 \text{ min}^{-1}$ from **Fig. 3.1** is $f_n = 0.37$. Thus life factor f_h from formula (3.5) is:

$$f_h = f_n \frac{C_r}{P_r} = 0.37 \times \frac{29.1}{3.2} = 3.36$$

Therefore, with $f_h = 3.36$ from **Fig. 3.1** the rated life, L_{10h} , is approximately 19,000 hours.

(Example 2)

What is the life rating L_{10h} for the same bearing and conditions as in **Example 1**, but with an additional axial load F_a of 1.8 kN {184 kgf} ?

To find the dynamic equivalent radial load value for P_r , the radial load factor X and axial load factor Y are used. Basic static load rating C_{or} for bearing 6208 given on page B-12 is 17.8 kN {1820 kgf} and f_o is 14.0. Therefore:

$$\frac{f_o \cdot F_a}{C_{or}} = \frac{14 \times 1.8}{17.8} = 1.42$$

Calculating by the proportional interpolation method given on page B-13, $e = 0.30$.

For the operating radial load and axial load:

$$\frac{F_a}{F_r} = \frac{1.8}{3.2} = 0.56 > e = 0.30$$

From page B-13 $X = 0.56$ and $Y = 1.44$, and from formula (4.17) the equivalent radial load, P_r , is:

$$\begin{aligned} P_r &= XF_r + YF_a = 0.56 \times 3.2 + 1.43 \times 1.8 \\ &= 4.38 \text{ kN} \quad \{447 \text{ kgf}\} \end{aligned}$$

From **Fig. 3.1** and formula (3.1) the life factor, f_h , is:

$$f_h = f_n \frac{C_r}{P_r} = 0.37 \times \frac{29.1}{4.38} = 2.46$$

Therefore, with life factor $f_h = 2.46$, from **Fig. 3.1** the rated life, L_{10h} , is approximately 7,500 hours.

(Example 3)

Determine the optimum model number for a cylindrical roller bearing operating at the rotational speed $n = 450 \text{ min}^{-1}$, with a radial load F_r of 200 kN {20,400 kgf}, and which must have a life (L_{10h}) of over 20,000 hours.

From **Fig. 3.1** the life factor $f_h = 3.02$ (L_{10h} at 20,000), and the speed factor $f_n = 0.46$ ($n = 450 \text{ min}^{-1}$). To find the required basic dynamic load rating, C_r , formula (3.1) is used.

$$\begin{aligned} C_r &= \frac{f_h}{f_n} P_r = \frac{3.02}{0.46} \times 200 \\ &= 1,313 \text{ kN} \quad \{134,000 \text{ kgf}\} \end{aligned}$$

From page B-92, the smallest bearing that fulfills all the requirements is **NU2336** ($C_r = 1,380 \text{ kN}$ {141,000 kgf}).

(Example 4)

The spur gear shown in **Fig. 4.13** (pitch diameter $D_p = 150$ mm, pressure angle $\alpha = 20^\circ$) is supported by a pair of tapered roller bearings, 4T-32206 ($C_r = 54.5$ kN {5,600 kgf}) and 4T-32205 ($C_r = 42$ kN {4300 kgf}). Find rating life for each bearing when gear transfer power $H = 150$ kW and rotational speed $n = 2,000$ min⁻¹.

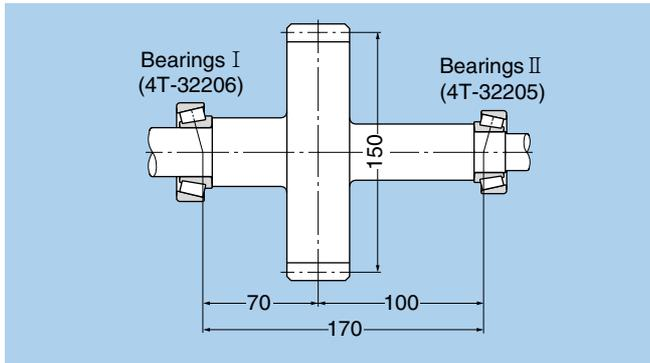

Fig. 4.13 Spur gear diagram

The gear load from formulas (4.2), (4.3a) and (4.4) is:

$$K_t = \frac{19.1 \times 10^6 \cdot H}{D_p \cdot n} = \frac{19,100 \times 150}{150 \times 2,000} = 9.55 \text{ kN } \{974 \text{ kgf}\}$$

$$K_s = K_t \cdot \tan \alpha = 9.55 \times \tan 20^\circ = 3.48 \text{ kN } \{355 \text{ kgf}\}$$

$$K_r = \sqrt{K_t^2 + K_s^2} = \sqrt{9.55^2 + 3.48^2} = 10.16 \text{ kN } \{1,040 \text{ kgf}\}$$

The radial loads for bearings I and II are:

$$F_{rI} = \frac{100}{170} K_r = \frac{100}{170} \times 10.16 = 5.98 \text{ kN } \{610 \text{ kgf}\}$$

$$F_{rII} = \frac{70}{170} K_r = \frac{70}{170} \times 10.16 = 4.18 \text{ kN } \{426 \text{ kgf}\}$$

$$\frac{0.5F_{rI}}{Y_I} = 1.87 > \frac{0.5F_{rII}}{Y_{II}} = 1.25$$

The axial loads for bearings I and II are:

$$F_{aI} = 0 \text{ kN } \{0 \text{ kgf}\}$$

$$F_{aII} = \frac{0.5F_{rI}}{Y_I} = \frac{0.5 \times 5.98}{1.60} = 1.87 \text{ kN } \{191 \text{ kgf}\}$$

From page B-129, the equivalent radial load for bearing I is:

$$\frac{F_{aI}}{F_{rI}} = \frac{0}{5.98} = 0 < e = 0.37$$

$$P_{rI} = F_{rI} = 5.98 \text{ kN } \{610 \text{ kgf}\}$$

Equally, the equivalent radial load for bearing II is:

$$\frac{F_{aII}}{F_{rII}} = \frac{1.87}{4.18} = 0.45 < e = 0.36$$

$$P_{rII} = X F_{rII} + Y_{II} F_{aII} = 0.4 \times 4.18 + 1.67 \times 1.87 = 4.79 \text{ kN } \{489 \text{ kgf}\}$$

From formula (3.5) and **Fig. 3.1** the life factor, f_h , for each bearing is

$$f_{hI} = f_a \frac{C_{rI}}{P_{rI}} = 0.293 \times 54.5 / 5.98 = 2.67$$

$$f_{hII} = f_a \frac{C_{rII}}{P_{rII}} = 0.293 \times 42.0 / 4.79 = 2.57$$

Therefore: $a_2 = 1.4$ (4T-tapered roller bearings shown in **B-130**)

$$L_{h1} = 13,200 \times a_2 = 13,200 \times 1.4 = 18,480 \text{ hour}$$

$$L_{h2} = 11,600 \times a_2 = 11,600 \times 1.4 = 16,240 \text{ hour}$$

The combined bearing life, L_h , from formula (3.3) is:

$$L_h = \frac{1}{\left[\frac{1}{L_{h1}^e} + \frac{1}{L_{h2}^e} \right]^{1/e}}$$

$$= \frac{1}{\left[\frac{1}{18,480^{9/8}} + \frac{1}{16,240^{9/8}} \right]^{8/9}} = 9,330 \text{ hour}$$

(Example 5)

Find the mean load for spherical roller bearing **23932** ($L_a = 320 \text{ kN}$ {33,000 kgf}) when operated under the fluctuating conditions shown in **Table 4.6**.

Table 4.6

Condition No. i	Operating time ϕ_i %	Radial load F_{ri} kN { kgf }	Axial load F_{ai} kN { kgf }	Revolution n_i min ⁻¹
1	5	10 { 1020 }	2 { 204 }	1200
2	10	12 { 1220 }	4 { 408 }	1000
3	60	20 { 2040 }	6 { 612 }	800
4	15	25 { 2550 }	7 { 714 }	600
5	10	30 { 3060 }	10 { 1020 }	400

The equivalent radial load, P_r , for each operating condition is found by using formula (4.17) and shown in **Table 4.7**. Because all the values for F_{ri} and F_{ai} from the bearing tables are greater than $F_a / F_r > e = 0.18$, $X = 0.67$, $Y_2 = 5.50$.

$$P_{ri} = X F_{ri} + Y_2 F_{ai} = 0.67 F_{ri} + 5.50 F_{ai}$$

From formula (4.12) the mean load, F_m , is:

$$F_m = \left[\frac{\sum (P_{ri}^{10/3} \cdot n_i \cdot \phi_i)}{\sum (n_i \cdot \phi_i)} \right]^{3/10} = 48.1 \text{ kN} \{ 4,906 \text{ kgf} \}$$

Table 4.7

Condition No. i	Equivalent radial load. P_{ri} kN { kgf }
1	17.7 { 1805 }
2	30.0 { 3060 }
3	46.4 { 4733 }
4	55.3 { 5641 }
5	75.1 { 7660 }

(Example 6)

Find the threshold values for rating life time and allowable axial load when cylindrical roller bearing NUP312 is used under the following conditions: Provided that intermittent axial load and oil lubricant.

Radial load $F_r = 10 \text{ kN}$ {1,020 kgf}

Rotational speed $n = 2,000 \text{ min}^{-1}$

Radial load is:

$$P_r = F_r = 10 \text{ kN} \{ 1,020 \text{ kgf} \}$$

The speed factor of cylindrical roller bearing, f_n , at $n = 2,000 \text{ min}^{-1}$, from **Table 3.1**

$$f_n = \left[\frac{33.3}{2,000} \right]^{3/10} = 0.293$$

The life factor, f_h , from formula (3.4)

$$f_h = 0.293 \times \frac{124}{10} = 3.63$$

Therefore the basic rated life, L_{10h} , from **Table 3.1**

$$L_{10h} = 500 \times 3.63^{10/3} \approx 37,000$$

And next, allowable axial load of cylindrical roller bearing is shown in page B-79.

In formula (1) on page B-79, based on NUP312 from Table 4 on page B-79, $k = 0.065$.

$$d_p = (60 + 130) / 2 = 95 \text{ mm}, n = 2,000 \text{ min}^{-1}$$

Take into consideration that intermittent axial load.

$$d_p \cdot n \times 10^4 = 19 \times 10^4$$

In **Fig. 1** on page B-79, $d_p \cdot n = 19 \times 10^4$. In the case of intermittent axial load, allowable surface pressure at the lip $P_t = 40 \text{ MPa}$.

Therefore the allowable axial load, P_t , following

$$P_z = 0.065 \times 60^2 \times 40 = 9,360 \text{ N} \{ 954 \text{ kgf} \}$$

Based on **Table 4** of page B-79, it is within the limits of $F_{a \text{ max}} < 0.4 \times 10,000 = 4,000 \text{ N}$. Therefore $P_t < 4,000 \text{ N}$ {408 kgf}.

5. Boundary Dimensions and Bearing Number Codes

5.1 Boundary dimensions

A rolling bearing's major dimensions, known as "boundary dimensions," are shown in **Figs. 5.1 - 5.3**. To facilitate international bearing interchangeability and economical bearing production, bearing boundary dimensions have been standardized by the International Standards Organization (ISO). In Japan, rolling bearing boundary dimensions are regulated by Japanese Industrial Standards (JIS B 1512).

Those boundary dimensions which have been standardized include: bearing bore diameter, outside diameter, width/height, and chamfer dimensions - all important dimensions when considering the compatibility of shafts, bearings, and housings. However, as a general rule,

bearing internal construction dimensions are not covered by these dimensions.

For metric series rolling bearings there are 90 standardized bore diameters (d) ranging in size from 0.6mm - 2,500mm.

Outer diameter dimensions (D) for radial bearings with standardized bore diameter dimensions are covered in the "diameter series;" their corresponding width dimensions (B) are covered in the "width series." For thrust bearings there is no width series; instead, these dimensions are covered in the "height series." The combination of all these series is known as the "dimension series." All series numbers are shown in **Table 5.1**.

Although many rolling bearing dimensions are standardized, and have been listed here for purposes of

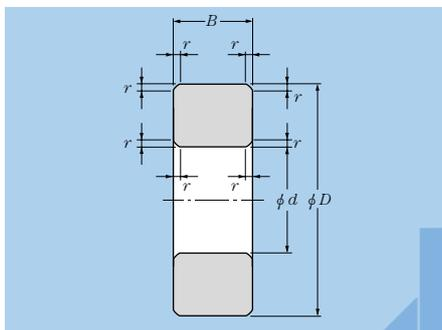

Fig. 5.1 Radial bearings (excluding tapered roller bearings)

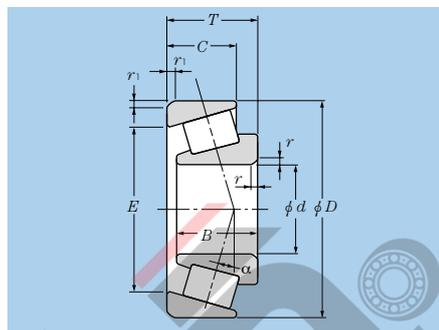

Fig. 5.2 Tapered roller bearings

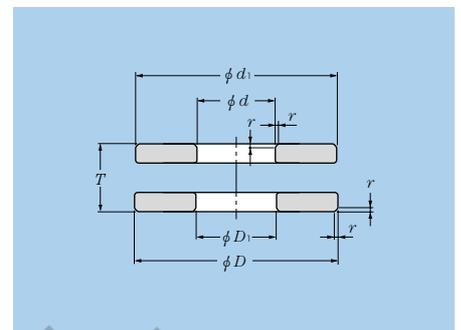

Fig. 5.3 Single direction thrust bearings

Table 5.1 Dimension series numbers

	Dimension series			Reference diagram
	Diameter series (outer diameter dimensions)	Width series (width dimensions)	Height series (height dimensions)	
Radial bearings (excluding tapered roller bearings)	number	7, 8, 9, 0, 1, 2, 3, 4	8, 0, 1, 2, 3, 4, 5, 6	Diagram 5.4
	dimensions	small ← → large	small ← → large	
Tapered roller bearings	number	9, 0, 1, 2, 3	0, 1, 2, 3	Diagram 5.5
	dimensions	small ← → large	small ← → large	
Thrust bearings	number	0, 1, 2, 3, 4		Diagram 5.6
	dimensions	small ← → large	small ↔ large	

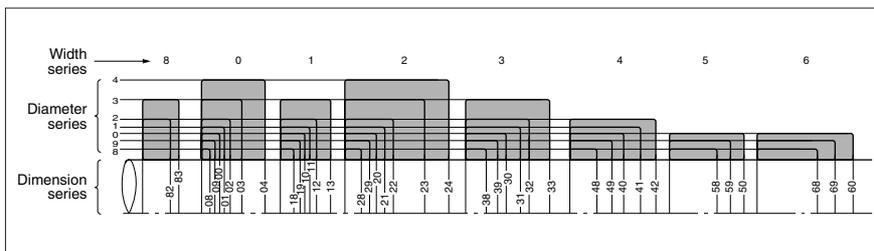

Fig. 5.4 Dimension series for radial bearings (excluding tapered roller bearings; diameter series 7 has been omitted)

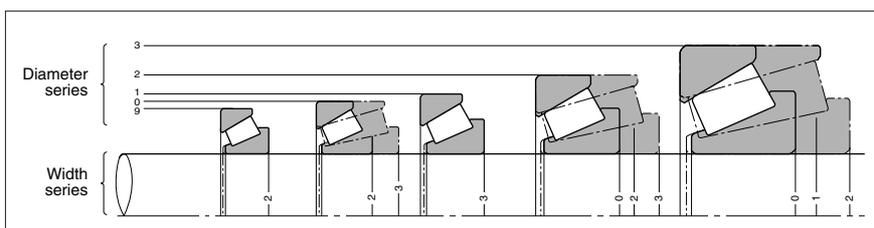

Fig. 5.5 Dimension series for tapered roller bearings

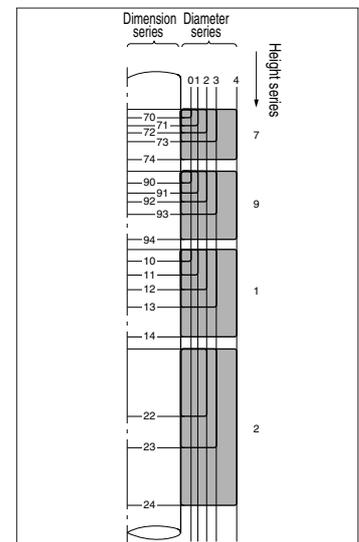

Fig. 5.6 Dimension series for thrust bearings (excluding diameter series 5)

future standardization, there are many standard bearing dimensions which are not presently manufactured.

Boundary dimensions for radial bearings (excluding tapered roller bearings) are shown in the attached tables.

5.2 Bearing numbers

Rolling bearing part numbers indicate bearing type, dimensions, tolerances, internal construction, and other related specifications. Bearing numbers are comprised of a

"basic number" followed by "supplementary codes." The makeup and order of bearing numbers is shown in **Table 5.2**.

The basic number indicates general information about a bearing, such as its fundamental type, boundary dimensions, series number, bore diameter code and contact angle. The supplementary codes derive from prefixes and suffixes which indicate a bearing's tolerances, internal clearances, and related specifications.

(Bearing number examples)

6205ZZC3 / 2AS

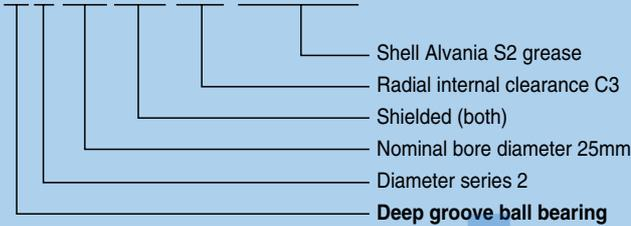

23034BD1

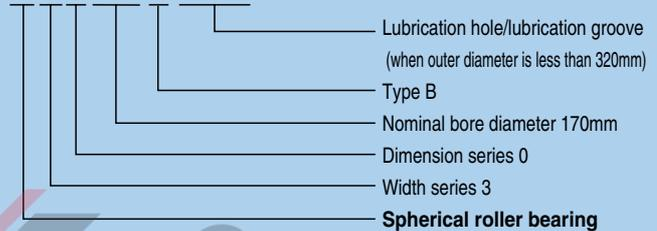

7012BDB / GMP6

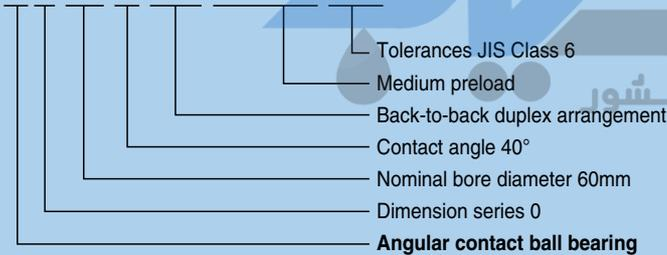

240 / 750BK30

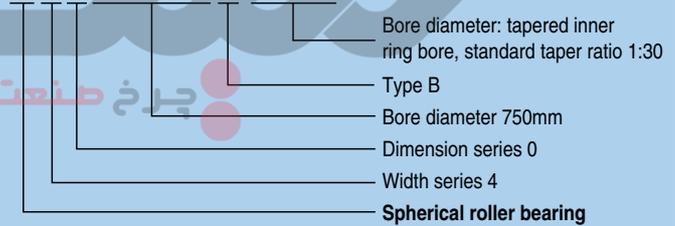

NU320G1C3

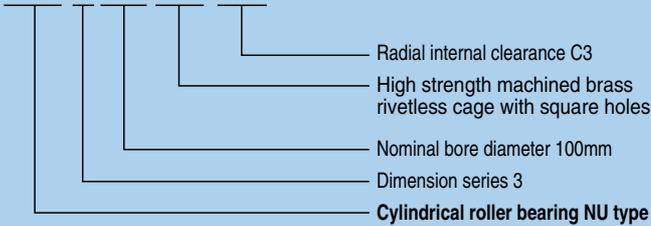

51120L1P5

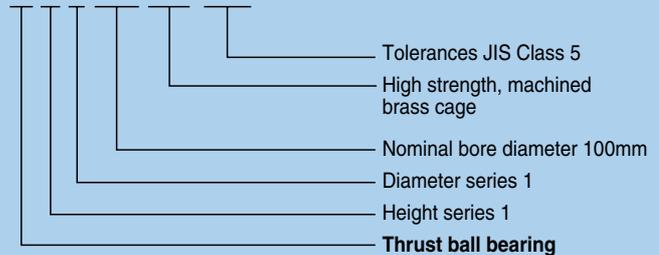

4T - 30208



Table 5.2 Bearing number composition and arrangement

Supplementary prefix code Special application/material/ heat treatment code	Basic number						
	Bearing series			Bore diameter code		Contact angle code	
	Bearing series code	Dimension series code		Code	bore diameter mm	Code ^①	Contact angle
Width/height series ^①		Diameter series					
4T: 4T tapered roller bearings	Deep groove ball bearings (type code 6)			/0.6	0.6	Angular contact ball bearings	
ET: ET tapered roller bearings	68	(1)	8	/1.5	1.5	(A)	Standard contact angle 30°
ETA: ET+special heat treatment	69	(1)	9	/2.5	2.5	B	Standard contact angle 40°
E: Bearing using case hardened steel	60	(1)	0			C	Standard contact angle 15°
EA: Bearing made of nitride-treated case hardened steel	62	(0)	2	1	1	Tapered roller bearings	
TA: Bearing made of nitride-treated bearing steel (SUJ3)	63	(0)	3	:	:	(B)	Contact angle over 10°
	Angular contact ball bearings (type code 7)			9	9	C	Contact angle over 17° to/including 17°
	78	(1)	8	00	10	D	Contact angle over 17° to/including 24°
	79	(1)	9	01	12		Contact angle over 24° to/including 32°
	70	(1)	0	02	15		
	72	(0)	2	03	17		
	73	(0)	3				
	Self-aligning ball bearings (type code 1,2)						
	12	(0)	2				
	13	(0)	3				
	Cylindrical roller bearings (type code NU, N, NF, NNU, NN, etc.)						
	22	(2)	2	/22	22		
	23	(2)	3	/28	28		
				/32	32		
	NU10	1	0	04	20		
	NU2	(0)	2	05	25		
	NU22	2	2	06	30		
	NU3	(0)	3	:	:		
	NU23	2	3	88	440		
	NU4	(0)	4	92	460		
	NNU49	4	9	96	480		
	NN30	3	0				
	Tapered roller bearings (type code 3)						
	329X	2	9	/500	500		
	320X	2	0	/530	530		
	302	0	2	/560	560		
	322	2	2	:	:		
	303	0	3	/2,360	2,360		
	303D	0	3	/2,500	2,500		
	313X	1	3				
	323	2	3				
	Spherical roller bearings (type code 2)						
	239	3	9				
	230	3	0				
	240	4	0				
	231	3	1				
	241	4	1				
	222	2	2				
	232	3	2				
	213	1	3				
	223	2	3				
	Single direction thrust ball bearings (type code 5)						
	511	1	1				
	512	1	2				
	513	1	3				
	514	1	4				
	Cylindrical roller thrust bearings (type code 8)						
	811	1	1				
	812	1	2				
	893	9	3				
	Spherical thrust roller bearings (type code 2)						
	292	9	2				
	293	9	3				
	294	9	4				

① Codes in () are not shown in nominal numbers.

Note: Please consult NTN Engineering concerning bearing series codes, and supplementary prefix/suffix codes not listed in the above table.

Supplementary suffix codes							
Internal modifications code	cage code	Seal / Shield code	External configuration code	Duplex arrangement code	Internal clearance /preload code	Tolerance code	Lubrication code
U: Internationally interchangeable tapered roller bearings	L1: High strength, machined brass cage	LLB: Synthetic rubber seal (non-contact type)	K: Tapered inner ring bore, standard taper ratio 1:12	DB: Back-to-back arrangement	C2: Internal clearance less than normal	P6: JIS Class 6	/2AS: Shell Alvania S2 grease
R: Non-internationally interchangeable tapered roller bearings	F1: Machined carbon steel cage	LLU: Synthetic rubber seal (contact type)	K30: Tapered inner ring bore, standard taper ratio 1:30	DF: Face-to-face arrangement	(CN): Normal clearance	P5: JIS Class 5	/3AS: Shell Alvania S3 grease
ST: Low torque tapered roller bearings	G1: High strength machined brass rivetless cage with square holes,	LLH: Synthetic rubber seal (low-torque type)	N: With snap ring groove	DT: Tandem arrangement	C3: Internal clearance greater than normal	P4: JIS Class 4	/8A: Shell Alvania EP2 grease
HT: High axial load use cylindrical roller bearings	G2: Pin type cage	ZZ: Steel shield	NR: With snap ring	D2: Two matched, paired bearings	C4: Internal clearance greater than C3	P2: JIS Class 2	/5K: MULTEMP SRL
	J: Pressed steel cage		D: With oil hole	G: Flush ground	C5: Internal clearance greater than C4	2: ABMA Class 2	/LX11: Barierta JFE552
	T2: Plastic mold cage		D1: Lubrication hole/lubrication groove	+ α : Spacer (α = spacer's standard width dimensions)	CM: Radial internal clearance for electric motor use	3: ABMA Class 3	/LP03: Thermosetting grease (grease for poly-lube bearings)
					/GL: Light preload	0: ABMA Class 0	
					/GN: Normal preload	00: ABMA Class 00	
					/GM: Medium preload		
					/GH: Heavy preload		



6. Bearing Tolerances

6.1 Dimensional accuracy and running accuracy

Bearing "tolerances" or dimensional accuracy and running accuracy, are regulated by ISO and JIS B 1514 standards (rolling bearing tolerances). For dimensional accuracy, these standards prescribe the tolerances necessary when installing bearings on shafts or in housings. Running accuracy is defined as the allowable limits for bearing runout during operation.

Dimensional accuracy

Dimensional accuracy constitutes the acceptable values for bore diameter, outer diameter, assembled bearing width, and bore diameter uniformity as seen in chamfer dimensions, allowable inner ring tapered bore deviation and shape error. Also included are, average bore diameter variation, outer diameter variation, average outer diameter unevenness, as well as raceway width and height variation (for thrust bearings).

Running accuracy

Running accuracy constitutes the acceptable values for inner and outer ring radial runout and axial runout, inner ring side runout, and outer ring outer diameter runout.

Allowable rolling bearing tolerances have been established according to precision classes. Bearing precision is stipulated as JIS class 6, class 5, class 4, or class 2, with precision rising from ordinary precision indicated by class 0.

Table 6.1 indicates which standards and precision classes are applicable to the major bearing types. **Table 6.2** shows a relative comparison between JIS B 1514 precision class standards and other standards. For greater detail on allowable limitations and values, refer to **Tables 6.3 - 6.8**. Allowable values for chamfer dimensions are shown in **Table 6.9**, and allowable limitations and values for radial bearing inner ring tapered bores are shown in **Table 6.10**.

Table 6.1 Bearing types and applicable tolerance

Bearing type		Applicable standard	Tolerance class					Tolerance table
Deep groove ball bearings		JIS B 1514 (ISO492)	class 0	class 6	class 5	class 4	class 2	Table 6.3
Angular contact ball bearings			class 0	class 6	class 5	class 4	class 2	
Self-aligning ball bearings			class 0	—	—	—	—	
Cylindrical roller bearings			class 0	class 6	class 5	class 4	class 2	
Needle roller bearings			class 0	class 6	class 5	class 4	—	
Spherical roller bearings			class 0	—	—	—	—	
Tapered roller bearings	metric	JIS B 1514	class 0,6X	class 6	class 5	class 4	—	Table 6.4
	Inch	ANSI/ABMA Std.19	class 4	class 2	class 3	class 0	class 00	Table 6.5
	J series	ANSI/ABMA Std.19.1	class K	class N	class C	class B	class A	Table 6.6
Thrust ball bearings		JIS B 1514 (ISO199)	class 0	class 6	class 5	class 4	—	Table 6.7
Spherical roller thrust bearings			class 0	—	—	—	—	Table 6.8

Table 6.2 Comparison of tolerance classifications of national standards

Standard	Applicable standard	Tolerance Class					Bearing Types
Japanese industrial standard (JIS)	JIS B 1514	Class 0,6X	Class 6	Class 5	Class 4	Class 2	All type
International Organization for Standardization (ISO)	ISO 492	Normal class Class 6X	Class 6	Class 5	Class 4	Class 2	Radial bearings
	ISO 199	Normal Class	Class 6	Class 5	Class 4	—	Thrust ball bearings
	ISO 578	Class 4	—	Class 3	Class 0	Class 00	Tapered roller bearings (Inch series)
	ISO 1224	—	—	Class 5A	Class 4A	—	Precision instrument bearings
Deutsches Institut für Normung (DIN)	DIN 620	P0	P6	P5	P4	P2	All type
American National Standards Institute (ANSI)	ANSI/ABMA Std.20 ^①	ABEC-1 RBEC-1	ABEC-3 RBEC-3	ABEC-5 RBEC-5	ABEC-7	ABEC-9	Radial bearings (Except tapered roller bearings)
American Bearing Manufacturer's Association (ABMA)	ANSI/ABMA Std.19.1	Class K	Class N	Class C	Class B	Class A	Tapered roller bearings (Metric series)
	ANSI/ABMA Std.19	Class 4	Class 2	Class 3	Class 0	Class 00	Tapered roller bearings (Inch series)

① "ABEC" is applied for ball bearings and "RBEC" for roller bearings.

Notes 1: JIS B 1514, ISO 492 and 199, and DIN 620 have the same specification level.

2: The tolerance and allowance of JIS B 1514 are a little different from those of ABMA standards.

Table 6.3 Tolerance of radial bearings (Except tapered roller bearings)

Table 6.3 (1) Inner rings

Nominal bore diameter <i>d</i> mm		Dimensional tolerance of mean bore diameter within plane Δd_{mp}										Bore diameter variation V_{dp}														
												diameter series 9					diameter series 0.1					diameter series 2.3.4				
		class 0	class 6		class 5		class 4 ^①		class 2 ^①		class 0	class 6	class 5	class 4	class 2	class 0	class 6	class 5	class 4	class 2						
over	incl.	high	low	high	low	high	low	high	low	high	low	high	low	high	low	high	low	high	low							
												max					max					max				
0.6 ^②	2.5	0	-8	0	-7	0	-5	0	-4	0	-2.5	10	9	5	4	2.5	8	7	4	3	2.5	6	5	4	3	2.5
2.5	10	0	-8	0	-7	0	-5	0	-4	0	-2.5	10	9	5	4	2.5	8	7	4	3	2.5	6	5	4	3	2.5
10	18	0	-8	0	-7	0	-5	0	-4	0	-2.5	10	9	5	4	2.5	8	7	4	3	2.5	6	5	4	3	2.5
18	30	0	-10	0	-8	0	-6	0	-5	0	-2.5	13	10	6	5	2.5	10	8	5	4	2.5	8	6	5	4	2.5
30	50	0	-12	0	-10	0	-8	0	-6	0	-2.5	15	13	8	6	2.5	12	10	6	5	2.5	9	8	6	5	2.5
50	80	0	-15	0	-12	0	-9	0	-7	0	-4	19	15	9	7	4	19	15	7	5	4	11	9	7	5	4
80	120	0	-20	0	-15	0	-10	0	-8	0	-5	25	19	10	8	5	25	19	8	6	5	15	11	8	6	5
120	150	0	-25	0	-18	0	-13	0	-10	0	-7	31	23	13	10	7	31	23	10	8	7	19	14	10	8	7
150	180	0	-25	0	-18	0	-13	0	-10	0	-7	31	23	13	10	7	31	23	10	8	7	19	14	10	8	7
180	250	0	-30	0	-22	0	-15	0	-12	0	-8	38	28	15	12	8	38	28	12	9	8	23	17	12	9	8
250	315	0	-35	0	-25	0	-18	—	—	—	—	44	31	18	—	—	44	31	14	—	—	26	19	14	—	—
315	400	0	-40	0	-30	0	-23	—	—	—	—	50	38	23	—	—	50	38	18	—	—	30	23	18	—	—
400	500	0	-45	0	-35	—	—	—	—	—	—	56	44	—	—	—	56	44	—	—	—	34	26	—	—	—
500	630	0	-50	0	-40	—	—	—	—	—	—	63	50	—	—	—	63	50	—	—	—	38	30	—	—	—
630	800	0	-75	—	—	—	—	—	—	—	—	—	—	—	—	—	—	—	—	—	—	—	—	—	—	—
800	1 000	0	-100	—	—	—	—	—	—	—	—	—	—	—	—	—	—	—	—	—	—	—	—	—	—	—
1 000	1 250	0	-125	—	—	—	—	—	—	—	—	—	—	—	—	—	—	—	—	—	—	—	—	—	—	—
1 250	1 600	0	-160	—	—	—	—	—	—	—	—	—	—	—	—	—	—	—	—	—	—	—	—	—	—	—
1 600	2 000	0	-200	—	—	—	—	—	—	—	—	—	—	—	—	—	—	—	—	—	—	—	—	—	—	—

① The dimensional difference Δd_s of bore diameter to be applied for class 4 and 2 is the same as the tolerance of dimensional difference Δd_{mp} of average bore diameter. However, the dimensional difference is applied to diameter series 0, 1, 2, 3 and 4 against Class 4, and to all the diameter series against Class 2.

Table 6.3 (2) Outer rings

Nominal outside diameter <i>D</i> mm		Dimensional tolerance of mean outside diameter within plane ΔD_{mp}										Outside diameter variation ^⑥ V_{Dp}														
												diameter series 9					diameter series 0.1					diameter series 2.3.4				
		class 0	class 6		class 5		class 4 ^⑤		class 2 ^⑤		class 0	class 6	class 5	class 4	class 2	class 0	class 6	class 5	class 4	class 2						
over	incl.	high	low	high	low	high	low	high	low	high	low	high	low	high	low	high	low	high	low							
												max					max					max				
2.5 ^⑧	6	0	-8	0	-7	0	-5	0	-4	0	-2.5	10	9	5	4	2.5	8	7	4	3	2.5	6	5	4	3	2.5
6	18	0	-8	0	-7	0	-5	0	-4	0	-2.5	10	9	5	4	2.5	8	7	4	3	2.5	6	5	4	3	2.5
18	30	0	-9	0	-8	0	-6	0	-5	0	-4	12	10	6	5	4	9	8	5	4	4	7	6	5	4	4
30	50	0	-11	0	-9	0	-7	0	-6	0	-4	14	11	7	6	4	11	9	5	5	4	8	7	5	5	4
50	80	0	-13	0	-11	0	-9	0	-7	0	-4	16	14	9	7	4	13	11	7	5	4	10	8	7	5	4
80	120	0	-15	0	-13	0	-10	0	-8	0	-5	19	16	10	8	5	19	16	8	6	5	11	10	8	6	5
120	150	0	-18	0	-15	0	-11	0	-9	0	-5	23	19	11	9	5	23	19	8	7	5	14	11	8	7	5
150	180	0	-25	0	-18	0	-13	0	-10	0	-7	31	23	13	10	7	31	23	10	8	7	19	14	10	8	7
180	250	0	-30	0	-20	0	-15	0	-11	0	-8	38	25	15	11	8	38	25	11	8	8	23	15	11	8	8
250	315	0	-35	0	-25	0	-18	0	-13	0	-8	44	31	18	13	8	44	31	14	10	8	26	19	14	10	8
315	400	0	-40	0	-28	0	-20	0	-15	0	-10	50	35	20	15	10	50	35	15	11	10	30	21	15	11	10
400	500	0	-45	0	-33	0	-23	—	—	—	—	56	41	23	—	—	56	41	17	—	—	34	25	17	—	—
500	630	0	-50	0	-38	0	-28	—	—	—	—	63	48	28	—	—	63	48	21	—	—	38	29	21	—	—
630	800	0	-75	0	-45	0	-35	—	—	—	—	94	56	35	—	—	94	56	26	—	—	55	34	26	—	—
800	1 000	0	-100	0	-60	—	—	—	—	—	—	125	75	—	—	—	125	75	—	—	—	75	45	—	—	—
1 000	1 250	0	-125	—	—	—	—	—	—	—	—	—	—	—	—	—	—	—	—	—	—	—	—	—	—	—
1 250	1 600	0	-160	—	—	—	—	—	—	—	—	—	—	—	—	—	—	—	—	—	—	—	—	—	—	—
1 600	2 000	0	-200	—	—	—	—	—	—	—	—	—	—	—	—	—	—	—	—	—	—	—	—	—	—	—
2 000	2 500	0	-250	—	—	—	—	—	—	—	—	—	—	—	—	—	—	—	—	—	—	—	—	—	—	—

⑤ The dimensional difference ΔD_s of outer diameter to be applied for classes 4 and 2 is the same as the tolerance of dimensional difference ΔD_{mp} of average outer diameter. However, the dimensional difference is applied to diameter series 0, 1, 2, 3 and 4 against Class 4, and also to all the diameter series against Class 2.

Unit μm

Mean bore diameter variation V_{Dmp}	Inner ring radial runout K_{Ia}	Side runout with bore S_d	Inner ring axial runout S_{Ia} ^②	Inner ring width deviation Δ_{Bs}										Inner ring width variation V_{Bs}																		
				normal					modified ^③																							
				class 0,6		class 5,4		class 2	class 0,6		class 5,4																					
class 0	class 6	class 5	class 4	class 2	class 0	class 6	class 5	class 4	class 2	class 0	class 6	class 5	class 4	class 2																		
max					max					max					max																	
6	5	3	2	1.5	10	5	4	2.5	1.5	7	3	1.5	7	3	1.5	0	-40	0	-40	0	-40	—	—	0	-250	12	12	5	2.5	1.5		
6	5	3	2	1.5	10	6	4	2.5	1.5	7	3	1.5	7	3	1.5	0	-120	0	-40	0	-40	0	-250	0	-250	0	-250	15	15	5	2.5	1.5
6	5	3	2	1.5	10	7	4	2.5	1.5	7	3	1.5	7	3	1.5	0	-120	0	-80	0	-80	0	-250	0	-250	20	20	5	2.5	1.5		
8	6	3	2.5	1.5	13	8	4	3	2.5	8	4	1.5	8	4	2.5	0	-120	0	-120	0	-120	0	-250	0	-250	20	20	5	2.5	1.5		
9	8	4	3	1.5	15	10	5	4	2.5	8	4	1.5	8	4	2.5	0	-120	0	-120	0	-120	0	-250	0	-250	20	20	5	3	1.5		
11	9	5	3.5	2	20	10	5	4	2.5	8	5	1.5	8	5	2.5	0	-150	0	-150	0	-150	0	-380	0	-250	25	25	6	4	1.5		
15	11	5	4	2.5	25	13	6	5	2.5	9	5	2.5	9	5	2.5	0	-200	0	-200	0	-200	0	-380	0	-380	25	25	7	4	2.5		
19	14	7	5	3.5	30	18	8	6	2.5	10	6	2.5	10	7	2.5	0	-250	0	-250	0	-250	0	-500	0	-380	30	30	8	5	2.5		
19	14	7	5	3.5	30	18	8	6	5	10	6	4	10	7	5	0	-250	0	-250	0	-250	0	-500	0	-380	30	30	8	5	4		
23	17	8	6	4	40	20	10	8	5	11	7	5	13	8	5	0	-300	0	-300	0	-300	0	-500	0	-500	30	30	10	6	5		
26	19	9	—	—	50	25	13	—	—	13	—	—	15	—	—	0	-350	0	—	—	—	0	-500	0	—	35	35	13	—	—		
30	23	12	—	—	60	30	15	—	—	15	—	—	20	—	—	0	-400	0	—	—	—	0	-630	0	—	40	40	15	—	—		
34	26	—	—	—	65	35	—	—	—	—	—	—	—	—	—	0	-450	—	—	—	—	—	—	—	—	50	45	—	—	—		
38	30	—	—	—	70	40	—	—	—	—	—	—	—	—	—	0	-500	—	—	—	—	—	—	—	—	60	50	—	—	—		
55	—	—	—	—	80	—	—	—	—	—	—	—	—	—	—	0	—	—	—	—	—	—	—	—	—	70	—	—	—	—		
75	—	—	—	—	90	—	—	—	—	—	—	—	—	—	—	0	—	—	—	—	—	—	—	—	—	80	—	—	—	—		
94	—	—	—	—	100	—	—	—	—	—	—	—	—	—	—	0	—	—	—	—	—	—	—	—	—	100	—	—	—	—		
120	—	—	—	—	120	—	—	—	—	—	—	—	—	—	—	0	—	—	—	—	—	—	—	—	—	120	—	—	—	—		
150	—	—	—	—	140	—	—	—	—	—	—	—	—	—	—	0	—	—	—	—	—	—	—	—	—	140	—	—	—	—		

② Applies to ball bearings such as deep groove ball bearings and angular ball bearings.

③ To be applied for individual raceway rings manufactured for combined bearing use.

④ Nominal bore diameter of bearings of 0.6 mm is included in this dimensional division.

Unit μm

Outside diameter variation V_{DF} ^⑥ Sealed/shield bearings diameter series	Mean bore diameter variation V_{Dmp}	Outer ring radial runout K_{Ea}	Outside surface inclination S_b	Outside ring axial runout S_{Ea} ^⑦	Outer ring width deviation Δ_{Cs}	Outer ring width variation V_{Cs}																
2,3,4 class 0	0,1,2,3,4 class 6	class 0	class 6	class 5	class 4	class 2	class 0	class 6	class 5	class 4	class 2	class 5	class 4	class 2	class 5	class 4	class 2	class 0,6	class 5	class 4	class 2	
max		max					max					max					max					
10	9	6	5	3	2	1.5	15	8	5	3	1.5	8	4	1.5	8	5	1.5	Depends on tolerance of Δ_{Bs} in relation to d of same bearing	Depends on tolerance of Δ_{Bs} in relation to d of same bearing	5	2.5	1.5
10	9	6	5	3	2	1.5	15	8	5	3	1.5	8	4	1.5	8	5	1.5			5	2.5	1.5
12	10	7	6	3	2.5	2	15	9	6	4	2.5	8	4	1.5	8	5	2.5			5	2.5	1.5
16	13	8	7	4	3	2	20	10	7	5	2.5	8	4	1.5	8	5	2.5			5	2.5	1.5
20	16	10	8	5	3.5	2	25	13	8	5	4	8	4	1.5	10	5	4			6	3	1.5
26	20	11	10	5	4	2.5	35	18	10	6	5	9	5	2.5	11	6	5			8	4	2.5
30	25	14	11	6	5	2.5	40	20	11	7	5	10	5	2.5	13	7	5			8	5	2.5
38	30	19	14	7	5	3.5	45	23	13	8	5	10	5	2.5	14	8	5			8	5	2.5
—	—	23	15	8	6	4	50	25	15	10	7	11	7	4	15	10	7			10	7	4
—	—	26	19	9	7	4	60	30	18	11	7	13	8	5	18	10	7			11	7	5
—	—	30	21	10	8	5	70	35	20	13	8	13	10	7	20	13	8			13	8	7
—	—	34	25	12	—	—	80	40	23	—	—	15	—	—	23	—	—			15	—	—
—	—	38	29	14	—	—	100	50	25	—	—	18	—	—	25	—	—			18	—	—
—	—	55	34	18	—	—	120	60	30	—	—	20	—	—	30	—	—			20	—	—
—	—	75	45	—	—	—	140	75	—	—	—	—	—	—	—	—	—			—	—	—
—	—	—	—	—	—	—	160	—	—	—	—	—	—	—	—	—	—	—	—	—		
—	—	—	—	—	—	—	190	—	—	—	—	—	—	—	—	—	—	—	—	—		
—	—	—	—	—	—	—	220	—	—	—	—	—	—	—	—	—	—	—	—	—		
—	—	—	—	—	—	—	250	—	—	—	—	—	—	—	—	—	—	—	—	—		

⑥ To be applied in case snap rings are not installed on the bearings.

⑦ Applies to ball bearings such as deep groove ball bearings and angular ball bearings.

⑧ Nominal outer diameter of bearings of 2.5 mm is included in this dimensional division.

Table 6.4 Tolerance of tapered roller bearings (Metric series)

Table 6.4 (1) Inner rings

Nominal bore diameter <i>d</i> mm		Dimensional tolerance of mean bore diameter within plane Δ_{dmp}						Bore diameter variation V_{dp}				Mean bore diameter variation V_{dmp}				Inner ring radial runout K_{ia}				Side runout with bore S_d	
		class 0,6X		class 5,6		class 4 ^①		class 0,6X	class 6	class 5	class 4	class 0,6X	class 6	class 5	class 4	class 0,6X	class 6	class 5	class 4	class 5	class 4
over	incl.	high	low	high	low	high	low	max				max				max				max	
10	18	0	-12	0	-7	0	-5	12	7	5	4	9	5	5	4	15	7	5	3	7	3
18	30	0	-12	0	-8	0	-6	12	8	6	5	9	6	5	4	18	8	5	3	8	4
30	50	0	-12	0	-10	0	-8	12	10	8	6	9	8	5	5	20	10	6	4	8	4
50	80	0	-15	0	-12	0	-9	15	12	9	7	11	9	6	5	25	10	7	4	8	5
80	120	0	-20	0	-15	0	-10	20	15	11	8	15	11	8	5	30	13	8	5	9	5
120	180	0	-25	0	-18	0	-13	25	18	14	10	19	14	9	7	35	18	11	6	10	6
180	250	0	-30	0	-22	0	-15	30	22	17	11	23	16	11	8	50	20	13	8	11	7
250	315	0	-35	—	—	—	—	35	—	—	—	26	—	—	—	60	—	—	—	—	—
315	400	0	-40	—	—	—	—	40	—	—	—	30	—	—	—	70	—	—	—	—	—
400	500	—	—	—	—	—	—	—	—	—	—	—	—	—	—	—	—	—	—	—	—
500	630	—	—	—	—	—	—	—	—	—	—	—	—	—	—	—	—	—	—	—	—
630	800	—	—	—	—	—	—	—	—	—	—	—	—	—	—	—	—	—	—	—	—
800	1,000	—	—	—	—	—	—	—	—	—	—	—	—	—	—	—	—	—	—	—	—

① The dimensional difference Δ_{ds} of bore diameter to be applied for class 4 is the same as the tolerance of dimensional difference Δ_{dmp} of average bore diameter.

Table 6.4 (2) Outer rings

Nominal outside diameter <i>D</i> mm		Dimensional tolerance of mean outside diameter within plane Δ_{Dmp}						Outside diameter variation V_{Dp}				Mean bore diameter variation V_{Dmp}				Outer ring radial runout K_{ea}				Outside surface inclination S_b ^②	
		class 0,6X		class 5,6		class 4 ^③		class 0,6X	class 6	class 5	class 4	class 0,6X	class 6	class 5	class 4	class 0,6X	class 6	class 5	class 4	class 5	class 4
over	incl.	high	low	high	low	high	low	max				max				max				max	
18	30	0	-12	0	-8	0	-6	12	8	6	5	9	6	5	4	18	9	6	4	8	4
30	50	0	-14	0	-9	0	-7	14	9	7	5	11	7	5	5	20	10	7	5	8	4
50	80	0	-16	0	-11	0	-9	16	11	8	7	12	8	6	5	25	13	8	5	8	4
80	120	0	-18	0	-13	0	-10	18	13	10	8	14	10	7	5	35	18	10	6	9	5
120	150	0	-20	0	-15	0	-11	20	15	11	8	15	11	8	6	40	20	11	7	10	5
150	180	0	-25	0	-18	0	-13	25	18	14	10	19	14	9	7	45	23	13	8	10	5
180	250	0	-30	0	-20	0	-15	30	20	15	11	23	15	10	8	50	25	15	10	11	7
250	315	0	-35	0	-25	0	-18	35	25	19	14	26	19	13	9	60	30	18	11	13	8
315	400	0	-40	0	-28	0	-20	40	28	22	15	30	21	14	10	70	35	20	13	13	10
400	500	0	-45	—	—	—	—	45	—	—	—	34	—	—	—	80	—	—	—	—	—
500	630	0	-50	—	—	—	—	50	—	—	—	38	—	—	—	100	—	—	—	—	—

② Does not apply to bearings with flange.

③ The dimensional difference Δ_{Ds} of outside diameter to be applied for class 4 is the same as the tolerance of dimensional difference Δ_{Dmp} of average outside diameter.

Unit μm

Inner ring axial runout S_{ia}	Inner ring width deviation Δ_{Bis}						Assembly width deviation of single-row tapered roller bearings $\Delta_{T's}$						Combination width deviation of double row bearings $\Delta_{B1s}, \Delta_{C1s}$		Combination width deviation of 4-row bearings $\Delta_{B2s}, \Delta_{C2s}$	
	class 0,6		class 6X		class 4,5		class 0,6		class 6X		class 4,5		class 0,6,5		class 0,6,5	
	high	low	high	low	high	low	high	low	high	low	high	low	high	low	high	low
class 4 max																
3	0	-120	0	-50	0	-200	+200	0	+100	0	+200	-200	—	—	—	—
4	0	-120	0	-50	0	-200	+200	0	+100	0	+200	-200	—	—	—	—
4	0	-120	0	-50	0	-240	+200	0	+100	0	+200	-200	+240	-240	—	—
4	0	-150	0	-50	0	-300	+200	0	+100	0	+200	-200	+300	-300	—	—
5	0	-200	0	-50	0	-400	+200	-200	+100	0	+200	-200	+400	-400	+500	-500
7	0	-250	0	-50	0	-500	+350	-250	+150	0	+350	-250	+500	-500	+600	-600
8	0	-300	0	-50	0	-600	+350	-250	+150	0	+350	-250	+600	-600	+750	-750
—	0	-350	0	-50	—	—	+350	-250	+200	0	—	—	+700	-700	+900	-900
—	0	-400	0	-50	—	—	+400	-400	+200	0	—	—	+800	-800	+1 000	-1 000
—	—	—	—	—	—	—	—	—	—	—	—	—	+900	-900	+1 200	-1 200
—	—	—	—	—	—	—	—	—	—	—	—	—	+1 000	-1 000	+1 200	-1 200
—	—	—	—	—	—	—	—	—	—	—	—	—	+1 500	-1 500	+1 500	-1 500
—	—	—	—	—	—	—	—	—	—	—	—	—	+1 500	-1 500	+1 500	-1 500

Unit μm

Outer ring axial runout S_{ea}	Outer ring width deviation Δ_{Cs}			
	class 0,6,5,4		class 6X ^①	
	sup.	inf.	sup.	inf.
class 4 max				
5			0	-100
5	Depends on tolerance of Δ_{Bs} in relation to d of same bearing		0	-100
5			0	-100
6			0	-100
7			0	-100
8			0	-100
10			0	-100
10			0	-100
13			0	-100
—			0	-100
—			0	-100

Table 6.4 (3) Effective width of outer and inner rings with roller Unit μm

Nominal bore diameter d mm	Effective width deviation of roller and inner ring assembly of tapered roller bearing Δ_{T1s}				Tapered roller bearing outer ring effective width deviation Δ_{T2s}				
	class 0		class 6X		class 0		class 6X		
	high	low	high	low	high	low	high	low	
10	18	+100	0	+50	0	+100	0	+50	0
18	30	+100	0	+50	0	+100	0	+50	0
30	50	+100	0	+50	0	+100	0	+50	0
50	80	+100	0	+50	0	+100	0	+50	0
80	120	+100	-100	+50	0	+100	-100	+50	0
120	180	+150	-150	+50	0	+200	-100	+100	0
180	250	+150	-150	+50	0	+200	-100	+100	0
250	315	+150	-150	+100	0	+200	-100	+100	0
315	400	+200	-200	+100	0	+200	-200	+100	0

① Applies to bearing where d is greater than 10 mm but is less than or equal to 400 mm.

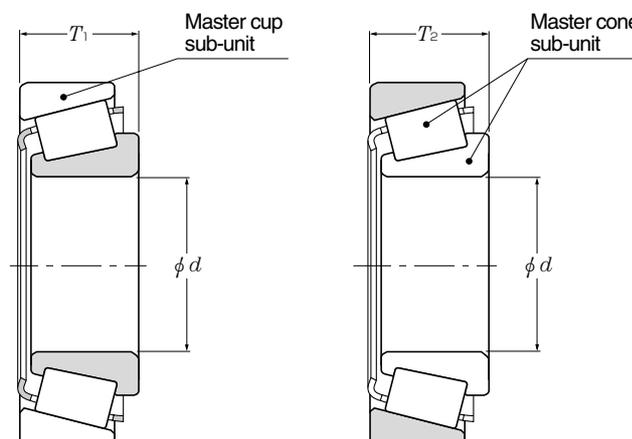

Table 6.5 Tolerance of tapered roller bearings (Inch series)

Table 6.5 (1) Inner rings

Unit μm

Nominal bore diameter d		Single bore diameter deviation Δ_{d1s}									
mm (inch)		Class 4		Class 2		Class 3		Class 0		Class 00	
over	incl.	high	low	high	low	high	low	high	low	high	low
—	76.2 (3)	+13	0	+13	0	+13	0	+13	0	+8	0
76.2 (3)	266.7 (10.5)	+25	0	+25	0	+13	0	+13	0	+8	0
266.7 (10.5)	304.8 (12)	+25	0	+25	0	+13	0	+13	0	—	—
304.8 (12)	609.6 (24)	+51	0	+51	0	+25	0	—	—	—	—
609.6 (24)	914.4 (36)	+76	0	—	—	+38	0	—	—	—	—
914.4 (36)	1 219.2 (48)	+102	0	—	—	+51	0	—	—	—	—
1 219.2 (48)	—	+127	0	—	—	+76	0	—	—	—	—

Table 6.5 (2) Outer rings

Unit μm

Nominal outside diameter D		Single outside diameter deviation Δ_{D2s}									
mm (inch)		Class 4		Class 2		Class 3		Class 0		Class 00	
over	incl.	high	low	high	low	high	low	high	low	high	low
—	266.7 (10.5)	+25	0	+25	0	+13	0	+13	0	+8	0
266.7 (10.5)	304.8 (12)	+25	0	+25	0	+13	0	+13	0	—	—
304.8 (12)	609.6 (24)	+51	0	+51	0	+25	0	—	—	—	—
609.6 (24)	914.4 (36)	+76	0	+76	0	+38	0	—	—	—	—
914.4 (36)	1 219.2 (48)	+102	0	—	—	+51	0	—	—	—	—
1 219.2 (48)	—	+127	0	—	—	+76	0	—	—	—	—

Table 6.5 (3) Single-row tapered roller bearing assembly width, combination width of 4-row bearings, effective width of inner ring with rollers, effective width of outer ring

Nominal bore diameter d		Nominal outside diameter D		Overall width deviation of assembled single row tapered roller bearing Δ_{T1s}								Overall width deviation of assembled 4-row tapered roller bearings $\Delta_{B2s}, \Delta_{C2s}$	
mm (inch)		mm (inch)		Class 4		Class 2		Class 3		Class 0,00		Class 4,2,3,0	
over	incl.	over	incl.	high	low	high	low	high	low	high	low	high	low
—	101.6 (4)	—	—	+203	0	+203	0	+203	-203	+203	-203	+1 524	-1 524
101.6 (4)	304.8 (12)	—	—	+356	-254	+203	0	+203	-203	+203	-203	+1 524	-1 524
304.8 (12)	609.6 (24)	—	508.0 (20)	+381	-381	+381	-381	+203	-203	—	—	+1 524	-1 524
304.8 (12)	609.6 (36)	508.0 (20)	—	+381	-381	+381	-381	+381	-381	—	—	+1 524	-1 524
609.6 (24)	—	—	—	+381	-381	—	—	+381	-381	—	—	+1 524	-1 524

Table 6.5 (4) Radial deflection of inner and outer rings

Unit μm

Nominal outside diameter D		Inner ring radial runout K_{ia} Outer ring radial runout K_{ea}				
mm (inch)		Class 4	Class 2	Class 3	Class 0	Class 00
over	incl.	max				
—	304.8 (14)	51	38	8	4	2
304.8 (14)	609.6 (24)	51	38	18	—	—
609.6 (24)	914.4 (36)	76	51	51	—	—
914.4 (36)	—	76	—	76	—	—

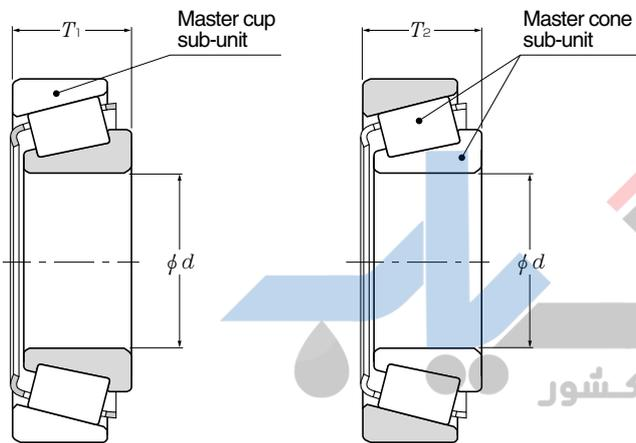

Unit μm

Effective width deviation of roller and inner ring assembly of tapered roller bearing ΔT_{1s}						Tapered roller bearing outer ring effective width deviation ΔT_{2s}					
Class 4		Class 2		Class 3		Class 4		Class 2		Class 3	
high	low	high	low	high	low	high	low	high	low	high	low
+102	0	+102	0	+102	-102	+102	0	+102	0	+102	-102
+152	-152	+102	0	+102	-102	+203	-102	+102	0	+102	-102
—	—	+178	-178 ^①	+102	-102 ^①	—	—	+203	-203 ^①	+102	-102 ^①
—	—	—	—	—	—	—	—	—	—	—	—
—	—	—	—	—	—	—	—	—	—	—	—

① To be applied for nominal bore diameters d of 406.400 mm (16 inch) or less.

Table 6.6 Tolerance of tapered roller bearings of J series (Metric series)

Table 6.6 (1) Inner rings

Nominal bore diameter <i>d</i> mm		Mean bore diameter deviation Δd_{mp}								Bore diameter variation V_{dP}				Mean bore diameter variation V_{dmp}			
over	incl.	Class K		Class N		Class C		Class B		Class K	Class N	Class C	Class B	Class K	Class N	Class C	Class B
		high	low	high	low	high	low	high	low								
10	18	0	-12	0	-12	0	-7	0	-5	12	12	4	3	9	9	5	4
18	30	0	-12	0	-12	0	-8	0	-6	12	12	4	3	9	9	5	4
30	50	0	-12	0	-12	0	-10	0	-8	12	12	4	3	9	9	5	5
50	80	0	-15	0	-15	0	-12	0	-9	15	15	5	3	11	11	5	5
80	120	0	-20	0	-20	0	-15	0	-10	20	20	5	3	15	15	5	5
120	180	0	-25	0	-25	0	-18	0	-13	25	25	5	3	19	19	5	7
180	250	0	-30	0	-30	0	-22	0	-15	30	30	6	4	23	23	5	8

Note: Please consult NTN Engineering for Class A bearings.

Table 6.6 (2) Outer rings

Nominal outside diameter <i>D</i> mm		Mean outside diameter deviation ΔD_{mp}								Outside diameter variation V_{Dp}				Mean outside diameter variation V_{Dmp}				outer ring axial runout S_{α}
over	incl.	Class K		Class N		Class C		Class B		Class K	Class N	Class C	Class B	Class K	Class N	Class C	Class B	Class B
		high	low	high	low	high	low	high	low									
18	30	0	-12	0	-12	0	-8	0	-6	12	12	4	3	9	9	5	4	3
30	50	0	-14	0	-14	0	-9	0	-7	14	14	4	3	11	11	5	5	3
50	80	0	-16	0	-16	0	-11	0	-9	16	16	4	3	12	12	6	5	4
80	120	0	-18	0	-18	0	-13	0	-10	18	18	5	3	14	14	7	5	4
120	150	0	-20	0	-20	0	-15	0	-11	20	20	5	3	15	15	8	6	4
150	180	0	-25	0	-25	0	-18	0	-13	25	25	5	3	19	19	9	7	5
180	250	0	-30	0	-30	0	-20	0	-15	30	30	6	4	23	23	10	8	6
250	315	0	-35	0	-35	0	-25	0	-18	35	35	8	5	26	26	13	9	6
315	400	0	-40	0	-40	0	-28	0	-20	40	40	10	5	30	30	14	10	6

Note: Please consult NTN Engineering for Class A bearings.

Table 6.6 (3) Effective width of inner and outer rings

Unit μm

Nominal bore diameter <i>d</i> mm		Effective width deviation of roller and inner ring assembly of tapered roller bearing Δr_{1s}								Tapered roller bearing outer ring effective width deviation Δr_{2s}							
over	incl.	Class K		Class N		Class C		Class B		Class K	Class N	Class C	Class B	Class K	Class N	Class C	Class B
		high	low	high	low	high	low	high	low								
10	80	+100	0	+50	0	+100	-100	*	*	+100	0	+50	0	+100	-100	*	*
80	120	+100	-100	+50	0	+100	-100	*	*	+100	-100	+50	0	+100	-100	*	*
120	180	+150	-150	+50	0	+100	-100	*	*	+200	-100	+100	0	+100	-150	*	*
180	250	+150	-150	+50	0	+100	-150	*	*	+200	-100	+100	0	+100	-150	*	*

Note 1: "*" mark are to be manufactured only for combined bearings.
2: Please consult NTN Engineering for Class A bearings.

Unit μm

Inner ring axial runout S_{ia}	Overall width deviation of assembled tapered roller bearing ΔT_s							
	Class K		Class N		Class C		Class B	
	sup	inf	sup	inf	sup	inf	sup	inf
	max							
3	+200	0	+100	0	+200	-200	+200	-200
4	+200	0	+100	0	+200	-200	+200	-200
4	+200	0	+100	0	+200	-200	+200	-200
4	+200	0	+100	0	+200	-200	+200	-200
5	+200	-200	+100	0	+200	-200	+200	-200
7	+350	-250	+150	0	+350	-250	+200	-250
8	+350	-250	+150	0	+350	-300	+200	-300

Table 6.6 (4) Radial runout of inner and outer rings

Unit μm

Nominal outside diameter D mm		Inner ring radial runout and Outer ring radial runout			
		K_{ia}		K_{ea}	
		Class K	Class N	Class C	Class B
over	incl.	max			
18	30	18	18	5	3
30	50	20	20	6	3
50	80	25	25	6	4
80	120	35	35	6	4
120	150	40	40	7	4
150	180	45	45	8	4
180	250	50	50	10	5
250	315	60	60	11	5
315	400	70	70	13	5

Note: Please consult NTN Engineering for Class A bearings.

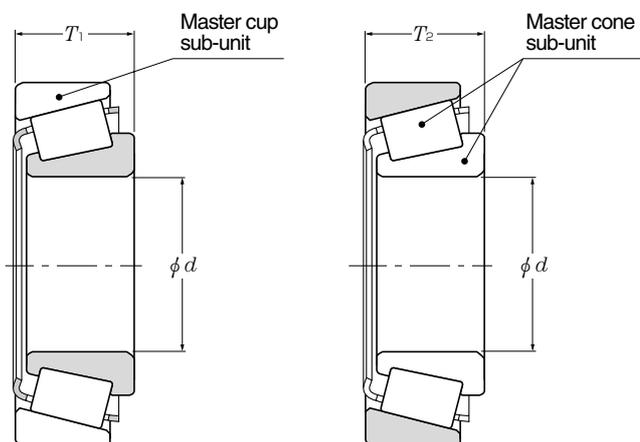

Table 6.7 Tolerance of thrust ball bearings

Table 6.7 (1) Shaft raceway washer

Unit μm

Nominal bore diameter d mm		Mean bore diameter deviation Δd_{mp}				Bore diameter variation V_{dp}		Raceway thickness variation S_i			
over	incl.	Class 0,6,5		Class 4		Class 0,6,5	Class 4	Class 0	Class 6	Class 5	Class 4
		high	low	high	low						
—	18	0	-8	0	-7	6	5	10	5	3	2
18	30	0	-10	0	-8	8	6	10	5	3	2
30	50	0	-12	0	-10	9	8	10	6	3	2
50	80	0	-15	0	-12	11	9	10	7	4	3
80	120	0	-20	0	-15	15	11	15	8	4	3
120	180	0	-25	0	-18	19	14	15	9	5	4
180	250	0	-30	0	-22	23	17	20	10	5	4
250	315	0	-35	0	-25	26	19	25	13	7	5
315	400	0	-40	0	-30	30	23	30	15	7	5
400	500	0	-45	0	-35	34	26	30	18	9	6
500	630	0	-50	0	-40	38	30	35	21	11	7

Table 6.7 (2) Housing raceway washer

Unit μm

Nominal outside diameter D mm		Mean outside diameter deviation ΔD_{mp}				Outside diameter variation V_{Dp}		Raceway thickness variation S_e			
over	incl.	Class 0,6,5		Class 4		Class 0,6,5	Class 4	Class 0	Class 6	Class 5	Class 4
		high	low	high	low						
10	18	0	-11	0	-7	8	5	According to the tolerance of S_1 against "d" of the same bearings			
18	30	0	-13	0	-8	10	6				
30	50	0	-16	0	-9	12	7				
50	80	0	-19	0	-11	14	8				
80	120	0	-22	0	-13	17	10				
120	180	0	-25	0	-15	19	11				
180	250	0	-30	0	-20	23	15				
250	315	0	-35	0	-25	26	19				
315	400	0	-40	0	-28	30	21				
400	500	0	-45	0	-33	34	25				
500	630	0	-50	0	-38	38	29				
630	800	0	-75	0	-45	55	34				

Table 6.7 (3) Bearing height

Unit μm

Nominal bore diameter d mm		Single direction Bearing height deviation ΔT_s	
over	incl.	high	low
—	30	0	-75
30	50	0	-100
50	80	0	-125
80	120	0	-150
120	180	0	-175
180	250	0	-200
250	315	0	-225
315	400	0	-300
400	500	0	-350
500	630	0	-400

① This standard is applied for flat back face bearing of class 0.

Table 6.8 Tolerance of spherical thrust roller bearing

Table 6.8 (1) Shaft raceway washer

Unit μm

Nominal bore diameter d mm		Mean bore diameter deviation Δd_{imp}		Bore diameter variation V_{dp}	Side runout with bore S_d	Bearing height deviation Δr_s	
over	incl.	high	low	max	max	high	low
50	80	0	-15	11	25	+150	-150
80	120	0	-20	15	25	+200	-200
120	180	0	-25	19	30	+250	-250
180	250	0	-30	23	30	+300	-300
250	315	0	-35	26	35	+350	-350
315	400	0	-40	30	40	+400	-400
400	500	0	-45	34	45	+450	-450

Table 6.8 (2) Housing raceway washer

Unit μm

Nominal outside diameter D mm		Single plane mean outside diameter deviation ΔD_{mp}	
over	incl.	high	low
120	180	0	-25
180	250	0	-30
250	315	0	-35
315	400	0	-40
400	500	0	-45
500	630	0	-50
630	800	0	-75
800	1,000	0	-100



6.2 Chamfer measurements and tolerance or allowable values of tapered bore

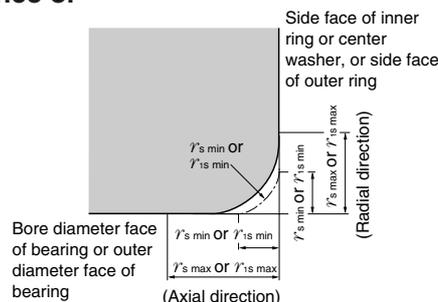

Table 6.9 Allowable critical-value of bearing chamfer

Table 6.9 (1) Radial bearing (Except tapered roller bearing)

r's min ^① or r's min	Nominal bore diameter d		r's max OR r's max	
	over	incl.	Radial direction	Axial direction
0.05	—	—	0.1	0.2
0.08	—	—	0.16	0.3
0.1	—	—	0.2	0.4
0.15	—	—	0.3	0.6
0.2	—	—	0.5	0.8
0.3	—	40	0.6	1
	40	—	0.8	1
0.6	—	40	1	2
	40	—	1.3	2
1	—	50	1.5	3
	50	—	1.9	3
1.1	—	120	2	3.5
	120	—	2.5	4
1.5	—	120	2.3	4
	120	—	3	5
2	—	80	3	4.5
	80	220	3.5	5
	220	—	3.8	6
2.1	—	280	4	6.5
	280	—	4.5	7
2.5	—	100	3.8	6
	100	280	4.5	6
	280	—	5	7
3	—	280	5	8
	280	—	5.5	8
4	—	—	6.5	9
5	—	—	8	10
6	—	—	10	13
7.5	—	—	12.5	17
9.5	—	—	15	19
12	—	—	18	24
15	—	—	21	30
19	—	—	25	38

① These are the allowable minimum dimensions of the chamfer dimension "r" or "r1" and are described in the dimensional table.

Table 6.9 (2) Tapered roller bearings of metric series

r's min ^② or r's min	Nominal bore diameter of bearing "d" or nominal outside diameter "D"		r's max OR r's max	
	over	incl.	Radial direction	Axial direction
0.3	—	40	0.7	1.4
	40	—	0.9	1.6
0.6	—	40	1.1	1.7
	40	—	1.3	2
1	—	50	1.6	2.5
	50	—	1.9	3
	—	120	2.3	3
1.5	120	250	2.8	3.5
	250	—	3.5	4
	—	120	2.8	4
2	120	250	3.5	4.5
	250	—	4	5
	—	120	3.5	5
2.5	120	250	4	5.5
	250	—	4.5	6
	—	120	4	5.5
3	120	250	4.5	6.5
	250	400	5	7
	400	—	5.5	7.5
	—	120	5	7
4	120	250	5.5	7.5
	250	400	6	8
	400	—	6.5	8.5
5	—	180	6.5	8
	180	—	7.5	9
6	—	180	7.5	10
	180	—	9	11

② These are the allowable minimum dimensions of the chamfer dimension "r" or "r1" and are described in the dimensional table.

③ Inner rings shall be in accordance with the division of "d" and outer rings with that of "D".

Note: This standard will be applied to the bearings whose dimensional series (refer to the dimensional table) are specified in the standard of ISO 355 or JIS B 1512. For further information concerning bearings outside of these standards or tapered roller bearings using US customary unit, please contact NTN Engineering.

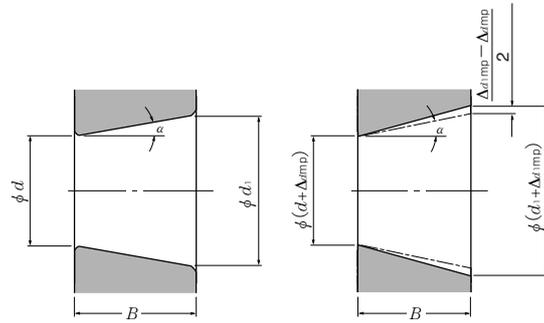

Theoretical tapered bore

Tapered bore having dimensional difference of the average bore diameter within the flat surface

Table 6.9 (3) Thrust bearings

Unit mm

r_1 's min OR r_2 's min ^①	r_1 's max OR r_2 's max Radial and axial direction
0.05	0.1
0.08	0.16
0.1	0.2
0.15	0.3
0.2	0.5
0.3	0.8
0.6	1.5
1	2.2
1.1	2.7
1.5	3.5
2	4
2.1	4.5
3	5.5
4	6.5
5	8
6	10
7.5	12.5
9.5	15
12	18
15	21
19	25

① These are the allowable minimum dimensions of the chamfer dimension " r_1 " or " r_2 " and are described in the dimensional table.

Table 6.10 (1) Tolerance of and tolerance values for tapered bore of radial bearings
Standard taper ratio 1:12 tapered hole (class 0) Unit μ m

d mm		Δd_{1mp}		$\Delta d_{1mp} - \Delta d_{1mp}$		V_{dp} ^{① ②}
over	incl.	high	low	high	low	max
10	18	+22	0	+15	0	9
18	30	+27	0	+18	0	11
		+33	0	+21	0	13
30	50	+39	0	+25	0	16
50	80	+46	0	+30	0	19
80	120	+54	0	+35	0	22
120	180	+63	0	+40	0	40
180	250	+72	0	+46	0	46
250	315	+81	0	+52	0	52
315	400	+89	0	+57	0	57
400	500	+97	0	+63	0	63
500	630	+110	0	+70	0	70
630	800	+125	0	+80	0	—
800	1,000	+140	0	+90	0	—
1,000	1,250	+165	0	+105	0	—
1,250	1,600	+195	0	+125	0	—

Table 6.10 (2) Tolerance of and tolerance values for tapered bore of radial bearings
Standard taper ratio 1:30 tapered bore (class 0) Units μ m

d mm		Δd_{1mp}		$\Delta d_{1mp} - \Delta d_{1mp}$		V_{dp} ^{① ②}
over	incl.	high	low	high	low	max
50	80	+15	0	+30	0	19
80	120	+20	0	+35	0	22
120	180	+25	0	+40	0	40
180	250	+30	0	+46	0	46
250	315	+35	0	+52	0	52
315	400	+40	0	+57	0	57
400	500	+45	0	+63	0	63
500	630	+50	0	+70	0	70

① Applies to all radial flat planes of inner ring tapered bore.

② Does not apply to diameter series 7 and 8.

Note: Quantifiers

For a standard taper ratio of 1:12 $d_1 = d + \frac{1}{12} B$

For a standard taper ratio of 1:30 $d_1 = d + \frac{1}{30} B$

Δd_{1mp} : Dimensional difference of the average bore diameter within the flat surface at the theoretical small end of the tapered bore.

Δd_{1mp} : Dimensional difference of the average bore diameter within the flat surface at the theoretical large end of the tapered bore.

V_{dp} : Unevenness of the bore diameter with the flat surface

B : Nominal width of inner ring

α : Half of the tapered bore's nominal taper angle

For a standard taper ratio of 1:12 $\alpha = 2^\circ 23' 9.4''$

For a standard taper ratio of 1:30 $\alpha = 0^\circ 57' 7.4''$

6.3 Bearing tolerance measurement methods

For reference, measurement methods for rolling bearing tolerances are in JIS B 1515.

Table 6.11 shows some of the major methods of measuring rotation tolerances.

Table 6.11 Rotation tolerance measurement methods

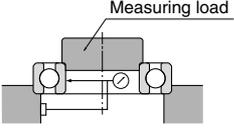
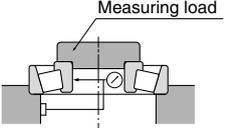
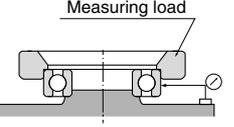
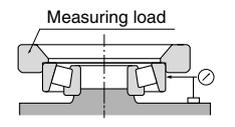
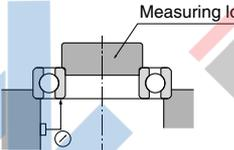
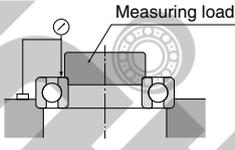
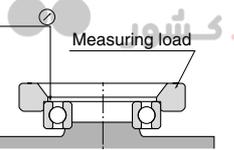
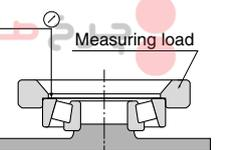
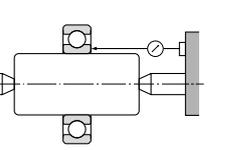
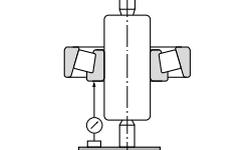
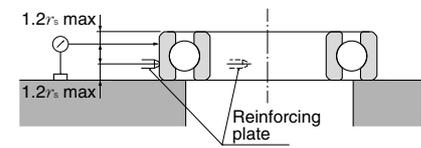
Characteristic tolerance	Measurement method	
Inner ring radial runout (K_{ia})		 <p>Radial runout of the inner ring is the difference between the maximum and minimum reading of the measuring device when the inner ring is turned one revolution.</p>
Outer ring radial runout (K_{ea})		 <p>Radial runout of the outer ring is the difference between the maximum and minimum reading of the measuring device when the outer ring is turned one revolution.</p>
Inner ring axial runout (S_{ia})		 <p>Axial runout of the inner ring is the difference between the maximum and minimum reading of the measuring device when the inner ring is turned one revolution.</p>
Outer ring axial runout (S_{ea})		 <p>Axial runout of the outer ring is the difference between the maximum and minimum reading of the measuring device when the outer ring is turned one revolution.</p>
Inner ring side runout with bore (S_a)		 <p>Inner ring side runout with bore is the difference between the maximum and minimum reading of the measuring device when the inner ring is turned one revolution together with the tapered mandrel.</p>
Outer ring outside surface inclination (S_b)	 <p>Outer ring outside surface inclination is the difference between the maximum and minimum reading of the measuring device when the outside ring is turned one revolution along the reinforcing plate.</p>	

7. Bearing Fits

7.1 Fitting

For rolling bearings, inner and outer rings are fixed on the shaft or in the housing so that relative movement does not occur between fitting surfaces during operation or under load. This relative movement between the fitting surfaces of the bearing and the shaft or housing can occur in a radial direction, an axial direction, or in the direction of rotation. Types of fitting include tight, transition and loose fitting, which may be selected depending on whether or not there is interference.

The most effective way to fix the fitting surfaces between a bearing's raceway and shaft or housing is to apply a **"tight fit."** The advantage of this tight fit for thin walled bearings is that it provides uniform load support over the entire ring circumference without any loss of load carrying capacity. However, with a tight fit, ease of installation and disassembly is lost; and when using a non-separable bearing as the floating-side bearing, axial displacement is not possible. For this reason, a tight fit cannot be recommended in all cases.

7.2 The necessity of a proper fit

In some cases, improper fit may lead to damage and shorten bearing life, therefore it is necessary to make a careful investigation in selecting a proper fit. Some of the bearing failure caused by improper fit are listed below.

- Raceway cracking, early flaking and displacement of raceway
- Raceway and shaft or housing abrasion caused by creeping and fretting corrosion
- Seizing caused by negative internal clearances

- Increased noise and deteriorated rotational accuracy due to raceway groove deformation

Please refer to insert pages A-96 ~ A-99 for information concerning diagnosis of these conditions.

7.3 Fit selection

Selection of a proper fit is dependent upon thorough analysis of bearing operating conditions, including consideration of:

- Shaft and housing material, wall thickness, finished surface accuracy, etc.
- Machinery operating conditions (nature and magnitude of load, rotational speed, temperature, etc.)

7.3.1 "Tight fit" or "Loose fit"

(1) For raceways under rotating loads, a tight fit is necessary. (Refer to **Table 7.1** "Raceways under rotating loads" refers to raceways receiving loads rotating relative to their radial direction. For raceways under static loads, on the other hand, a loose fit is sufficient.

(Example) Rotating inner ring load = the direction of the radial load on the inner ring is rotating relatively

(2) For non-separable bearings, such as deep groove ball bearings, it is generally recommended that either the inner ring or outer ring be given a loose fit.

Table 7.1 Radial load and bearing fit

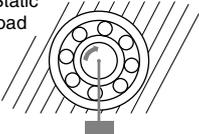
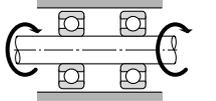
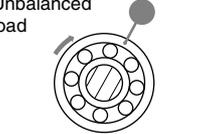
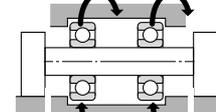
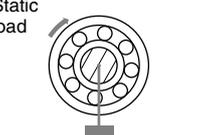
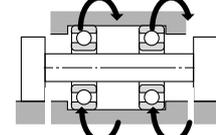
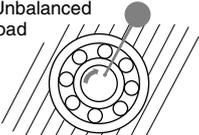
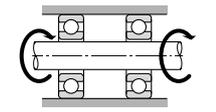
Illustration	Bearing rotation	Ring load	Fit
 <p>Static load</p>	 <p>Inner ring: Rotating Outer ring: Stationary</p>	Rotating inner ring load	Inner ring : Tight fit
 <p>Unbalanced load</p>	 <p>Inner ring: Stationary Outer ring: Rotating</p>	Static outer ring load	Outer ring : Loose fit
 <p>Static load</p>	 <p>Inner ring: Stationary Outer ring: Rotating</p>	Static inner ring load	Inner ring : Loose fit
 <p>Unbalanced load</p>	 <p>Inner ring: Rotating Outer ring: Stationary</p>	Rotating outer ring load	Outer ring : Tight fit

- (4) A particular type of fit is recommended for SL type cylindrical roller bearings.

Table 7.2 General standards for radial bearing fits (JIS Class 0, 6X, 6)

Table 7.2 (1) Tolerance class of shafts commonly used for radial bearings (classes 0, 6X and 6)

Conditions	Ball bearings		Cylindrical roller bearing Tapered roller bearing		Spherical roller bearing		Shaft tolerance class	Remarks	
	Shaft diameter (mm)								
	Over	Under	Over	Under	Over	Under			
Cylindrical bore bearing (Classes 0, 6X and 6)									
Inner ring rotational load or load of undetermined direction	Light load ^① or fluctuating load	— 18 100 —	18 100 200 —	— 40 140 —	— 40 140 200 —	— — — —	h5 js6 k6 m6	When greater accuracy is required js5, k5, and m5 may be substituted for js6, k6, and m6.	
	Ordinary load ^①	— 18 100 140 200 — —	18 100 140 200 280 — —	— 40 100 100 140 200 —	— 40 100 140 200 400 —	— — 40 65 100 140 280 500	js5 k5 m5 m6 n6 p6 r6	Alteration of inner clearances to accommodate fit is not a consideration with single-row angular contact bearings and tapered roller bearings. Therefore, k5 and m5 may be substituted for k6 and m6.	
	Heavy load ^① or impact load	— — —	— — —	50 140 200	140 200 —	50 100 140	100 140 200	n6 p6 r6	Use bearings with larger internal clearances than CN clearance bearings.
Inner ring static load	Inner ring must move easily over shaft	Overall shaft diameter						g6	When greater accuracy is required use g5. For large bearings, f6 will suffice for to facilitate movement.
	Inner does not have to move easily over shaft	Overall shaft diameter						h6	When greater accuracy is required use h5.
Center axial load	Overall shaft diameter						js6	Generally, shaft and inner rings are not fixed using interference.	
Tapered bore bearing (class 0) (with adapter or withdrawal sleeve)									
Overall load	Overall shaft diameter						h9/IT5 ^②	h10/IT7 ^② will suffice for power transmitting shafts.	

Table 7.2 (2) Fit with shaft (fits for tapered bore bearings (Class 0) with adapter assembly/withdrawal sleeve)

All loads	All bearing types	All shaft diameters	Tolerance class	h9 / IT5 ^②	General applications
				h10/ IT7 ^②	Transmission shafts, etc.

① Standards for light loads, normal loads, and heavy loads

- Light loads: equivalent radial load $\leq 0.06 C_r$
- Normal loads: $0.06 C_r < \text{equivalent radial load} \leq 0.12 C_r$
- Heavy loads: $0.12 C_r < \text{equivalent radial load}$

② IT5 and IT7 show shaft roundness tolerances, cylindricity tolerances, and related values.

Note: All values and fits listed in the above tables are for solid steel shafts.

Table 7.2 (3) Tolerance class of housing bore commonly used for radial bearings (classes 0, 6X and 6)

Housing	Conditions			Toleration class of housing bore	Remarks
	Types of load	Outer ring axial direction movement ^②			
Single housing or divided housing	Outer ring static load	All types of loads	Able to move.	H7	G7 will suffice for large bearings or bearings with large temperature differential between the outer ring and housing.
		Light load ^① or ordinary load ^①	Able to move.	H8	—
		Shaft and inner ring become hot.	Able to move easily.	G7	F7 will suffice for large bearings or bearings with large temperature differential between the outer ring and housing.
Single housing	Indeterminate load	Requires precision rotation with light or ordinary loads.	As a rule, cannot move.	K6	Primarily applies to roller bearings.
			Able to move.	JS6	Primarily applies to ball bearings.
		Requires quiet operation.	Able to move.	H6	—
	Indeterminate load	Light or ordinary load	Able to move.	JS7	If precision is required, JS6 and K6 are used in place of JS7 and K7.
		Ordinary load or heavy load ^①	As a rule, cannot move.	K7	
		Large impact load	Cannot move.	M7	
	Outer ring rotational load	Light or fluctuating load	Cannot move.	M7	—
		Ordinary or heavy load	Cannot move.	N7	Primarily applies to ball bearings.
		Heavy load or large impact load with thin housing	Cannot move.	P7	Primarily applies to roller bearings.

① Standards for light loads, normal loads, and heavy loads

- Light loads: equivalent radial load $\leq 0.06 C_r$
- Normal loads: $0.06 C_r < \text{equivalent radial load} \leq 0.12 C_r$
- Heavy loads: $0.12 C_r < \text{equivalent radial load}$

② Indicates whether or not outer ring axial displacement is possible with non-separable type bearings.

Note 1: All values and fits listed in the above tables are for cast iron or steel housings.

2: If only center axial load is applied to the bearing, select a tolerance class that provides clearance for the outer ring in the axial direction.

Table 7.3 Standard fits for thrust bearings (JIS Class 0 and 6)

Table 7.3 (1) Shaft fits

Bearing type	Load conditions	Fit	Shaft diameter mm over incl.	Tolerance class
All thrust bearings	Centered axial load only	Transition fit	All sizes	js6 or h6
Spherical roller thrust bearings	Combined load Inner ring static load or Inner ring rotating load Indeterminate load	Transition fit	All sizes	js6
		Tight fit	— ~ 200 200 ~ 400 400 ~	k6 or js6 m6 or k6 n6 or m6

Table 7.3 (2) Housing fits

Bearing type	Load conditions	Fit	Tolerance class	Remarks
All thrust bearings	Centered axial load only	Loose fit	Select a tolerance class that will provide clearance between outer ring and housing.	
			H8	Greater accuracy required with thrust ball bearings
Spherical roller thrust bearings	Combined load Outer ring static load Indeterminate load or outer ring rotating load	Transition fit	H7	—
			M7	For relatively large radial loads

Note: All values and fits listed in the above tables are for cast iron or steel housings.

Table 7.4 Fits for electric motor bearings

Bearing type	Shaft fits		Housing fits	
	Shaft diameter mm over incl.	Tolerance class	Housing bore diameter	Tolerance class
Deep groove ball bearings	~ 18 18 ~ 100 100 ~ 160	j5 k5 m5	All sizes	H6 or J6
Cylindrical roller bearings	~ 40 40 ~ 160 160 ~ 200	k5 m5 n6	All sizes	H6 or J6

Table 7.5 Numeric value table of fitting for radial bearing of 0 class

Table 7.5 (1) Fitting against shaft

Nominal bore diameter of bearing d mm over incl.	Mean bore diameter deviation ^① Δd_{mp} high low		g5		g6		h5		h6		j5		js5		j6	
			bearing	shaft	bearing	shaft	bearing	shaft	bearing	shaft	bearing	shaft	bearing	shaft	bearing	shaft
3 6	0	-8	4T~ 9L	4T~ 12L	8T~ 5L	8T~ 8L	11T~ 2L	10.5T~ 2.5L	14T~ 2L							
6 10	0	-8	3T~ 11L	3T~ 14L	8T~ 6L	8T~ 9L	12T~ 2L	11T ~ 3L	15T~ 2L							
10 18	0	-8	2T~ 14L	2T~ 17L	8T~ 8L	8T~ 11L	13T~ 3L	12T ~ 4L	16T~ 3L							
18 30	0	-10	3T~ 16L	3T~ 20L	10T~ 9L	10T~ 13L	15T~ 4L	14.5T~ 4.5L	19T~ 4L							
30 50	0	-12	3T~ 20L	3T~ 25L	12T~ 11L	12T~ 16L	18T~ 5L	17.5T~ 5.5L	23T~ 5L							
50 80	0	-15	5T~ 23L	5T~ 29L	15T~ 13L	15T~ 19L	21T~ 7L	21.5T~ 6.5L	27T~ 7L							
80 120	0	-20	8T~ 27L	8T~ 34L	20T~ 15L	20T~ 22L	26T~ 9L	27.5T~ 7.5L	33T~ 9L							
120 140 140 160 160 180	0	-25	11T~ 32L	11T~ 39L	25T~ 18L	25T~ 25L	32T~ 11L	34T ~ 9L	39T~ 11L							
180 200 200 225 225 250	0	-30	15T~ 35L	15T~ 44L	30T~ 20L	30T~ 29L	37T~ 13L	40T ~ 10L	46T~ 13L							
250 280 280 315	0	-35	18T~ 40L	18T~ 49L	35T~ 23L	35T~ 32L	42T~ 16L	46.5T~ 11.5L	51T~ 16L							
315 355 355 400	0	-40	22T~ 43L	22T~ 54L	40T~ 25L	40T~ 36L	47T~ 18L	52.5T~ 12.5L	58T~ 18L							
400 450 450 500	0	-45	25T~ 47L	25T~ 60L	45T~ 27L	45T~ 40L	52T~ 20L	58.5T~ 13.5L	65T~ 20L							

① Above table is not applicable to tapered roller bearings whose bore diameter d is 30mm or less.

Table 7.5 (2) Fitting against housing

Nominal outside diameter of bearing D mm over incl.	Mean outside diameter deviation ^② ΔD_{mp} high low		G7		H6		H7		J6		J7		Js7		K6	
			housing	bearing	housing	bearing	housing	bearing	housing	bearing	housing	bearing	housing	bearing	housing	bearing
6 10	0	-8	5L~ 28L	0~ 17L	0~ 23L	4T~ 13L	7T~ 16L	7.5T~ 15.5L	7T~ 10L							
10 18	0	-8	6L~ 32L	0~ 19L	0~ 26L	5T~ 14L	8T~ 18L	9T ~ 17L	9T~ 10L							
18 30	0	-9	7L~ 37L	0~ 22L	0~ 30L	5T~ 17L	9T~ 21L	10.5T~ 19.5L	11T~ 11L							
30 50	0	-11	9L~ 45L	0~ 27L	0~ 36L	6T~ 21L	11T~ 25L	12.5T~ 23.5L	13T~ 14L							
50 80	0	-13	10L~ 53L	0~ 32L	0~ 43L	6T~ 26L	12T~ 31L	15T ~ 28L	15T~ 17L							
80 120	0	-15	12L~ 62L	0~ 37L	0~ 50L	6T~ 31L	13T~ 37L	17.5T~ 32.5L	18T~ 19L							
120 150	0	-18	14L~ 72L	0~ 43L	0~ 58L	7T~ 36L	14T~ 44L	20T ~ 38L	21T~ 22L							
150 180	0	-25	14L~ 79L	0~ 50L	0~ 65L	7T~ 43L	14T~ 51L	20T ~ 45L	21T~ 29L							
180 250	0	-30	15L~ 91L	0~ 59L	0~ 76L	7T~ 52L	16T~ 60L	23T ~ 53L	24T~ 35L							
250 315	0	-35	17L~ 104L	0~ 67L	0~ 87L	7T~ 60L	16T~ 71L	26T ~ 61L	27T~ 40L							
315 400	0	-40	18L~ 115L	0~ 76L	0~ 97L	7T~ 69L	18T~ 79L	28.5T~ 68.5L	29T~ 47L							
400 500	0	-45	20L~ 128L	0~ 85L	0~ 108L	7T~ 78L	20T~ 88L	31.5T~ 76.5L	32T~ 53L							

② Above table is not applicable to tapered roller bearings whose outside diameter D is 150mm or less.

Note: Fitting symbol "L" indicates clearance and "T" indicates interference.

Unit μm

js6		k5		k6		m5		m6		n6		p6		r6		Nominal bore diameter of bearing <i>d</i> mm over incl.
bearing	shaft	bearing	shaft	bearing	shaft	bearing	shaft	bearing	shaft	bearing	shaft	bearing	shaft	bearing	shaft	
12T ~ 4L		14T~1T		17T~1T		17T~ 4T		20T~ 4T		24T~ 8T		28T~12T		— —		3 6
12.5T~ 4.5L		15T~1T		18T~1T		20T~ 6T		23T~ 6T		27T~10T		32T~15T		— —		6 10
13.5T~ 5.5L		17T~1T		20T~1T		23T~ 7T		26T~ 7T		31T~12T		37T~18T		— —		10 18
16.5T~ 6.5L		21T~2T		25T~2T		27T~ 8T		31T~ 8T		38T~15T		45T~22T		— —		18 30
20T ~ 8L		25T~2T		30T~2T		32T~ 9T		37T~ 9T		45T~17T		54T~26T		— —		30 50
24.5T~ 9.5L		30T~2T		36T~2T		39T~11T		45T~11T		54T~20T		66T~32T		— —		50 80
31T ~11L		38T~3T		45T~2T		48T~13T		55T~13T		65T~23T		79T~37T		— —		80 120
37.5T~12.5L		46T~3T		53T~3T		58T~15T		65T~15T		77T~27T		93T~43T		113T~ 63T 115T~ 65T 118T~ 68T		120 140 140 160 160 180
44.5T~14.5L		54T~4T		63T~4T		67T~17T		76T~17T		90T~31T		109T~50T		136T~ 77T 139T~ 80T 143T~ 84T		180 200 200 225 225 250
51T ~16L		62T~4T		71T~4T		78T~20T		87T~20T		101T~34T		123T~56T		161T~ 94T 165T~ 98T		250 280 280 315
58T ~18L		69T~4T		80T~4T		86T~21T		97T~21T		113T~37T		138T~62T		184T~108T 190T~114T		315 355 355 400
65T ~20L		77T~5T		90T~4T		95T~23T		108T~23T		125T~40T		153T~68T		211T~126T 217T~132T		400 450 450 500

Unit μm

K7		M7		N7		P7		Nominal outside diameter of bearing <i>D</i> mm over incl.
housing	bearing	housing	bearing	housing	bearing	housing	bearing	
10T~13L		15T~ 8L		19T~ 4L		24T~ 1T		6 10
12T~14L		18T~ 8L		23T~ 3L		29T~ 3T		10 18
15T~15L		21T~ 9L		28T~ 2L		35T~ 5T		18 30
18T~18L		25T~11L		33T~ 3L		42T~ 6T		30 50
21T~22L		30T~13L		39T~ 4L		51T~ 8T		50 80
25T~25L		35T~15L		45T~ 5L		59T~ 9T		80 120
28T~30L		40T~18L		52T~ 6L		68T~10T		120 150
28T~37L		40T~25L		52T~13L		68T~ 3T		150 180
33T~43L		46T~30L		60T~16L		79T~ 3T		180 250
36T~51L		52T~35L		66T~21L		88T~ 1T		250 315
40T~57L		57T~40L		73T~24L		98T~ 1T		315 400
45T~63L		63T~45L		80T~28L		108T~ 0		400 500

Table 7.6 General fitting standards for tapered roller bearings using US customary unit (ANSI class 4)

Table 7.6 (1) Fit with shaft

Unit μm

Operating conditions		Nominal bearing bore diameter d mm		Bore diameter tolerance Δ_{ds}		Shaft diameter tolerance		Fitting ^①		Remark
		over	incl.	high	low	high	low	max	min	
Inner ring rotational load	Ordinary load	~ 76.2		+13	0	+ 38	+ 25	38T	~ 12T	Applicable when slight impact load is applied as well.
		76.2 ~ 304.8		+25	0	+ 64	+ 38	64T	~ 13T	
		304.8 ~ 609.6		+51	0	+127	+ 76	127T	~ 25T	
		609.6 ~ 914.4		+76	0	+190	+114	190T	~ 38T	
Inner ring rotational load	Heavy load Impact load	~ 76.2		+13	0	+ 64	+ 38	38T	~ 12T	0.5 μm mean interference per 1 mm of inner ring bore diameter. Minimum interference is 25 μm . Tolerance for the shaft is adjusted to match tolerance of bearing bore diameter.
		76.2 ~ 304.8		+25	0					
		304.8 ~ 609.6		+51	0					
		609.6 ~ 914.4		+76	0					
Outer ring rotational load	Inner ring does not have to move easily over shaft with ordinary load.	~ 76.2		+13	0	+ 13	0	13T	~ 13L	Not applicable when impact load is applied.
		76.2 ~ 304.8		+25	0	+ 25	0	25T	~ 25L	
		304.8 ~ 609.6		+51	0	+ 51	0	51T	~ 51L	
		609.6 ~ 914.4		+76	0	+ 76	0	76T	~ 76L	
Outer ring rotational load	Inner ring must move easily over shaft with ordinary load.	~ 76.2		+13	0	0	- 13	0	~ 13L	
		76.2 ~ 304.8		+25	0	0	- 25	0	~ 50L	
		304.8 ~ 609.6		+51	0	0	- 51	0	~ 102L	
		609.6 ~ 914.4		+76	0	0	- 76	0	~ 152L	

Table 7.6 (2) Fit with housing

Unit μm

Operating conditions		Nominal bearing outer diameter D mm		Outer diameter tolerance Δ_{Ds}		Housing bore diameter tolerance		Fitting ^①		Types of fit
		over	incl.	high	low	high	low	max	min	
Inner ring rotational load	When used on floating- or fixed side	~ 76.2		+25	0	+ 76	+ 51	26L	~ 76L	loose fit
		76.2 ~ 127.0		+25	0	+ 76	+ 51	26L	~ 76L	
		127.0 ~ 304.8		+25	0	+ 76	+ 51	26L	~ 76L	
		304.8 ~ 609.6		+51	0	+152	+102	51L	~ 152L	
Inner ring rotational load	When outer ring is adjusted in axial direction	~ 76.2		+25	0	+ 25	0	25T	~ 25L	transition fit
		76.2 ~ 127.0		+25	0	+ 25	0	25T	~ 25L	
		127.0 ~ 304.8		+25	0	+ 51	0	25T	~ 51L	
		304.8 ~ 609.6		+51	0	+ 76	+ 26	25T	~ 76L	
Inner ring rotational load	When outer ring is not adjusted in axial direction	~ 76.2		+25	0	- 13	- 38	63T	~ 13T	tight fit
		76.2 ~ 127.0		+25	0	- 25	- 51	76T	~ 25T	
		127.0 ~ 304.8		+25	0	- 25	- 51	76T	~ 25T	
		304.8 ~ 609.6		+51	0	- 25	- 76	127T	~ 25T	
Outer ring rotational load	When outer ring is not adjusted in axial direction	~ 76.2		+25	0	- 13	- 38	63T	~ 13T	
		76.2 ~ 127.0		+25	0	- 25	- 51	76T	~ 25T	
		127.0 ~ 304.8		+25	0	- 25	- 51	76T	~ 25T	
		304.8 ~ 609.6		+51	0	- 25	- 76	127T	~ 25T	
Outer ring rotational load		~ 76.2		+25	0	- 25	-102	178T	~ 25T	
		76.2 ~ 127.0		+25	0	- 25	-102	178T	~ 25T	
		127.0 ~ 304.8		+25	0	- 25	-102	178T	~ 25T	
		304.8 ~ 609.6		+51	0	- 25	-102	178T	~ 25T	

① Fitting symbol "L" indicates clearance and "T" indicates interference.

Table 7.7 General fitting standards for tapered roller bearings using US customary unit (ANSI classes 3 and 0)

Table 7. (1) Fit with shaft

Unit μm

Operating conditions		Nominal bearing bore diameter d mm		Bore diameter tolerance Δ_{ds}		Shaft diameter tolerance		Fitting ①	
		over	incl.	high	low	high	low	max	min
Inner ring rotational load	Precision machine tool spindles	~ 304.8		+13	0	+ 30	+ 18	30T	~ 5T
		304.8	~ 609.6	+25	0	+ 64	+ 38	64T	~ 13T
		609.6	~ 914.4	+38	0	+102	+ 64	102T	~ 26T
Outer ring rotational load	Precision machine tool spindles	~ 304.8		+13	0	+ 13	0	30T	~ 5T
		304.8	~ 609.6	+25	0	+ 25	0	64T	~ 13T
		609.6	~ 914.4	+38	0	+102	0	102T	~ 26T
		Minimum interference is 0.25 μm per 1 mm of inner ring bore diameter.							

Note: For class 0, bearing bore diameter d applies to 241.3 mm or less.

Table 7.7 (2) Fit with housing

Unit μm

Operating conditions		Nominal bearing outer diameter D mm		Outer diameter tolerance Δ_{Ds}		Housing bore diameter tolerance		Fitting ①		Type of fit
		over	incl.	high	low	high	low	max	min	
Inner ring rotational load	When used for floating-side	~ 152.4		+13	0	+38	+ 25	12L	~ 38L	loose fit
		152.4	~ 304.8	+13	0	+ 38	+ 25	12L	~ 38L	
		304.8	~ 609.6	+25	0	+ 64	+ 38	13L	~ 64L	
		609.6	~ 914.4	+38	0	+ 89	+ 51	13L	~ 89L	
	When used for fixed side	~ 152.4		+13	0	+ 25	+ 13	0	~ 25L	loose fit
		152.4	~ 304.8	+13	0	+ 25	+ 13	0	~ 25L	
		304.8	~ 609.6	+25	0	+ 51	+ 25	0	~ 51L	
		609.6	~ 914.4	+38	0	+ 76	+ 38	0	~ 76L	
When outer ring is adjusted in axial direction	~ 152.4		+13	0	+ 13	0	13T	~ 13L	transition fit	
	152.4	~ 304.8	+13	0	+ 13	0	13T	~ 13L		
	304.8	~ 609.6	+13	0	+ 25	0	25T	~ 25L		
	609.6	~ 914.4	+38	0	+ 38	0	38T	~ 38L		
When outer ring is not adjusted in axial direction	~ 152.4		+13	0	0	- 13	26T	~ 0	tight fit	
	152.4	~ 304.8	+13	0	0	- 25	38T	~ 0		
	304.8	~ 609.6	+25	0	0	- 25	50T	~ 0		
	609.6	~ 914.4	+38	0	0	- 38	76T	~ 0		
Outer ring rotational load	Ordinary load When outer ring is not adjusted in axial direction	~ 152.4		+13	0	- 13	- 25	38T	~ 13T	tight fit
		152.4	~ 304.8	+13	0	- 13	- 38	51T	~ 13T	
		304.8	~ 609.6	+25	0	- 13	- 38	63T	~ 13T	
		609.6	~ 914.4	+38	0	- 13	- 51	89T	~ 13T	

① Fitting symbol "L" indicates clearance and "T" indicates interference.

Note: For class 0, bearing outer diameter D applies to 304.8 mm or less.

8. Bearing Internal Clearance and Preload

8.1 Bearing internal clearance

Bearing internal clearance is the amount of internal free movement before mounting.

As shown in **Fig. 8.1**, when either the inner ring or the outer ring is fixed and the other ring is free to move, displacement can take place in either an axial or radial direction. This amount of displacement (radially or axially) is termed the internal clearance and, depending on the direction, is called the radial internal clearance or the axial internal clearance.

When the internal clearance of a bearing is measured, a slight measurement load is applied to the raceway so the internal clearance may be measured accurately. However, at this time, a slight amount of elastic deformation of the bearing occurs under the measurement load, and the clearance measurement value (measured clearance) is slightly larger than the true clearance. This difference between the true bearing clearance and the increased amount due to the elastic deformation must be compensated for. These compensation values are given in **Table 8.1**. For roller bearings the amount of elastic deformation can be ignored.

The internal clearance values for each bearing class are shown in **Tables 8.3 through 8.11**.

8.2 Internal clearance selection

The internal clearance of a bearing under operating conditions (effective clearance) is usually smaller than the same bearing's initial clearance before being installed and operated. This is due to several factors including bearing fit, the difference in temperature between the inner and outer rings, etc. As a bearing's operating clearance has an effect on bearing life, heat generation, vibration, noise, etc.; care must be taken in selecting the most suitable operating clearance.

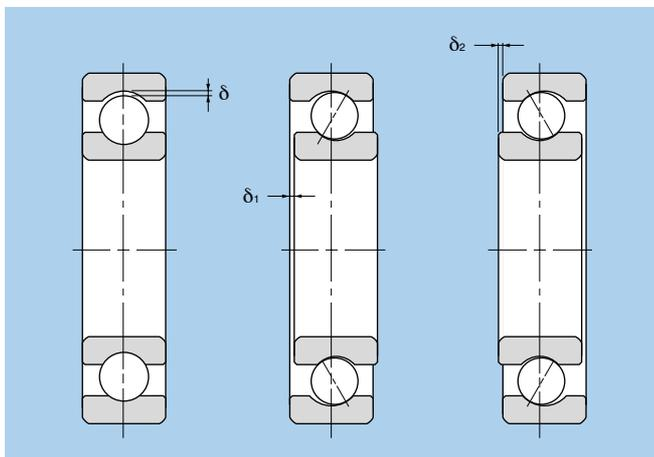

Radial clearance = δ Axial clearance = $\delta_1 + \delta_2$

Fig. 8.1 Internal clearance

8.2.1 Criteria for selecting bearing internal clearance

A bearing's life is theoretically maximum when operating clearance is slightly negative at steady operation. In reality it is however difficult to constantly maintain this optimal condition. If the negative clearance becomes enlarged by fluctuating operating conditions, heat will be produced and life will decrease dramatically. Under ordinary circumstances you should therefore select an initial internal clearance where the operating clearance is slightly larger than zero.

For ordinary operating conditions, use fitting for ordinary loads. If rotational speed and operating temperature are ordinary, selecting normal clearance enables you to obtain the proper operating clearance. **Table 8.2** gives examples applying internal clearances other than CN (normal) clearance.

8.2.2 Calculation of operating clearance

Operating clearance of a bearing can be calculated from initial bearing internal clearance and decrease in internal clearance due to interference and decrease in internal clearance due to difference in temperature of the inner and outer rings.

$$\delta_{\text{eff}} = \delta_o - (\delta_f + \delta_t) \dots\dots\dots (8.1)$$

where,

δ_{eff} : Effective internal clearance, mm

δ_o : Bearing internal clearance, mm

δ_f : Reduced amount of clearance due to

Table 8.1 Adjustment of radial internal clearance based on measured load (deep groove ball bearing) Unit μm

Nominal Bore Diameter d mm	Measuring Load N [kgf]	Internal clearance adjustment						
		over	incl.	C2	CN	C3	C4	C5
10 ^①	18	24.5	{2.5}	3~4	4	4	4	4
18	50	49	{5}	4~5	5	6	6	6
50	200	147	{15}	6~8	8	9	9	9

① This diameter is included in the group.

Table 8.2 Examples of applications where bearing clearances other than CN (normal) clearance are used

Operating conditions	Applications	Selected clearance
With heavy or shock load, clearance is large.	Railway vehicle axles	C3
	Vibration screens	C3, C4
With indeterminate load, both inner and outer rings are tight-fitted.	Railway vehicle traction motors	C4
	Tractors and final speed regulators	C4
Shaft or inner ring is heated.	Paper making machines and driers	C3, C4
	Rolling mill table rollers	C3
Reduction of noise and vibration when rotating.	Micromotors	C2, CM
Adjustment of clearance to minimize shaft runout.	Main spindles of lathes (Double-row cylindrical roller bearings)	C9NA, C0NA
Loose fitting for both inner and outer rings.	Compressor roll neck	C2

interference, mm

δ_t : Reduced amount of clearance due to temperature differential of inner and outer rings, mm

(1) Reduced clearance due to interference

When bearings are installed with interference fits on shafts and in housings, the inner ring will expand and the outer ring will contract; **thus reducing the bearings' internal clearance.** The amount of expansion or contraction varies depending on the shape of the bearing, the shape of the shaft or housing, dimensions of the respective parts, and the type of materials used. The differential can range from approximately **70% to 90% of the effective interference.**

$$\delta_t = (0.70 \sim 0.90) \Delta_{def} \dots\dots\dots (8.2)$$

where,

δ_t : Reduced amount of clearance due to interference, mm

Δ_{def} : Effective interference, mm

(2) Reduced internal clearance due to inner/outer ring temperature difference.

During operation, normally the outer ring will range from 5 to 10°C cooler than the inner ring or rotating parts. However, if the cooling effect of the housing is large, the

shaft is connected to a heat source, or a heated substance is conducted through the hollow shaft; the temperature difference between the two rings can be even greater. **The amount of internal clearance is thus further reduced by the differential expansion of the two rings.**

$$\delta_t = \alpha \cdot \Delta T \cdot D_o \dots\dots\dots (8.3)$$

where,

δ_t : Amount of reduced clearance due to heat differential, mm

α : Bearing material expansion coefficient
 $12.5 \times 10^{-6}/^\circ\text{C}$

ΔT : Inner/outer ring temperature differential, °C

D_o : Outer ring raceway diameter, mm

Outer ring raceway diameter, D_o , values can be approximated by using formula (8.4) or (8.5).

For ball bearings and spherical roller bearings,

$$D_o = 0.20 (d + 4.0D) \dots\dots\dots (8.4)$$

For roller bearings (except Spherical roller bearing),

$$D_o = 0.25 (d + 3.0D) \dots\dots\dots (8.5)$$

where,

d : Bearing bore diameter, mm

D : Bearing outside diameter, mm

Table 8.3 Radial internal clearance of deep groove ball bearings

Unit μm

Nominal bore diameter d mm		C2		CN		C3		C4		C5	
over	incl.	min	max	min	max	min	max	min	max	min	max
—	2.5	0	6	4	11	10	20	—	—	—	—
2.5	6	0	7	2	13	8	23	—	—	—	—
6	10	0	7	2	13	8	23	14	29	20	37
10	18	0	9	3	18	11	25	18	33	25	45
18	24	0	10	5	20	13	28	20	36	28	48
24	30	1	11	5	20	13	28	23	41	30	53
30	40	1	11	6	20	15	33	28	46	40	64
40	50	1	11	6	23	18	36	30	51	45	73
50	65	1	15	8	28	23	43	38	61	55	90
65	80	1	15	10	30	25	51	46	71	65	105
80	100	1	18	12	36	30	58	53	84	75	120
100	120	2	20	15	41	36	66	61	97	90	140
120	140	2	23	18	48	41	81	71	114	105	160
140	160	2	23	18	53	46	91	81	130	120	180
160	180	2	25	20	61	53	102	91	147	135	200
180	200	2	30	25	71	63	117	107	163	150	230
200	225	2	35	25	85	75	140	125	195	175	265
225	250	2	40	30	95	85	160	145	225	205	300
250	280	2	45	35	105	90	170	155	245	225	340
280	315	2	55	40	115	100	190	175	270	245	370
315	355	3	60	45	125	110	210	195	300	275	410
355	400	3	70	55	145	130	240	225	340	315	460
400	450	3	80	60	170	150	270	250	380	350	510
450	500	3	90	70	190	170	300	280	420	390	570
500	560	10	100	80	210	190	330	310	470	440	630
560	630	10	110	90	230	210	360	340	520	490	690

Table 8.4 Radial internal clearance of self-aligning ball bearings

Nominal bore diameter <i>d</i> mm		Bearing with cylindrical bore									
		C2		CN		C3		C4		C5	
over	incl.	min	max	min	max	min	max	min	max	min	max
2.5	6	1	8	5	15	10	20	15	25	21	33
6	10	2	9	6	17	12	25	19	33	27	42
10	14	2	10	6	19	13	26	21	35	30	48
14	18	3	12	8	21	15	28	23	37	32	50
18	24	4	14	10	23	17	30	25	39	34	52
24	30	5	16	11	24	19	35	29	46	40	58
30	40	6	18	13	29	23	40	34	53	46	66
40	50	6	19	14	31	25	44	37	57	50	71
50	65	7	21	16	36	30	50	45	69	62	88
65	80	8	24	18	40	35	60	54	83	76	108
80	100	9	27	22	48	42	70	64	96	89	124
100	120	10	31	25	56	50	83	75	114	105	145
120	140	10	38	30	68	60	100	90	135	125	175
140	160	15	44	35	80	70	120	110	161	150	210

Table 8.5 (1) Radial internal clearance for duplex angular contact ball bearings

Nominal bore diameter <i>d</i> mm		Unit μm									
		C1		C2		CN		C3		C4	
over	incl.	min	max	min	max	min	max	min	max	min	max
—	10	3	8	6	12	8	15	15	22	22	30
10	18	3	8	6	12	8	15	15	24	30	40
18	30	3	10	6	12	10	20	20	32	40	55
30	50	3	10	8	14	14	25	25	40	55	75
50	80	3	11	11	17	17	32	32	50	75	95
80	100	3	13	13	22	22	40	40	60	95	120
100	120	3	15	15	30	30	50	50	75	110	140
120	150	3	16	16	33	35	55	55	80	130	170
150	180	3	18	18	35	35	60	60	90	150	200
180	200	3	20	20	40	40	65	65	100	180	240

Table 8.5 (2) Radial internal clearance of double row angular contact ball bearings

Nominal bore diameter <i>d</i> mm		Unit μm									
		C2		CN		C3		C4		C5	
over	incl.	min	max	min	max	min	max	min	max	min	max
10 only		0	10	5	15	10	21	16	28	24	36
10	18	1	11	6	16	12	23	19	31	28	40
18	24	1	11	6	16	13	24	21	33	31	43
24	30	1	13	6	19	13	26	21	35	31	45
30	40	2	15	7	22	15	30	24	39	35	50
40	50	2	15	9	24	17	32	28	45	40	57
50	65	0	15	7	24	16	33	28	48	41	61
65	80	1	17	11	31	21	42	34	56	50	74
80	100	3	20	13	36	25	49	40	65	58	67

Note: The clearance group in the table is applied only to contact angles in the table below.

Contact angle symbol	Nominal contact angle	Applicable clearance group ^②
C	15°	C1, C2
A ^①	30°	C2, CN, C3
B	40°	CN, C3, C4

① Not indicated for bearing number.

② For information concerning clearance other than applicable clearance, please contact NTN Engineering.

Table 8.6 Radial internal clearance of bearings for electric motor

Nominal bore diameter <i>d</i> mm		Unit μm			
		Radial internal clearance CM			
over	incl.	Deep groove ball bearings		Cylindrical roller bearings	
		min	max	min	max
10 (incl.)	18	4	11	—	—
18	24	5	12	—	—
24	30	5	12	15	30
30	40	9	17	15	30
40	50	9	17	20	35
50	65	12	22	25	40
65	80	12	22	30	45
80	100	18	30	35	55
100	120	18	30	35	60
120	140	24	38	40	65
140	160	24	38	50	80
160	180	—	—	60	90
180	200	—	—	65	100

Note 1: Suffix CM is added to bearing numbers.

Example: 6205ZZCM

2: Clearance not interchangeable for cylindrical roller bearings.

Bearing Internal Clearance and Preload

Unit μm

Bearing with tapered bore										Nominal bore diameter	
C2		CN		C3		C4		C5		d mm	
min	max	min	max	min	max	min	max	min	max	over	incl.
—	—	—	—	—	—	—	—	—	—	2.5	6
—	—	—	—	—	—	—	—	—	—	6	10
—	—	—	—	—	—	—	—	—	—	10	14
—	—	—	—	—	—	—	—	—	—	14	18
7	17	13	26	20	33	28	42	37	55	18	24
9	20	15	28	23	39	33	50	44	62	24	30
12	24	19	35	29	46	40	59	52	72	30	40
14	27	22	39	33	52	45	65	58	79	40	50
18	32	27	47	41	61	56	80	73	99	50	65
23	39	35	57	50	75	69	98	91	123	65	80
29	47	42	68	62	90	84	116	109	144	80	100
35	56	50	81	75	108	100	139	130	170	100	120
40	68	60	98	90	130	120	165	155	205	120	140
45	74	65	110	100	150	140	191	180	240	140	160

Table 8.7 Interchangeable radial internal clearance for cylindrical roller bearing (cylindrical bore)

Unit μm

Nominal bore diameter d mm		C2		CN		C3		C4		C5	
over	incl.	min	max	min	max	min	max	min	max	min	max
—	10	0	25	20	45	35	60	50	75	—	—
10	24	0	25	20	45	35	60	50	75	65	90
24	30	0	25	20	45	35	60	50	75	70	95
30	40	5	30	25	50	45	70	60	85	80	105
40	50	5	35	30	60	50	80	70	100	95	125
50	65	10	40	40	70	60	90	80	110	110	140
65	80	10	45	40	75	65	100	90	125	130	165
80	100	15	50	50	85	75	110	105	140	155	190
100	120	15	55	50	90	85	125	125	165	180	220
120	140	15	60	60	105	100	145	145	190	200	245
140	160	20	70	70	120	115	165	165	215	225	275
160	180	25	75	75	125	120	170	170	220	250	300
180	200	35	90	90	145	140	195	195	250	275	330
200	225	45	105	105	165	160	220	220	280	305	365
225	250	45	110	110	175	170	235	235	300	330	395
250	280	55	125	125	195	190	260	260	330	370	440
280	315	55	130	130	205	200	275	275	350	410	485
315	355	65	145	145	225	225	305	305	385	455	535
355	400	100	190	190	280	280	370	370	460	510	600
400	450	110	210	210	310	310	410	410	510	565	665
450	500	110	220	220	330	330	440	440	550	625	735

Table 8.8 Non-interchangeable radial internal clearance for cylindrical roller bearing

Nominal bore diameter <i>d</i> mm		Bearing with cylindrical bore											
		C1NA		C2NA		NA ^①		C3NA		C4NA		C5NA	
over	incl.	min	max	min	max	min	max	min	max	min	max	min	max
—	10	5	10	10	20	20	30	35	45	45	55	—	—
10	18	5	10	10	20	20	30	35	45	45	55	65	75
18	24	5	10	10	20	20	30	35	45	45	55	65	75
24	30	5	10	10	25	25	35	40	50	50	60	70	80
30	40	5	12	12	25	25	40	45	55	55	70	80	95
40	50	5	15	15	30	30	45	50	65	65	80	95	110
50	65	5	15	15	35	35	50	55	75	75	90	110	130
65	80	10	20	20	40	40	60	70	90	90	110	130	150
80	100	10	25	25	45	45	70	80	105	105	125	155	180
100	120	10	25	25	50	50	80	95	120	120	145	180	205
120	140	15	30	30	60	60	90	105	135	135	160	200	230
140	160	15	35	35	65	65	100	115	150	150	180	225	260
160	180	15	35	35	75	75	110	125	165	165	200	250	285
180	200	20	40	40	80	80	120	140	180	180	220	275	315
200	225	20	45	45	90	90	135	155	200	200	240	305	350
225	250	25	50	50	100	100	150	170	215	215	265	330	380
250	280	25	55	55	110	110	165	185	240	240	295	370	420
280	315	30	60	60	120	120	180	205	265	265	325	410	470
315	355	30	65	65	135	135	200	225	295	295	360	455	520
355	400	35	75	75	150	150	225	255	330	330	405	510	585
400	450	45	85	85	170	170	255	285	370	370	455	565	650
450	500	50	95	95	190	190	285	315	410	410	505	625	720

① For bearings with normal clearance, only NA is added to bearing numbers. Ex. NU310NA

Table 8.9 Axial internal clearance for double row and duplex tapered roller bearings (metric series)

Nominal bore diameter <i>d</i> mm		Contact angle $\alpha \leq 27^\circ$ ($e \leq 0.76$)							
		C2		CN		C3		C4	
over	incl.	min	max	min	max	min	max	min	max
18	24	25	75	75	125	125	170	170	220
24	30	25	75	75	125	145	195	195	245
30	40	25	95	95	165	165	235	210	280
40	50	20	85	85	150	175	240	240	305
50	65	20	85	110	175	195	260	280	350
65	80	20	110	130	220	240	325	325	410
80	100	45	150	150	260	280	390	390	500
100	120	45	175	175	305	350	480	455	585
120	140	45	175	175	305	390	520	500	630
140	160	60	200	200	340	400	540	520	660
160	180	80	220	240	380	440	580	600	740
180	200	100	260	260	420	500	660	660	820
200	225	120	300	300	480	560	740	720	900
225	250	160	360	360	560	620	820	820	1,020
250	280	180	400	400	620	700	920	920	1,140
280	315	200	440	440	680	780	1,020	1,020	1,260
315	355	220	480	500	760	860	1,120	1,120	1,380
355	400	260	560	560	860	980	1,280	1,280	1,580
400	500	300	600	620	920	1,100	1,400	1,440	1,740

Note1: This table applies to bearings contained in the catalog. For information concerning other bearings or bearings using US customary unit, please contact NTN Engineering.

2: The correlation of axial internal clearance (Δ_a) and radial internal clearance (Δ_r) is expressed as $\Delta_r = 0.667 \cdot e \cdot \Delta_a$.

e: Constant (see dimensions table)

3: Bearing series 329X, 330, 322C and 323Cdo not apply to the table.

Unit μm

Bearing with tapered bore												Nominal bore diameter	
C9NA ^②		C0NA ^②		C1NA		C2NA		NA ^①		C3NA		d mm	
min	max	min	max	min	max	min	max	min	max	min	max	over	incl.
5	5	7	17	10	20	20	30	35	45	45	55	—	10
5	10	7	17	10	20	20	30	35	45	45	55	10	18
5	10	7	17	10	20	20	30	35	45	45	55	18	24
5	10	10	20	10	25	25	35	40	50	50	60	24	30
5	12	10	20	12	25	25	40	45	55	55	70	30	40
5	15	10	20	15	30	30	45	50	65	65	80	40	50
5	15	10	20	15	35	35	50	55	75	75	90	50	65
10	20	15	30	20	40	40	60	70	90	90	110	65	80
10	25	20	35	25	45	45	70	80	105	105	125	80	100
10	25	20	35	25	50	50	80	95	120	120	145	100	120
15	30	25	40	30	60	60	90	105	135	135	160	120	140
15	35	30	45	35	65	65	100	115	150	150	180	140	160
15	35	30	45	35	75	75	110	125	165	165	200	160	180
20	40	30	50	40	80	80	120	140	180	180	220	180	200
20	45	35	55	45	90	90	135	155	200	200	240	200	225
25	50	40	65	50	100	100	150	170	215	215	265	225	250
25	55	40	65	55	110	110	165	185	240	240	295	250	280
30	60	45	75	60	120	120	180	205	265	265	325	280	315
30	65	45	75	65	135	135	200	225	295	295	360	315	355
35	75	50	90	75	150	150	225	255	330	330	405	355	400
45	85	60	100	85	170	170	255	285	370	370	455	400	450
50	95	70	115	95	190	190	285	315	410	410	505	450	500

② C9NA, C0NA and C1NA are applied only to precision bearings of Class 5 and higher.

Unit μm

Contact angle $\alpha > 27^\circ$ ($e > 0.76$)								Nominal bore diameter	
C2		CN		C3		C4		d mm	
min	max	min	max	min	max	min	max	over	incl.
10	30	30	50	50	70	70	90	18	24
10	30	30	50	60	80	80	100	24	30
10	40	40	70	70	100	90	120	30	40
10	40	40	70	80	110	110	140	40	50
10	40	50	80	90	120	130	160	50	65
10	50	60	100	110	150	150	190	65	80
20	70	70	120	130	180	180	230	80	100
20	70	70	120	150	200	210	260	100	120
20	70	70	120	160	210	210	260	120	140
30	100	100	160	180	240	240	300	140	160
—	—	—	—	—	—	—	—	160	180
—	—	—	—	—	—	—	—	180	200
—	—	—	—	—	—	—	—	200	225
—	—	—	—	—	—	—	—	225	250
—	—	—	—	—	—	—	—	250	280
—	—	—	—	—	—	—	—	280	315
—	—	—	—	—	—	—	—	315	355
—	—	—	—	—	—	—	—	355	400
—	—	—	—	—	—	—	—	400	500

Table 8.10 Radial internal clearance of spherical roller bearings

Nominal bore diameter <i>d</i> mm		Bearing with cylindrical bore									
		C2		CN		C3		C4		C5	
over	incl.	min	max	min	max	min	max	min	max	min	max
14	18	10	20	20	35	35	45	45	60	60	75
18	24	10	20	20	35	35	45	45	60	60	75
24	30	15	25	25	40	40	55	55	75	75	95
30	40	15	30	30	45	45	60	60	80	80	100
40	50	20	35	35	55	55	75	75	100	100	125
50	65	20	40	40	65	65	90	90	120	120	150
65	80	30	50	50	80	80	110	110	145	145	180
80	100	35	60	60	100	100	135	135	180	180	225
100	120	40	75	75	120	120	160	160	210	210	260
120	140	50	95	95	145	145	190	190	240	240	300
140	160	60	110	110	170	170	220	220	280	280	350
160	180	65	120	120	180	180	240	240	310	310	390
180	200	70	130	130	200	200	260	260	340	340	430
200	225	80	140	140	220	220	290	290	380	380	470
225	250	90	150	150	240	240	320	320	420	420	520
250	280	100	170	170	260	260	350	350	460	460	570
280	315	110	190	190	280	280	370	370	500	500	630
315	355	120	200	200	310	310	410	410	550	550	690
355	400	130	220	220	340	340	450	450	600	600	750
400	450	140	240	240	370	370	500	500	660	660	820
450	500	140	260	260	410	410	550	550	720	720	900
500	560	150	280	280	440	440	600	600	780	780	1,000
560	630	170	310	310	480	480	650	650	850	850	1,100
630	710	190	350	350	530	530	700	700	920	920	1,190
710	800	210	390	390	580	580	770	770	1,010	1,010	1,300
800	900	230	430	430	650	650	860	860	1,120	1,120	1,440
900	1,000	260	480	480	710	710	930	930	1,220	1,220	1,570
1,000	1,120	290	530	530	780	780	1,020	1,020	1,330	1,330	1,720
1,120	1,250	320	580	580	860	860	1,120	1,120	1,460	1,460	1,870
1,250	1,400	350	640	640	950	950	1,240	1,240	1,620	1,620	2,080

Table 8.11 Axial internal clearance of four points contact ball bearings

Unit μm

Nominal bore diameter <i>d</i> mm		C2		CN		C3		C4	
		min	max	min	max	min	max	min	max
over	incl.								
17	40	26	66	56	106	96	146	136	186
40	60	36	86	76	126	116	166	156	206
60	80	46	96	86	136	126	176	166	226
80	100	56	106	96	156	136	196	186	246
100	140	66	126	116	176	156	216	206	266
140	180	76	156	136	196	176	236	226	296
180	220	96	176	156	216	196	256	246	316

Bearing Internal Clearance and Preload

Unit μm

Bearing with tapered bore										Nominal bore diameter	
C2		CN		C3		C4		C5		d mm	
min	max	min	max	min	max	min	max	min	max	over	incl.
—	—	—	—	—	—	—	—	—	—	14	18
15	25	25	35	35	45	45	60	60	75	18	24
20	30	30	40	40	55	55	75	75	95	24	30
25	35	35	50	50	65	65	85	85	105	30	40
30	45	45	60	60	80	80	100	100	130	40	50
40	55	55	75	75	95	95	120	120	160	50	65
50	70	70	95	95	120	120	150	150	200	65	80
55	80	80	110	110	140	140	180	180	230	80	100
65	100	100	135	135	170	170	220	220	280	100	120
80	120	120	160	160	200	200	260	260	330	120	140
90	130	130	180	180	230	230	300	300	380	140	160
100	140	140	200	200	260	260	340	340	430	160	180
110	160	160	220	220	290	290	370	370	470	180	200
120	180	180	250	250	320	320	410	410	520	200	225
140	200	200	270	270	350	350	450	450	570	225	250
150	220	220	300	300	390	390	490	490	620	250	280
170	240	240	330	330	430	430	540	540	680	280	315
190	270	270	360	360	470	470	590	590	740	315	355
210	300	300	400	400	520	520	650	650	820	355	400
230	330	330	440	440	570	570	720	720	910	400	450
260	370	370	490	490	630	630	790	790	1,000	450	500
290	410	410	540	540	680	680	870	870	1,100	500	560
320	460	460	600	600	760	760	980	980	1,230	560	630
350	510	510	670	670	850	850	1,090	1,090	1,360	630	710
390	570	570	750	750	960	960	1,220	1,220	1,500	710	800
440	640	640	840	840	1,070	1,070	1,370	1,370	1,690	800	900
490	710	710	930	930	1,190	1,190	1,520	1,520	1,860	900	1,000
530	770	770	1,030	1,030	1,300	1,300	1,670	1,670	2,050	1,000	1,120
570	830	830	1,120	1,120	1,420	1,420	1,830	1,830	2,250	1,120	1,250
620	910	910	1,230	1,230	1,560	1,560	2,000	2,000	2,470	1,250	1,400

8.3 Preload

Normally, bearings are used with a slight internal clearance under operating conditions. However, in some applications, bearings are given an initial load; this means that the bearings' internal clearance is negative before operation. This is called "preload" and is commonly applied to angular ball bearings and tapered roller bearings.

8.3.1 Purpose of preload

The following results are obtained by constant elastic compressive force applied to the contact points of rolling elements and raceway by providing preload.

- (1) Bearing's rigidity increases, internal clearance tends not to be produced even when heavy load is applied.
- (2) The particular frequency of the bearing increases and is becomes suitable for high-speed rotation.
- (3) Shaft runout is suppressed; rotation and position precision are enhanced.
- (4) Vibration and noise are controlled.
- (5) Sliding of rolling elements by turning, spinning, or pivoting, is controlled and smearing is reduced.
- (6) Fretting produced by external vibration is prevented.

Applying excessive preload could result in reduction of life, abnormal heating, or increase in turning torque. You should therefore consider the objectives before determining the amount of preload.

Table 8.12 Preloading methods and characteristics

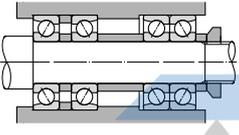
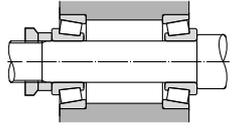
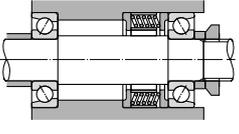
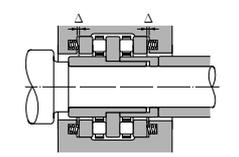
Method	Basic pattern	Applicable bearings	Object	Characteristics	Applications
Fixed position preload		Angular contact ball bearings	Maintaining accuracy of rotating shaft, preventing vibration increasing rigidity	Preloading is accomplished by a predetermined offset of the rings or by using spacers. For the standard preload see Table 8.13.	Grinding machines, lathes, milling machines, measuring instruments
		Tapered roller bearings, thrust ball bearings, angular contact ball bearings	Increasing bearing rigidity	Preload is accomplished by adjusting a threaded screw. The amount of preload is set by measuring the starting torque or axial displacement.	Lathes, milling machines, differential gears of automotives, printing machines, wheel axles
Constant pressure preload		Angular contact ball bearings, deep groove ball bearings, tapered roller bearings (high speed)	Maintaining accuracy and preventing vibration and noise with a constant amount of preload without being affected by loads or temperature	Preloading is accomplished by using coil or belleville springs. for deep groove ball bearings: $4 \sim 10 d$ N $0.4 \sim 1.0 d$ {kgf} d : Shaft diameter mm for angular contact ball bearings: see Table 8.13.	Internal grinding machines, electric motors, high speed shafts in small machines, tension reels
		Spherical roller thrust bearings, cylindrical roller thrust bearings, thrust ball bearings	Preload is primarily used to prevent smearing of opposite axial load side when bearing an axial load.	Preload is accomplished by using coil or belleville springs. Recommended preloads are as follows: for thrust ball bearings: $T_1 = 0.42 (nC_{oa})^{1.9} \times 10^{-13}$ N $= 3.275 (nC_{oa})^{1.9} \times 10^{-13}$ {kgf} $T_2 = 0.00083 C_{oa}$ N {kgf} which ever is greater for spherical roller thrust bearings, cylindrical roller thrust bearing $T = 0.025 C_{oa}^{0.8}$ N $= 0.0158 C_{oa}^{0.8}$ {kgf}	Rolling mills, extruding machines

Note: In the above formulas T = preload, N {kgf} n = number of revolutions, min⁻¹ C_{oa} = basic static axial load rating, N {kgf}

8.3.2 Preloading methods and amounts

The most common method of applying preload on a bearing is change the relative position of the inner and outer rings of the bearing in the axial direction while applying an axial load between bearings on opposing sides. There are two types of preload: fixed position preload and constant pressure preload.

The basic pattern, purpose and characteristics of bearing preloads are shown in **Table 8.12**. The fixed position preload is effective for positioning the two bearings and also for increasing the rigidity. Due to the use of a spring for the constant pressure preload, the preloading amount can be kept constantly, even when the distance between the two bearings fluctuates under the influence of operating heat and load.

Also, the standard preloading amount for the paired angular contact ball bearings is shown in **Table 8.13**. Light and normal preload is applied to prevent general vibration, and medium and heavy preload is applied especially when rigidity is required.

8.3.3 Preload and rigidity

The increased rigidity effect preloading has on bearings is shown in **Fig. 8.2**. When the offset inner rings of the two paired angular contact ball bearings are pressed together, each inner ring is displaced axially by the amount δ_o and is thus given a preload, F_o , in the direction. Under this condition, when external axial load F_a is applied, bearing I will have an increased displacement by the amount δ_a and bearing II's displacement will decrease. At this time the loads applied to bearing I and II are F_{I} and F_{II} , respectively.

Under the condition of no preload, bearing I will be displaced by the amount δ_b when axial load F_a is applied. Since the amount of displacement, δ_a , is less than δ_b , it indicates a higher rigidity for δ_a .

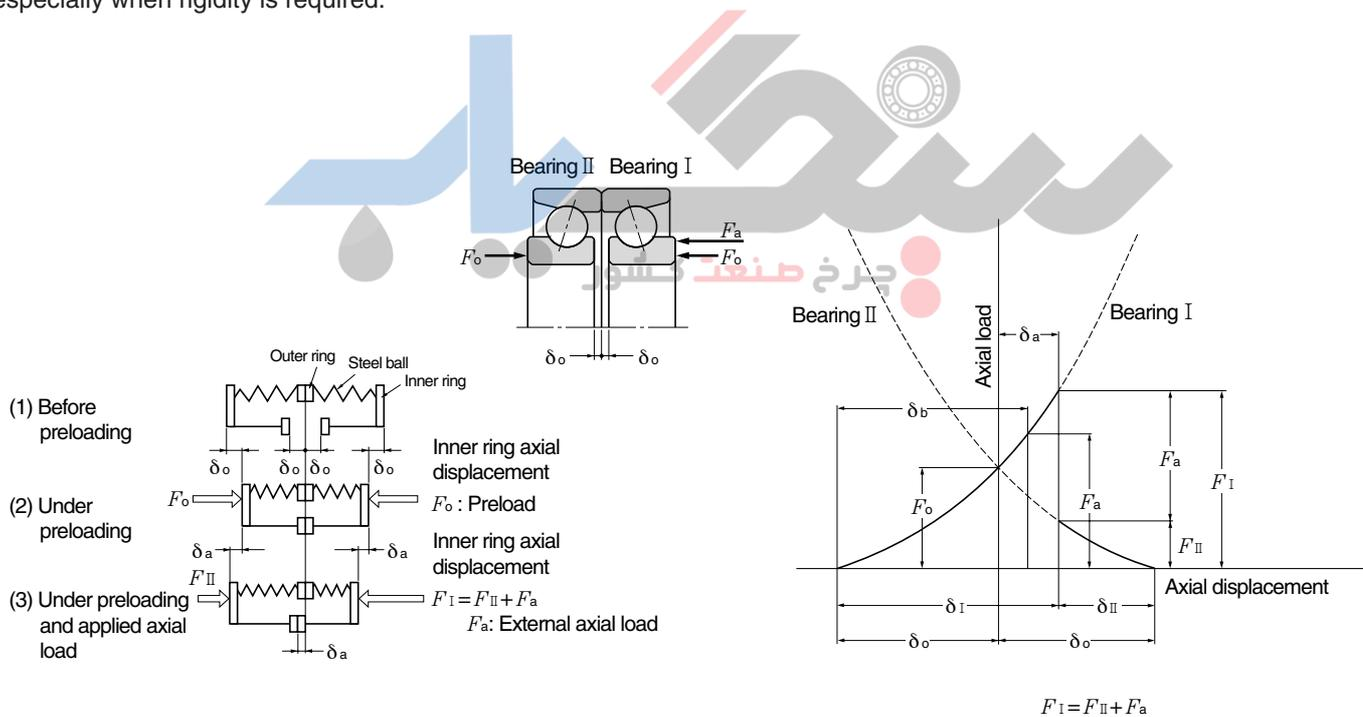

Fig. 8.2 Fixed position preload model diagram and preload diagram

Table 8.13 The normal preload of duplex angular contact ball bearings

Nominal bore diameter <i>d</i> mm		Bearing							
		79				70			
over	incl.	Low GL	Normal GN	Central GM	Heavy GH	Low GL	Normal GN	Central GM	Heavy GH
—	12	—	39 { 4}	78 { 8}	147 { 15}	29 { 3}	78 { 8}	147 { 15}	196 { 20}
12	18	—	49 { 5}	147 { 15}	196 { 20}	29 { 3}	78 { 8}	147 { 15}	294 { 30}
18	32	29 { 3}	98 { 10}	196 { 20}	294 { 30}	49 { 5}	147 { 15}	294 { 30}	490 { 50}
32	40	49 { 5}	147 { 15}	294 { 30}	590 { 60}	78 { 8}	294 { 30}	590 { 60}	885 { 90}
40	50	49 { 5}	196 { 20}	390 { 40}	685 { 70}	78 { 8}	294 { 30}	590 { 60}	980 { 100}
50	65	78 { 8}	245 { 25}	490 { 50}	785 { 80}	147 { 15}	490 { 50}	880 { 90}	1,470 { 150}
65	80	98 { 10}	390 { 40}	785 { 80}	1,180 { 120}	147 { 15}	590 { 60}	1,470 { 150}	1,960 { 200}
80	90	147 { 15}	490 { 50}	980 { 100}	1,470 { 150}	196 { 20}	885 { 90}	1,960 { 200}	2,940 { 300}
90	95	147 { 15}	490 { 50}	980 { 100}	1,470 { 150}	196 { 20}	885 { 90}	1,960 { 200}	2,940 { 300}
95	100	196 { 20}	685 { 70}	1,270 { 130}	1,960 { 200}	196 { 20}	885 { 90}	1,960 { 200}	2,940 { 300}
100	105	196 { 20}	685 { 70}	1,270 { 130}	1,960 { 200}	294 { 30}	980 { 100}	2,450 { 250}	3,900 { 400}
105	110	196 { 20}	685 { 70}	1,270 { 130}	1,960 { 200}	294 { 30}	980 { 100}	2,450 { 250}	3,900 { 400}
110	120	245 { 25}	885 { 90}	1,780 { 180}	2,940 { 300}	294 { 30}	980 { 100}	2,450 { 250}	3,900 { 400}
120	140	294 { 30}	980 { 100}	1,960 { 200}	3,450 { 350}	490 { 50}	1,470 { 150}	3,450 { 350}	5,900 { 600}
140	150	390 { 40}	1,270 { 130}	2,450 { 250}	4,400 { 450}	490 { 50}	1,470 { 150}	3,450 { 350}	5,900 { 600}
150	160	390 { 40}	1,270 { 130}	2,450 { 250}	4,400 { 450}	685 { 70}	2,450 { 250}	4,900 { 500}	8,850 { 900}
160	170	390 { 40}	1,270 { 130}	2,450 { 250}	4,400 { 450}	685 { 70}	2,450 { 250}	4,900 { 500}	8,850 { 900}
170	180	490 { 50}	1,770 { 180}	3,450 { 350}	5,900 { 600}	685 { 70}	2,450 { 250}	4,900 { 500}	8,850 { 900}
180	190	490 { 50}	1,770 { 180}	3,450 { 350}	5,900 { 600}	885 { 90}	3,450 { 350}	6,850 { 700}	9,800 { 1,000}
190	200	685 { 70}	2,450 { 250}	4,900 { 500}	7,850 { 800}	885 { 90}	3,450 { 350}	6,850 { 700}	9,800 { 1,000}

Bearing Internal Clearance and Preload

unit N {kgf}

series							
72, 72B				73, 73B			
Low GL	Normal GN	Central GM	Heavy GH	Low GL	Normal GN	Central GM	Heavy GH
29 { 3}	98 { 10}	196 { 20}	294 { 30}	49 { 5}	147 { 15}	294 { 30}	390 { 40}
29 { 3}	98 { 10}	294 { 30}	390 { 40}	49 { 5}	147 { 15}	390 { 40}	490 { 50}
78 { 8}	196 { 20}	490 { 50}	785 { 80}	98 { 10}	294 { 30}	590 { 60}	980 { 100}
98 { 10}	390 { 40}	885 { 90}	1,470 { 150}	147 { 15}	490 { 50}	980 { 100}	1,960 { 200}
147 { 15}	590 { 60}	980 {100}	1,960 { 200}	196 { 20}	785 { 80}	1,470 { 150}	2,450 { 250}
196 { 20}	785 { 80}	1,470 {150}	2,940 { 300}	294 { 30}	980 {100}	2,450 { 250}	3,900 { 400}
294 { 30}	980 {100}	2,450 {250}	3,900 { 400}	390 { 40}	1,470 {150}	3,450 { 350}	4,900 { 500}
490 { 50}	1,470 {150}	2,940 {300}	4,900 { 500}	590 { 60}	1,960 {200}	3,900 { 400}	5,900 { 600}
490 { 50}	1,960 {200}	3,900 {400}	5,900 { 600}	590 { 60}	2,450 {250}	4,900 { 500}	6,850 { 700}
490 { 50}	1,960 {200}	3,900 {400}	5,900 { 600}	590 { 60}	2,450 {250}	4,900 { 500}	6,850 { 700}
590 { 60}	2,450 {250}	4,900 {500}	7,850 { 800}	685 { 70}	2,940 {300}	5,900 { 600}	8,850 { 900}
590 { 60}	2,450 {250}	4,900 {500}	7,850 { 800}	685 { 70}	2,940 {300}	5,900 { 600}	8,850 { 900}
590 { 60}	2,450 {250}	4,900 {500}	7,850 { 800}	685 { 70}	2,940 {300}	5,900 { 600}	8,850 { 900}
785 { 80}	2,940 {300}	5,900 {600}	9,800 {1,000}	885 { 90}	3,900 {400}	7,850 { 800}	11,800 {1,200}
785 { 80}	2,940 {300}	5,900 {600}	9,800 {1,000}	885 { 90}	3,900 {400}	7,850 { 800}	11,800 {1,200}
885 { 90}	3,900 {400}	7,850 {800}	11,800 {1,200}	980 {100}	4,400 {450}	8,800 { 900}	13,700 {1,400}
885 { 90}	3,900 {400}	7,850 {800}	11,800 {1,200}	980 {100}	4,400 {450}	8,800 { 900}	13,700 {1,400}
885 { 90}	3,900 {400}	7,850 {800}	11,800 {1,200}	980 {100}	4,400 {450}	8,800 { 900}	13,700 {1,400}
980 {100}	4,400 {450}	8,850 {900}	13,700 {1,400}	1,470 {150}	5,900 {600}	11,800 {1,200}	15,700 {1,600}
980 {100}	4,400 {450}	8,850 {900}	13,700 {1,400}	1,470 {150}	5,900 {600}	11,800 {1,200}	15,700 {1,600}

9. Allowable Speed

As rotational speed of the bearing increase, the temperature of the bearing also rises due to heat produced inside the bearing by friction. This causes damage to the bearing such as seizure, and the bearing will be unable to continue stable operation. Therefore, the maximum speed at which it is possible for the bearing to continuously operate without the generation of excessive heat beyond specified limits, is called the **allowable speed** (min^{-1}).

The allowable speed of a bearing depends on the type of bearing, bearing dimensions, type of cage, load, lubricating conditions, and cooling conditions.

The bearing dimensions table gives approximate allowable rotational speeds for grease and oil lubrication. The values are based on the following:

- The bearing must have the proper internal clearance prescribed in the NTN Engineering standard design specifications and must be properly installed.
- A quality lubricant must be used. The lubricant must be replenished and changed when necessary.
- The bearing must be operated at normal operating temperature under ordinary load conditions ($P \leq 0.09 C_r, F_a / F_r \leq 0.3$).

If load is $P \leq 0.04 C_{or}$, the rolling elements may not turn smoothly. If so, please contact NTN Engineering for more information. Allowable rotational speed for deep groove ball bearings with contact seal (LLU type) or low-torque seal (LLH type) is determined according to the circumferential speed of the seal.

For bearings to be used under heavier than normal load conditions, the allowable speed values listed in the bearing tables must be multiplied by an adjustment factor. The adjustment factors f_L and f_C are given in **Figs. 9.1** and **9.2**.

Also, when radial bearings are mounted on vertical shafts, lubricant retentions and cage guidance are not favorable compared to horizontal shaft mounting.

Therefore, the allowable speed should be reduced to **approximately 80% of the listed speed**.

For speeds other than those mentioned above, and for which data is incomplete, please consult NTN Engineering.

If rotational speed is to exceed allowable rotational speed given in the dimensions table, it will require special considerations such as using a bearing for which cage specifications, internal clearance and precision have been thoroughly checked. It will also require adopting forced circulation, jet oil or mist oil lubrication as the lubrication method.

Under such high speed operating conditions, when special care is taken, the standard allowable speeds given in the bearing tables can be adjusted upward. The maximum speed adjustment values, f_B , by which the bearing table speeds can be multiplied, are shown in **Table 9.1**. However, for any application requiring speeds in excess of the standard allowable speed, please consult NTN Engineering.

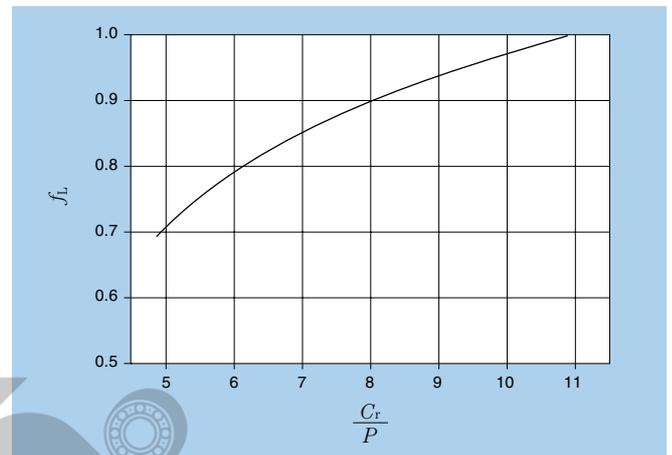

Fig. 9.1 Value of adjustment factor f_L depends on bearing load

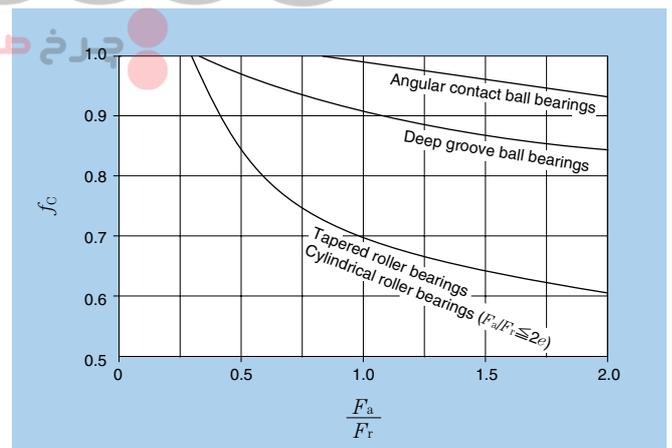

Fig. 9.2 Value of adjustment factor f_C depends on combined load

Table 9.1 Adjustment factor, f_B , for allowable number of revolutions

Type of bearing	Adjustment factor f_B
Deep groove ball bearings	3.0
Angular contact ball bearings	2.0
Cylindrical roller bearings	2.5
Tapered roller bearings	2.0

10. Friction and Temperature Rise

10.1 Friction

One of the main functions required of a bearing is that it must have low friction. Under normal operating conditions rolling bearings have a much smaller friction coefficient than the slide bearings, especially starting friction.

The friction coefficient for rolling bearings is expressed by formula (10.1).

$$\mu = \frac{2M}{Pd} \dots\dots\dots (10.1)$$

where,

- μ : Friction coefficient
- M : Friction moment, N · mm {kgf · fmm}
- P : Load, N {kgf}
- d : Bearing bore diameter, mm

Although the dynamic friction coefficient for rolling bearings varies with the type of bearings, load, lubrication, speed, and other factors; for normal operating conditions, the approximate friction coefficients for various bearing types are listed in **Table 10.1**.

Table 10.1 Friction coefficient for bearings (reference)

Bearing type	Coefficient $\mu \times 10^{-3}$
Deep groove ball bearings	1.0~1.5
Angular contact ball bearings	1.2~1.8
Self-aligning ball bearings	0.8~1.2
Cylindrical roller bearings	1.0~1.5
Needle roller bearings	2.0~3.0
Tapered roller bearings	1.7~2.5
Spherical roller bearings	2.0~2.5
Thrust ball bearings	1.0~1.5
Thrust roller bearings	2.0~3.0

10.2 Temperature rise

Almost all friction loss in a bearing is transformed into heat within the bearing itself and causes the temperature of the bearing to rise. The amount of thermal generation caused by friction moment can be calculated using formula (10.2).

$$\left. \begin{aligned} Q &= 0.105 \times 10^{-6} M n \text{ N} \\ &= 1.03 \times 10^{-6} M n \text{ {kgf}} \end{aligned} \right\} \dots\dots\dots (10.2)$$

where,

- Q : Thermal value, kW
- M : Friction moment, N · mm {kgf · fmm}
- n : Rotational speed, min⁻¹

Bearing operating temperature is determined by the equilibrium or balance between the amount of heat generated by the bearing and the amount of heat conducted away from the bearing. In most cases the temperature rises sharply during initial operation, then increases slowly until it reaches a stable condition and then remains constant. The time it takes to reach this stable state depends on the amount of heat produced, heat capacity/diffusion of the shaft and bearing housing, amount of lubricant and method of lubrication. If the temperature continues to rise and does not become constant, it must be assumed that there is some improper function.

Possible causes of abnormal temperature include bearing misalignment (due to moment load or incorrect installation), insufficient internal clearance, excessive preload, too much or too little lubricant, or heat produced from sealed units. Check the mechanical equipment, and if necessary, remove and inspect the bearing.

11. Lubrication

11.1 Purpose of lubrication

The purpose of bearing lubrication is to prevent direct metallic contact between the various rolling and sliding elements. This is accomplished through the formation of a thin oil (or grease) film on the contact surfaces. However, for rolling bearings, lubrication has the following advantages:

- (1) **Reduction of friction and wear**
- (2) **Dissipation of friction heat**
- (3) **Prolonged bearing life**
- (4) **Prevention of rust**
- (5) **Protection against harmful elements**

In order to exhibit these effects, a lubrication method that matches service conditions. In addition to this, a quality lubricant must be selected, the proper amount of lubricant must be used and the bearing must be designed to prevent foreign matter from getting in or lubricant from leaking out.

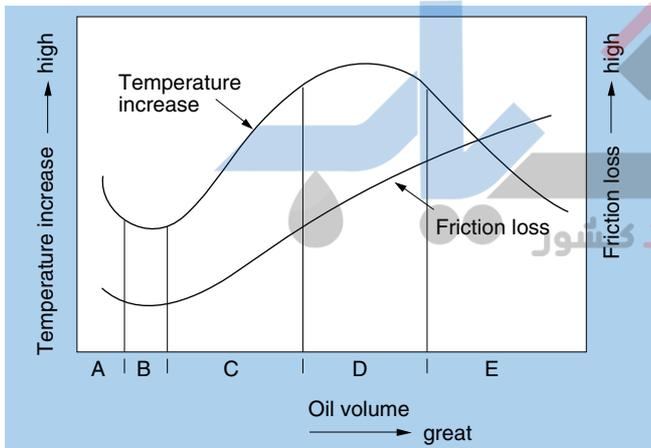

Fig. 11.1

Table 11.1 Oil volume, friction loss, bearing temperature (See Fig. 11.1)

Range	Characteristics	Lubrication method
A	When oil volume is extremely low, direct metallic contact occurs in places between the rolling elements and raceway surfaces. Bearing abrasion and seizing occur.	—
B	A thin oil film develops over all surfaces, friction is minimal and bearing temperature is low.	Grease lubrication, oil mist, air-oil lubrication
C	As oil volume increases, heat buildup is balanced by cooling.	Circulating lubrication
D	Regardless of oil volume, temperature increases at a fixed rate.	Circulating lubrication
E	As oil volume increases, cooling predominates and bearing temperature decreases.	Forced circulation lubrication, Oil jet lubrication

Fig. 11.1 shows the relationship between oil volume, friction loss, and bearing temperature. Table 11.1 details the characteristics of this relationship.

11.2 Lubrication methods and characteristics

Lubrication method for bearings can be roughly divided into grease and oil lubrication. Each of these has its own features, so the lubrication method that best offers the required function must be selected.

The characteristic are shown in Table 11.2.

Table 11.2 Comparison of grease lubrication and oil lubrication characteristics

Concern	Method	Grease lubrication	Oil lubrication
Handling		◎	△
Reliability		○	◎
Cooling effect		×	○ (Circulation necessary)
Seal structure		○	△
Power loss		○	○
Environment contamination		○	△
High speed rotation		×	○

◎ : Very good ○ : Good △ : Fair × : Poor

11.3 Grease lubrication

Grease lubricants are relatively easy to handle and require only the simplest sealing devices. For these reasons, grease is the most widely used lubricant for rolling bearings. It is used a bearing that is pre-sealed with grease (sealed/shield bearing), or if using an unsealed bearing, fill the bearing and housing with the proper amount of grease, and replenish or change the grease regularly.

11.3.1 Types and characteristics of grease

Lubricating grease are composed of either a mineral oil base or a synthetic oil base. To this base a thickener and other additives are added. The properties of all greases are mainly determined by the kind of base oil used and by the combination of thickening agent and various additives. Table 11.5 shows general grease varieties and characteristics, and Table 11.6 shows grease brand names and their natures. (See pages A-74 and A-75.) As performance characteristics of even the same type of grease will vary widely from brand to brand, **it is necessary to check the manufacturers' data when selecting a grease.**

(1) Base oil

Mineral oil or synthetics such as ester or ether oil are used as the base of the grease.

Mainly, the properties of any grease is determined by the properties of the base oil. Generally, greases with low

viscosity base oil are best suited for low temperatures and high speeds; Grease using high-viscosity base oil has superior high-temperature and high-load characteristics.

(2) Thickening agents

Thickening agents are compounded with base oils to maintain the semi-solid state of the grease. Thickening agents consist of two types of bases, metallic soaps and non-soaps. Metallic soap thickeners include: lithium, sodium, calcium, etc.

Non-soap base thickeners are divided into two groups; inorganic (silica gel, bentonite, etc.) and organic (poly-urea, fluorocarbon, etc.).

The various special characteristics of a grease, such as limiting temperature range, mechanical stability, water resistance, etc. depend largely on the type of thickening agent used. For example, a sodium based grease is generally poor in water resistance properties, while greases with bentone, poly-urea and other non-metallic soaps as the thickening agent are generally superior in high temperature properties.

(3) Additives

Various additives are added to greases to improve various properties and efficiency. For example, there are anti-oxidents, high-pressure additives (EP additives), rust preventives, and anti-corrosives.

For bearings subject to heavy loads and/or shock loads, a grease containing high-pressure additives should be used. For comparatively high operating temperatures or in applications where the grease cannot be replenished for long periods, a grease with an oxidation stabilizer is best to use.

(4) Consistency

Consistency is an index that indicates hardness and fluidity of grease. The higher the number, the softer the grease is. The consistency of a grease is determined by the amount of thickening agent used and the viscosity of the base oil. For the lubrication of rolling bearings, greases with the NLGI consistency numbers of 1, 2, and 3 are used.

General relationships between consistency and application of grease are shown in **Table 11.3**.

(5) Mixing of greases

When greases of different kinds are mixed together, the consistency of the greases will change (usually softer), the operating temperature range will be lowered, and other changes in characteristics will occur. As a rule, grease should not be mixed with grease of any other brand.

However, if different greases must be mixed, at least greases with the same base oil and thickening agent should be selected.

Table 11.3 Consistency of grease

NLGI Consistency No.	JIS (ASTM) 60 times blend consistency	Applications
0	355~385	For centralized greasing use
1	310~340	For centralized greasing use
2	265~295	For general use and sealed bearing use
3	220~250	For general use and high temperature use
4	175~205	For special use

11.3.2 Amount of grease

The amount of grease used in any given situation will depend on many factors relating to the size and shape of the housing, space limitations, bearing's rotating speed and type of grease used.

As a rule of thumb, bearings should be filled to 30 to 40% of their space and housing should be filled 30 to 60%.

Where speeds are high and temperature rises need to be kept to a minimum, a reduced amount of grease should be used. **Excessive amount of grease cause temperature rise which in turn causes the grease to soften and may allow leakage. With excessive grease fills oxidation and deterioration may cause lubricating efficiency to be lowered.**

Moreover, the standard bearing space can be found by formula (11.1)

$$V=K \cdot W \dots\dots\dots (11.1)$$

where,

V : Quantity of bearing space open type (approx.), cm³

K : Bearing space factor (see value of *K* in **Table 11.4**)

W: Mass of bearing, kg

Table 11.4 Bearing space factor *K*

Bearing type	Cage type	<i>K</i>
Ball bearings ①	Pressed cage	61
NU-type cylindrical roller bearings ②	Pressed cage	50
	Machined cage	36
N-type cylindrical roller bearings ③	Pressed cage	55
	Machined cage	37
Tapered roller bearings	Pressed cage	46
Spherical roller bearings	Pressed cage	35
	Machined cage	28

① Does not apply top 160 series bearings.

② Does not apply to NU4 series bearings.

③ Does not apply to N4 series bearings.

Table 11.5 Grease varieties and characteristics

Grease name	Lithium grease			Sodium grease (Fiber grease)	Calcium compound base grease
Thickener	Li soap			Na soap	Ca+Na soap Ca+Li soap
Base oil	Mineral oil	Diester oil	Silicone oil	Mineral oil	Mineral oil
Dropping point °C	170 ~ 190	170 ~ 190	200 ~ 250	150 ~ 180	150 ~ 180
Operating temperature range °C	-30 ~ +130	-50 ~ +130	-50 ~ +160	-20 ~ +130	-20 ~ +120
Mechanical stability	Excellent	Good	Good	Excellent ~ Good	Excellent ~ Good
Pressure resistance	Good	Good	Poor	Good	Excellent ~ Good
Water resistance	Good	Good	Good	Good ~ Poor	Good ~ Poor
Applications	Widest range of applications. Grease used in all types of rolling bearings.	Excellent low temperature and wear characteristics. Suitable for small sized and miniature bearings.	Suitable for high and low temperatures. Unsuitable for heavy load applications due to low oil film strength.	Some emulsification when water is introduced. Excellent characteristics at relatively high temperatures.	Excellent pressure resistance and mechanical stability. Suitable for bearings receiving shock loads.

Table 11.6 Grease brands and their nature

Manufacturer	Brand name	NTN code	Thickener	Base oil
Showa Shell Sekiyu	Alvania Grease S2	2AS	Lithium	Mineral oil
	Alvania Grease S3	3AS	Lithium	Mineral oil
	Alvania EP Grease 2	8A	Lithium	Mineral oil
	Aero Shell Grease 7	5S	Microgel	Diester
Kyodo Yushi	Multemp PS No. 2	1K	Lithium	Diester
	Multemp SRL	5K	Lithium	Tetraesterdiester
	E5	L417	Urea	Ether
Esso Sekiyu	Temprex N3 / Unilex N3	2E	Complex Li	Synthetic hydrocarbon
	Beacon 325	3E	Lithium	Diester
NOK Kluber	Isoflex Super LDS18	6K	Lithium	Diester
	Barrierta JFE552	LX11	Fluoride	Fluoride oil
	Grease J	L353	Urea	Ester
Toray Dow Corning, Silicone	SH33L	3L	Lithium	Methyl phenyl oil
	SH44M	4M	Lithium	Methyl phenyl oil
Nippon Oil	Multi Nok wide No. 2	6N	Sodium lithium	Diester mineral oil
	U-4	L412	Urea	Synthetic hydrocarbon + dialkyldiphenyl ether
Nihon Grease	MP-1	L448	Diurea	PAO + ester
Idemitsu Kosan	Apolo Autolex A	5A	Lithium	Mineral oil
Mobil Sekiyu	Mobile Grease 28	9B	Bentone	Synthetic hydrocarbon
Cosmo Oil	Cosmo Wide Grease WR3	2M	Na terephthalate	Diester mineral oil
Daikin	Demnum L200	LX23	PTFE	Fluoride oil

Note: For nature, see the manufacturer's catalog.

Aluminum grease	Non-soap base grease	
Al soap	Bentone, silica gel, urea, carbon black, fluorine compounds, etc.	
Mineral oil	Mineral oil	Synthetic oil
70 ~ 90	250 or above	250 or above
-10 ~ +80	-10 ~ +130	-50 ~ +200
Good ~ Poor	Good	Good
Good	Good	Good
Good	Good	Good
Excellent adhesion	Can be used in a wide range of low to high temperatures. Shows excellent heat resistance, cold resistance, chemical resistance, and other characteristics when matched with a suitable base oil and thickener.	
Suitable for bearings receiving vibration	Grease used in all types of rolling bearings.	

Base oil viscosity	Consistency	Dropping point °C	Operating temperature °C	Color	Characteristics
37.8°C 140mm ² /s	273	181	-25~120	Amber	All-purpose grease
37.8°C 140mm ² /s	232	183	-25~135	Amber	All-purpose grease
98.9°C 15.3mm ² /s	276	187	-20~110	Brown	All-purpose extreme-pressure
98.9°C 3.1mm ² /s	288	Min. 260	-73~149	Yellow-brown	MIL-G-23827
37.8°C 15.3mm ² /s	265~295	190	-55~130	White	For low temperature and low torque
40°C 26mm ² /s	250	192	-40~150	White	Wide range
40°C 72.3mm ² /s	300	240	-30~180	White	For high temperature
40°C 113mm ² /s	220~250	Min. 300	-30~160	Green	For high temperature
40°C 11.5mm ² /s	265~295	177	-60~120	Brown	For low temperature and low torque
40°C 16.0mm ² /s	265~295	Min. 180	-60~130	Yellow-green	For low temperature and low torque
40°C 400mm ² /s	290	—	-35~250	White	
40°C 75mm ² /s	—	280	-20~180	Gray-white	For high temperature
25°C 100mm ² /s	300	200	-70~160	Light red-gray	For low temperature
40°C 32mm ² /s	260	210	-40~180	Brown	For high temperature
37.8°C 30.9mm ² /s	265~295	215	-40~135	Light brown	Wide range
40°C 58mm ² /s	255	260	-40~180	Milk-white	For high temperature
40°C 40.6mm ² /s	243	254	-40~150	Light brown	Wide range
37.8°C 50mm ² /s	265~295	192	-25~150	Yellow	All-purpose grease
40°C 28mm ² /s	315	Min. 260	-62~177	Red	MIL-G-81322C Wide range
37.8°C 30.1mm ² /s	265~295	Min. 230	-40~150	Light brown	Wide range
40°C 200mm ² /s	280	—	-60~300	White	

11.3.3 Grease replenishment

As the lubricating efficiency of grease declines with the passage of time, fresh grease must be re-supplied at proper intervals. The replenishment time interval depends on the type of bearing, dimensions, bearing's rotating speed, bearing temperature, and type of grease.

An easy reference chart for calculating grease replenishment intervals is shown in **Fig. 11.2**.

This chart indicates the replenishment interval for standard rolling bearing grease when used under normal operating conditions.

As operating temperatures increase, the grease re-supply interval should be shortened accordingly.

Generally, for every 10°C increase in bearing temperature above 80°C, the relubrication period is reduced to "1/1.5".

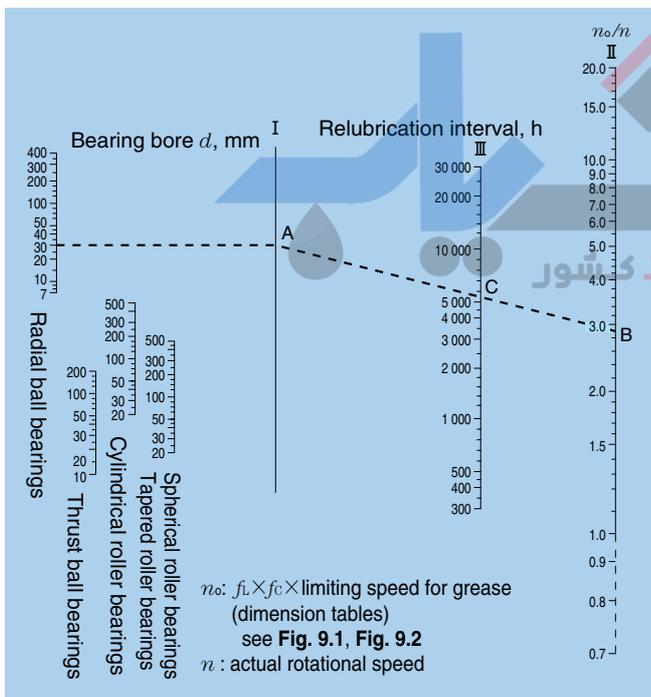

Fig. 11.2 Diagram for relubrication interval of greasing

(Example)

Find the grease relubrication time limit for deep groove ball bearing **6206**, with a radial load of 2.0 kN {204kgf} operating at 3,600 min⁻¹.

$C_r / P_r = 19.5 / 2.0 \text{ kN} = 9.8$ from **Fig. 11.1**, the adjustment factor, f_L , is 0.96.

Allowable rotational speed from the dimensions tables for bearing 6206 is 11,000 min⁻¹. Allowable rotational speed n_0 for a 2.0 kN {204 kgf} radial load is:

$$n_0 = 0.96 \times 11,000 = 10,560 \text{ min}^{-1}$$

$$\text{therefore, } \frac{n_0}{n} = \frac{10,560}{3,600} = 2.93$$

The point where vertical line I intersects a horizontal line drawn from the point equivalent of $d = 30$ for the radial ball bearing shown in **Fig. 11.2** shall be point A. Find intersection point C where vertical line II intersects the straight line formed by joining point B ($n_0/n = 2.93$) with A with a straight line. It shows that grease life in this case is approximately 5,500 hours.

11.4 Solid grease (For bearings with solid grease)

"Solid grease" is a lubricant composed mainly of lubricating grease and ultra-high polymer polyethylene. Solid grease has the same viscosity as grease at normal temperature, If heated once and cooled (this process is referred to as "calcination") the grease hardens while maintaining a large quantity of lubricant. The result of this solidification is that the grease does not easily leak from the bearing, even when the bearing is subjected to strong vibrations or centrifugal force.

Bearings with solid grease are available in two types: the spot-pack type in which solid grease is injected into the cage, and the full-pack type in which all empty space around the rolling elements is filled with solid grease.

Spot-pack solid grease is standard for deep groove ball bearings, small diameter ball bearings, and bearing units. Full-pack solid grease is standard for self-aligning ball bearings, spherical roller bearings, and needle roller bearings.

Primary advantages:

- (1) Grease leakage is minimal.
- (2) Low bearing torque with spot-pack type solid grease

For more details, please refer to NTN special catalog of **Solid grease bearings**.

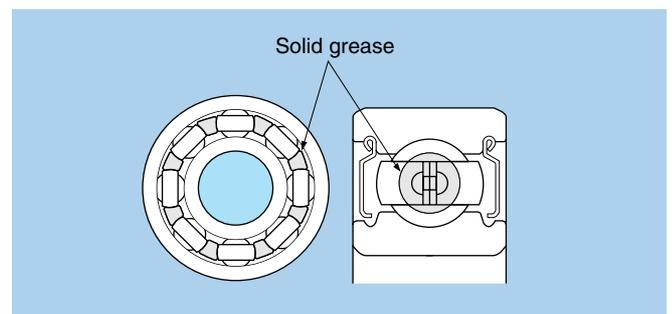

Fig. 11.3 Deep groove ball bearing with spot-pack solid grease (Z shield) (Standard for deep groove ball bearings)

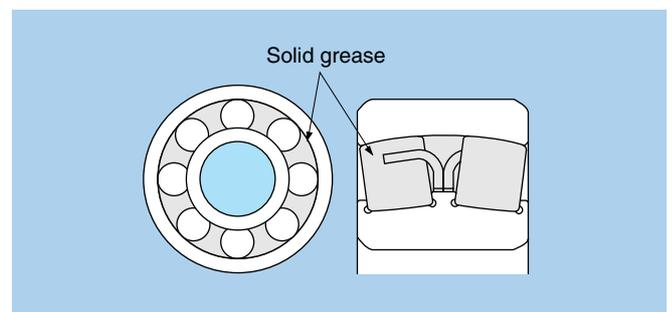

Fig. 11.4 Spherical roller bearing with full-pack solid grease (Standard for spherical roller bearings)

11.5 Oil lubrication

Oil lubrication is suitable for applications requiring that bearing-generated heat or heat applied to the bearing from other sources be carried away from the bearing and

dissipated to the outside. **Table 11.7** shows the main methods of oil lubrication.

Table 11.7 Oil lubrication methods

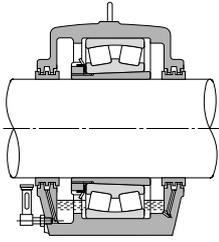
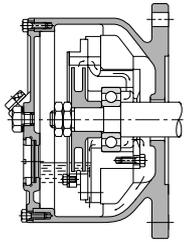
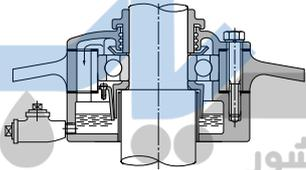
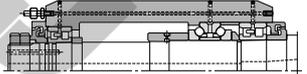
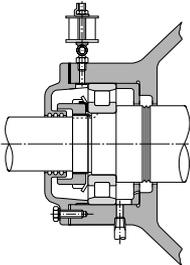
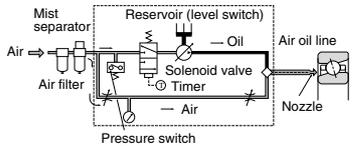
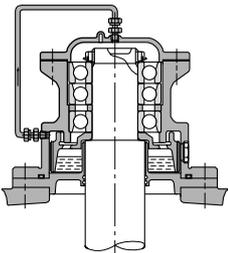
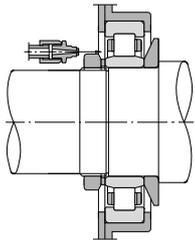
Lubrication method	Example	Lubrication method	Example
<p>(Oil bath lubrication)</p> <ul style="list-style-type: none"> Oil bath lubrication is the most generally used method of lubrication and is widely used for low to moderate rotation speed applications. For horizontal shaft applications, oil level should be maintained at approximately the center of the lowest rolling element, according to the oil gauge, when the bearing is at rest. For vertical shafts at low speeds, oil level should be maintained at 50-80% submergence of the rolling elements. 		<p>(Disc lubrication)</p> <ul style="list-style-type: none"> In this method, a partially submerged disc rotates and pulls oil up into a reservoir from which it then drains down through the bearing, lubricating it. 	
<p>(Oil spray lubrication)</p> <ul style="list-style-type: none"> In this method, an impeller or similar device mounted on the shaft draws up oil and sprays it onto the bearing. This method can be used at considerably high speeds. 		<p>(Oil mist lubrication)</p> <ul style="list-style-type: none"> Using pressurized air, lubricating oil is atomized before passing through the bearing. Due to the low lubricant resistance, this method is well suited to high speed applications. 	
<p>(Drip lubrication)</p> <ul style="list-style-type: none"> In this method, oil is collected above the bearing and allowed to drip down into the housing where it becomes a lubricating mist as it strikes the rolling elements. Another version allows only slight amounts of oil to pass through the bearing. Used at relatively high speeds for light to moderate load applications. In most cases, oil volume is a few drops per minute. 		<p>(Air-oil lubrication)</p> <ul style="list-style-type: none"> In this method, the required minimum amount of lubricating oil is measured and fed to each bearing at ideal intervals using compressed air. With fresh lubricating oil constantly being fed to the bearing, and with the cooling effect of the compressed air, bearing temperature rise can be minimized. Because the required oil quantity is infinitesimal, the working environment can be kept clean. Air-oil lubrication units are available from NTN. 	
<p>(Circulating lubrication)</p> <ul style="list-style-type: none"> Used for bearing cooling applications or for automatic oil supply systems in which the oil supply is centrally located. One of the advantages of this method is that oil cooling devices and filters to maintain oil purity can be installed within the system. In order for oil to thoroughly lubricate the bearing, oil inlets and outlets must be provided on opposite sides of the bearing. 		<p>(Oil jet lubrication)</p> <ul style="list-style-type: none"> This method lubricates by injecting oil under high pressure directly into the side of the bearing. This is a reliable system for high speed, high temperature or otherwise severe conditions. Used for lubricating the bearings in jet engines, gas turbines, and other high speed equipment. Under-race lubrication for machine tools is one example of this type of lubrication. 	

11.5.1 Selection of lubricating oil

Under normal operating conditions, **spindle oil, machine oil, turbine oil**, and other mineral oils are widely used for the lubrication of rolling bearings. However, for temperatures **above 150°C** or **below -30°C**, synthetic oils such as **diester oil, silicone oil, and fluorocarbon oil** are used.

For lubricating oils, viscosity is one of the most important properties and determines an oil's lubricating efficiency. If viscosity is too low, formation of the oil film will be insufficient, and damage will occur to the raceways of the bearing. If viscosity is too high, viscous resistance will also be great and result in temperature increases and friction loss. In general, for higher speed applications a lower viscosity oil should be used; for heavier load applications, a higher viscosity oil should be used.

In regard to operating temperature, **Table 11.8** lists the required oil viscosity for different types of rolling bearings. **Fig. 11.5** is an oil viscosity - operating temperature comparison chart for the purpose of selecting a lubrication oil with viscosity characteristics appropriate to an application.

Table 11.9 lists the selection standards for lubricating oil viscosity with reference to bearing operating conditions.

Table 11.8 Required lubricating oil viscosity for bearings

Bearing type	Kinematic viscosity mm ² /s
Ball bearings, Cylindrical roller bearings, Needle roller bearings	13
Spherical roller bearings, Tapered roller bearings, Needle roller thrust bearings	20
Self-aligning roller thrust bearings	30

11.5.2 Oil quantity

In forced oil lubrication systems, the heat radiated away by the housing and surrounding parts plus the heat carried away by the lubricating oil is approximately equal to the amount of heat generated by the bearing and other sources.

For general housing applications, the required quantity of oil can be found by formula (11.2).

$$Q = K \cdot q \dots\dots\dots (11.2)$$

where,

- Q: Quantity of oil for one bearing cm³/min.
- K: Allowable oil temperature rise factor (**Table 11.10**)
- q: Amount of lubrication determined by diagram cm³/min. (**Fig. 11.4**)

Because the amount of heat radiated will vary according to the type of housing, for actual operation it is advisable that the quantity of oil calculated by formula

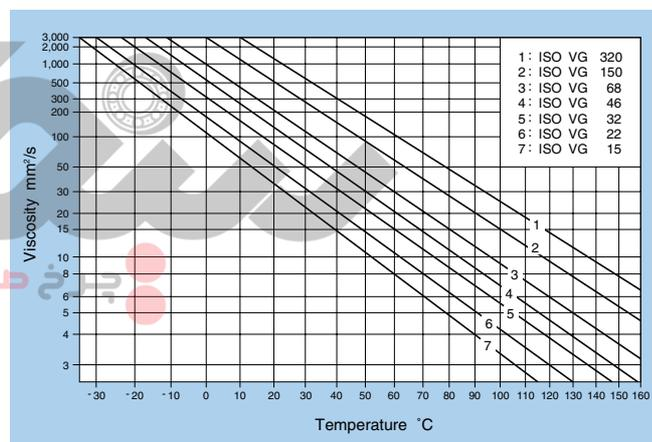

Fig. 11.5 Relation between lubricating oil viscosity and temperature

Table 11.9 Selection standards for lubricating oils (Reference)

Bearing operating temperature °C	dn-value	Lubricating oil ISO viscosity grade (VG)		Suitable bearing
		Normal load	Heavy load or shock load	
-30 ~ 0	Up to allowable rotational speed	22, 32	46	All types
0 ~ 60	Up to 15,000	46, 68	100	All types
	15,000 ~ 80,000	32, 46	68	All types
	80,000 ~ 150,000	22, 32	32	All types but thrust ball bearings
	150,000 ~ 500,000	10	22, 32	Single row radial ball bearings, cylindrical roller bearings
60 ~ 100	Up to 15,000	150	220	All types
	15,000 ~ 80,000	100	150	All types
	80,000 ~ 150,000	68	100, 150	All types but thrust ball bearings
	150,000 ~ 500,000	32	68	Single row radial ball bearings, cylindrical roller bearings
100 ~ 150	Up to allowable rotational speed	320		All types
0 ~ 60	Up to allowable rotational speed	46, 68		Self-aligning roller bearings
60 ~ 100	Up to allowable rotational speed	150		

Note 1: Applied when lubrication method is either oil bath or circulating lubrication.
 2: Please consult NTN Engineering in cases where operating conditions fall outside the range covered by this table.

Table 11.10 Factor K

Expelled oil temp minus supplied oil temp °C	K
10	1.5
15	1
20	0.75
25	0.6

(11.2) be multiplied by a factor of 1.5 or 2.0. Then, the amount of oil can be adjusted to correspond to actual operating conditions.

Furthermore, if it is assumed for calculation purposes that no heat is radiated by the housing, and that all bearing heat is removed by the oil, then the value for shaft diameter, $d = 0$.

(Example) For tapered roller bearing **30220U** mounted on a flywheel shaft with a radial load of 9.5 kN {969 kgf}, operating at 1,800 min⁻¹, what is the amount of lubricating oil 'Q' required to keep the bearing temperature rise below 15°C.

$d = 100 \text{ mm,}$

$dn = 100 \times 1,800 = 18 \times 10^4$

From **Fig. 11.6** $q = 180 \text{ cm}^3 / \text{min}$

Assume the bearing temperature is approximately equal to the expelled oil temperature, from **Table 11.10**, since $K = 1$

$Q = 1 \times 180 = 180 \text{ cm}^3 / \text{min}$

11.5.3 Relubrication intervals

The intervals at which lubricating oil should be changed varies depending upon operating conditions, oil quantity, and type of oil used. In general, for oil bath lubrication where the operating temperature is 50°C or less, oil should be replaced once a year. When the operating temperature is between 80°C – 100°C, oil should be replaced at least every three months. For important equipment, it is advisable that lubricating efficiency and oil purity deterioration be checked regularly to determine when oil replacement is necessary.

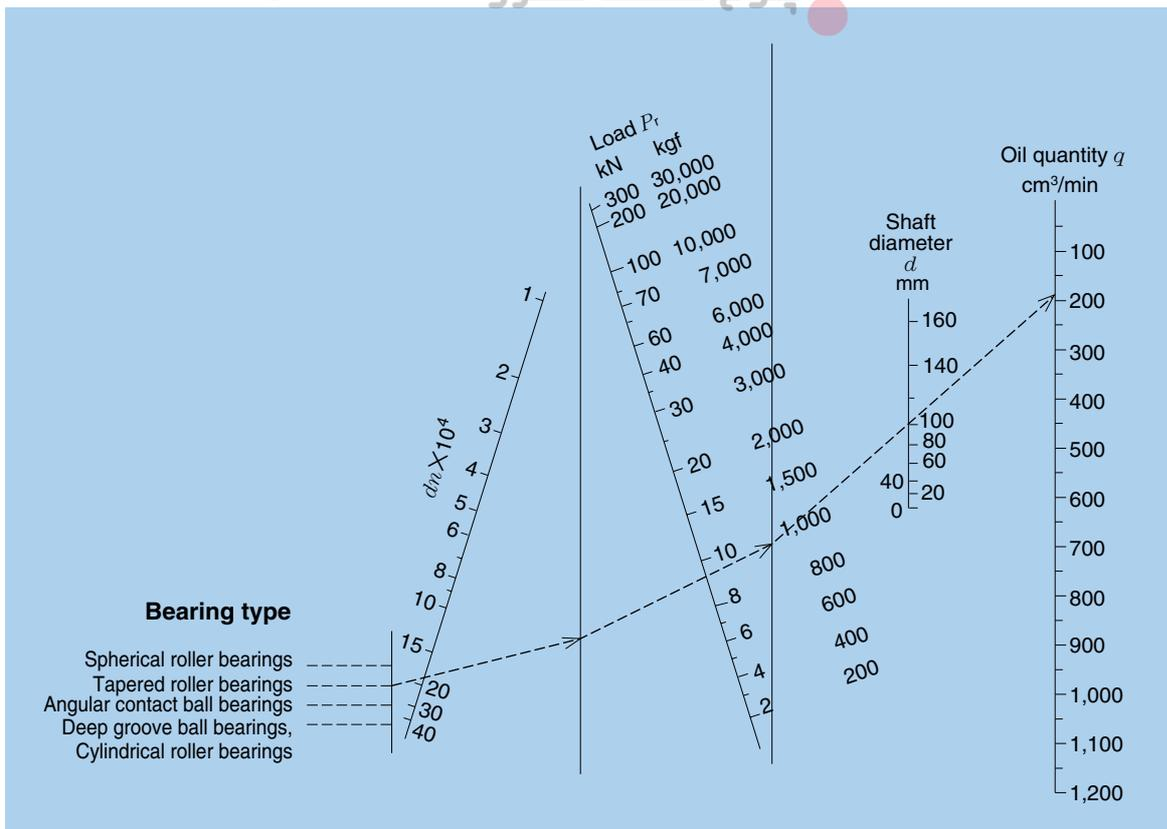

Fig. 11.6 Oil quantity guidelines

12. External bearing sealing devices

External seals have two main functions: to prevent lubricating oil from leaking out, and, to prevent dust, water, and other contaminants from entering the bearing. When selecting a seal, the following factors need to be taken into consideration: the type of lubricant (oil or grease), seal peripheral speed, shaft fitting errors, space limitations, seal friction and resultant heat increase, and cost.

Sealing devices for rolling bearings fall into two main classifications: non-contact seals and contact seals.

- **Non-contact seals:** Non-contact seals utilize a small clearance between the shaft and the housing cover. Therefore friction is negligible, making them suitable for high speed applications.

In order to improve sealing capability, clearance spaces are often filled with lubricant.

- **Contact seals:** A contact seal is a seal whereby a

formed synthetic rubber lip on a steel plate is pressed against the shaft. Contact seals are generally far superior to non-contact seals in sealing efficiency, although their friction torque and temperature rise coefficients are higher. Furthermore, because the lip portion of a contact seal slides while in contact with the shaft, the allowable seal peripheral speed varies depending on seal type.

Lubrication is required in the place where the seal lip makes contact with the shaft. Ordinary bearing lubricant can also be used for this purpose.

The following chart lists the special characteristics of seals and other points to be considered when choosing an appropriate seal.

Type	Seal construction	Name	Seal characteristics and selection considerations																	
Non-contact seals		Clearance seal	This is an extremely simple seal design with a small radial clearance.																	
		Oil groove seal (oil grooves on housing side)	Several concentric oil grooves are provided on the housing inner diameter to greatly improve the sealing effect. When the grooves are filled with lubricant, the intrusion of contaminants from the outside is prevented.																	
		Oil groove seal (oil grooves on shaft and housing side)	Oil grooves are provided on both the shaft outer diameter and housing inner diameter for a seal with even greater sealing efficiency.																	
		Axial labyrinth seal	This seal has a labyrinth passageway on the axial side of the housing.																	
		Radial labyrinth seal	A labyrinth passageway is affixed to the radial side of the housing. For use with split housings. This offers better sealing efficiency than axial labyrinth seals.																	
		Aligning labyrinth seal	The seal's labyrinth passageway is slanted and has sufficient clearance to prevent contact between the housing projections and the shaft even as the shaft realigns.																	
			<p>Cautionary points regarding selection</p> <ul style="list-style-type: none"> • In order to improve sealing efficiency, clearances between the shaft and housing should be minimized. However, care should be taken to confirm shaft/bearing rigidity and other factors to avoid direct shaft-housing contact during operation. <p>Oil groove clearance (reference)</p> <table border="1"> <thead> <tr> <th>Shaft diameter mm</th> <th>Clearance mm</th> </tr> </thead> <tbody> <tr> <td>Up to 50</td> <td>0.2~0.4</td> </tr> <tr> <td>50 or above</td> <td>0.5~1.0</td> </tr> </tbody> </table> <ul style="list-style-type: none"> • Oil groove width, depth (reference) width : 2~5 mm depth : 4~5 mm • Three or more oil grooves should be provided. • Sealing efficiency can be further improved by filling the oil groove portion with grease of which the consistency grade is 150 to 200. • Grease is generally used as the lubricant for labyrinth seals, and, except in low speed applications, is commonly used together with other sealing devices. <p>Cautionary points regarding selection</p> <ul style="list-style-type: none"> • In order to improve sealing efficiency, labyrinth passageway clearances should be minimized. However, care should be taken to confirm shaft/bearing rigidity, fit, internal clearances and other factors to avoid direct contact between labyrinth projections during operation. <p>Labyrinth clearance (reference)</p> <table border="1"> <thead> <tr> <th rowspan="2">Shaft diameter mm</th> <th colspan="2">Clearance mm</th> </tr> <tr> <th>Radial direction</th> <th>Axial direction</th> </tr> </thead> <tbody> <tr> <td>—~ 50</td> <td>0.2~0.4</td> <td>1.0~2.0</td> </tr> <tr> <td>50~200</td> <td>0.5~1.0</td> <td>3.0~5.0</td> </tr> </tbody> </table> <ul style="list-style-type: none"> • Sealing efficiency can be further improved by filling the labyrinth passageway with grease of which the consistency grade is 150 to 200. • Labyrinth seals are suitable for high speed applications. 	Shaft diameter mm	Clearance mm	Up to 50	0.2~0.4	50 or above	0.5~1.0	Shaft diameter mm	Clearance mm		Radial direction	Axial direction	—~ 50	0.2~0.4	1.0~2.0	50~200	0.5~1.0	3.0~5.0
Shaft diameter mm	Clearance mm																			
Up to 50	0.2~0.4																			
50 or above	0.5~1.0																			
Shaft diameter mm	Clearance mm																			
	Radial direction	Axial direction																		
—~ 50	0.2~0.4	1.0~2.0																		
50~200	0.5~1.0	3.0~5.0																		

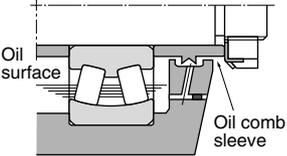
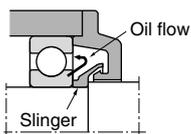
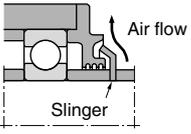
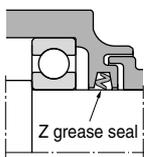
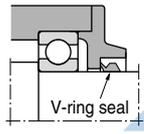
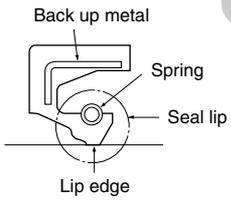
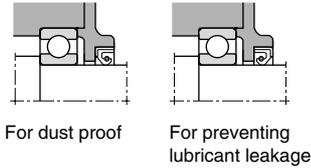
Type	Seal construction	Name	Seal characteristics and selection considerations																					
Non-contact seals		Oil comb sleeve	In this design, lubricating oil that makes its way out of the housing along the shaft is thrown off by projections on the oil comb sleeve and recirculated.																					
		Slinger provided in the housing	Seal type whereby a slinger is provided in the housing that prevents lubricant from leaking by centrifugal force produced by rotation.																					
		Slinger provided outside the housing	By mounting a slinger on the outside of the housing, centrifugal force helps to prevent dust and other solid contaminants from entering.																					
Contact seals		Z grease seal	In cross section resembling the letter "Z," this seal's empty spaces are filled with grease. The seal is commonly used with a plumber block (bearing housing).																					
		V-ring seal	This design enhances sealing efficiency with a lip that seals from the axial direction. With the aid of centrifugal force, this seal also offers effective protection against dust, water, and other contaminants entering the bearing. Can be used for both oil and grease lubrication. At seal peripheral speeds in excess of 12 m/s, seal ring fit is lost due to centrifugal force, and a clamping band is necessary to hold it in place.																					
		Oil seal	Oil seals are widely used, and their shapes and dimensions are standardized under JIS B 2402. In this design, a ring-shaped spring is installed in the lip section. As a result, optimal contact pressure is exerted between the lip edge and shaft surface, and sealing efficiency is good. When the bearing and oil seal are in close proximity, the internal clearance of the bearing may be reduced by heat produced by the oil seal. In addition to considering the heat generated by contact seals at various peripheral speeds, internal bearing clearances must also be selected with caution. Depending on its orientation, the seal may function to prevent lubricant from leaking out or foreign matter from getting in.																					
																								
			<p>Cautionary points regarding selection</p> <ul style="list-style-type: none"> Seal type whereby a slinger that utilizes centrifugal force is provided on the rotating shaft. If mounted on the inside of the housing, the slinger should function to seal in lubricant by centrifugal force produced by rotation. If mounted on the outside of the housing, the slinger should function to seal out foreign matter by fan effect produced by rotation. These seal types are commonly employed together with other sealing devices. 																					
			<p>Cautionary points regarding selection</p> <p>Shaft surface roughness (reference)</p> <table border="1"> <thead> <tr> <th rowspan="2">Peripheral speed m/s</th> <th colspan="2">Surface roughness</th> </tr> <tr> <th>Ra</th> <th>Rmax</th> </tr> </thead> <tbody> <tr> <td>~ 5</td> <td>0.8a</td> <td>3.2s</td> </tr> <tr> <td>5~10</td> <td>0.4a</td> <td>1.6s</td> </tr> <tr> <td>10~</td> <td>0.2a</td> <td>0.8s</td> </tr> </tbody> </table> <p>Shaft material (reference)</p> <table border="1"> <tbody> <tr> <td>Material</td> <td>Machine structural carbon steel, Low carbon alloy steel, Stainless steel</td> </tr> <tr> <td>Surface hardness</td> <td>HRC 40 or higher necessary HRC 55 or higher advisable</td> </tr> <tr> <td>Processing method</td> <td>Final grinding without repeat (moving), or buffed after hard chrome plating</td> </tr> </tbody> </table>	Peripheral speed m/s	Surface roughness		Ra	Rmax	~ 5	0.8a	3.2s	5~10	0.4a	1.6s	10~	0.2a	0.8s	Material	Machine structural carbon steel, Low carbon alloy steel, Stainless steel	Surface hardness	HRC 40 or higher necessary HRC 55 or higher advisable	Processing method	Final grinding without repeat (moving), or buffed after hard chrome plating	
Peripheral speed m/s	Surface roughness																							
	Ra	Rmax																						
~ 5	0.8a	3.2s																						
5~10	0.4a	1.6s																						
10~	0.2a	0.8s																						
Material	Machine structural carbon steel, Low carbon alloy steel, Stainless steel																							
Surface hardness	HRC 40 or higher necessary HRC 55 or higher advisable																							
Processing method	Final grinding without repeat (moving), or buffed after hard chrome plating																							
			<p>Allowable speed/temperature according to seal type/material (reference)</p> <table border="1"> <thead> <tr> <th>Seal type/material</th> <th>Allowable peripheral speed m/s ($v(m/s) = \frac{\pi \times d(mm) \times n(r/min)}{60,000}$)</th> <th>Allowable temp °C</th> </tr> </thead> <tbody> <tr> <td>Nitrile rubber</td> <td>16 or less</td> <td>-25 ~ +120</td> </tr> <tr> <td rowspan="2">Oil seals</td> <td>Acrylic rubber</td> <td>26 or less</td> <td>-15 ~ +150</td> </tr> <tr> <td>Fluorinated rubber</td> <td>32 or less</td> <td>-30 ~ +200</td> </tr> <tr> <td>Z-seal</td> <td>Nitrile rubber</td> <td>6 or less</td> <td>-25 ~ +120</td> </tr> <tr> <td>V-ring</td> <td>Nitrile rubber</td> <td>40 or less</td> <td>-25 ~ +120</td> </tr> </tbody> </table>	Seal type/material	Allowable peripheral speed m/s ($v(m/s) = \frac{\pi \times d(mm) \times n(r/min)}{60,000}$)	Allowable temp °C	Nitrile rubber	16 or less	-25 ~ +120	Oil seals	Acrylic rubber	26 or less	-15 ~ +150	Fluorinated rubber	32 or less	-30 ~ +200	Z-seal	Nitrile rubber	6 or less	-25 ~ +120	V-ring	Nitrile rubber	40 or less	-25 ~ +120
Seal type/material	Allowable peripheral speed m/s ($v(m/s) = \frac{\pi \times d(mm) \times n(r/min)}{60,000}$)	Allowable temp °C																						
Nitrile rubber	16 or less	-25 ~ +120																						
Oil seals	Acrylic rubber	26 or less	-15 ~ +150																					
	Fluorinated rubber	32 or less	-30 ~ +200																					
Z-seal	Nitrile rubber	6 or less	-25 ~ +120																					
V-ring	Nitrile rubber	40 or less	-25 ~ +120																					

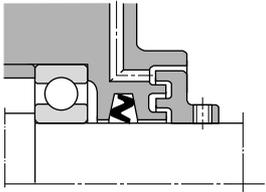
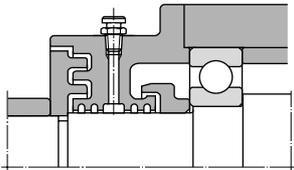
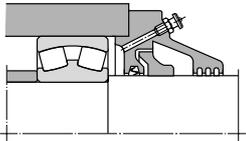
Type	Seal construction	Name	Seal characteristics and selection considerations
Combination seals		Z-seal + Labyrinth seal	This is an example of an axial labyrinth seal which has been combined with a Z-seal to increase its sealing efficiency. The axial labyrinth seal is affixed to the shaft with a setting bolt or other method. In the diagram on the left, both the direction of the Z-seal and the labyrinth seal are oriented to keep dust and other contaminants out of the bearing. Because a Z-seal has been incorporated, the allowable peripheral speed should not exceed 6 m/s.
		Labyrinth seal + Oil groove seal + Slinger	This is an example of a combination of three different non-contact seals. It has the advantage of preventing both lubricant leakage from inside the bearing and infiltration of dust and other contaminants from the outside. It is widely used on mining equipment and as a sealing system with plummer blocks in extremely dusty application conditions.
		Oil groove seal + Slinger + Z-seal	This is an example where an oil groove seal and slinger have been combined with a Z-seal to increase its sealing efficiency. In the diagram on the left, all three seals have been oriented to keep dust and other contaminants out of the bearing. The combination is widely used on mining equipment and as a sealing system with plummer blocks in extremely dusty application conditions.



13. Bearing Materials

13.1 Raceway and rolling element materials

While the contact surfaces of a bearing's raceways and rolling elements are subjected to repeated heavy stress, they still must maintain high precision and rotational accuracy. To accomplish this, the raceways and rolling elements must be made of a material that has high hardness, is resistant to rolling fatigue, is wear resistant, and has good dimensional stability. The most common cause of fatigue in bearings is the inclusion of non-metallic impurities in the steel. Non-metallic inclusion includes hard oxides that can cause fatigue crack. Clean steel with minimal non-metallic inclusion must therefore be used.

For all NTN bearings, steel low in oxygen content and non-metallic impurities, then refined by a vacuum degassing process as well as outside hearth smelting, is used. For bearings requiring especially high reliability and long life, steels of even higher in purity, such as vacuum melted steel (VIM, VAR) and electro-slag melted steel (ESR), are used.

1) High/mid carbon alloy steel

In general, steel varieties which can be hardened not just on the surface but also deep hardened by the so-called "through hardening method" are used for the raceways and rolling elements of bearings. Foremost among these is high carbon chromium bearing steel, which is widely used. For large type bearings and bearings with large cross sectional dimensions, induction hardened bearing steel incorporating manganese or molybdenum is used. Also in use is mid-carbon chromium steel incorporating silicone and manganese, which gives it hardening properties comparable to high carbon chromium steel.

Table 13.1 gives chemical composition of representative high carbon chrome bearing steel that meets JIS standards. SUJ2 is frequently used. SUJ3 with enhanced hardening characteristics containing a large quantity of Mn is used for large bearings. SUJ5 is SUJ3 to which Mo has been added to further enhance hardening characteristics, and is used for oversized bearings or bearings with thick walls.

The chemical composition of SUJ2 is equivalent to AISI 52100 (US) and DIN 100Cr6 (Germany).

2) Case hardened (carburizing) steel

Carburizing hardens the steel from the surface to the proper depth, forming a relatively soft core. This provides hardness and toughness, making the material suitable for impact loads. NTN uses case hardened steel for almost all of its tapered roller bearings. In terms of case hardened steel for NTN's other bearings, chromium steel and chrome molybdenum steel are used for small to medium sized bearings, and nickel chrome molybdenum steel is used for large sized bearings.

Table 13.2 gives the chemical composition of representative JIS case hardened steel.

3) Heat resistant bearing steel

When bearings made of ordinary high carbon chromium

steel which have undergone standard heat treatment are used at temperatures above 120°C for long durations, unacceptably large dimensional changes can occur. For this reason, a dimension stabilizing treatment (TS treatment) has been devised for very high temperature applications. This treatment however reduces hardness of the material, thereby reducing rolling fatigue life. (See item 3.3.2 on page A-18.)

For standard high temperature bearings used at temperatures from 150°C – 200°C, the addition of silicone to the steel improves heat resistance and results in a bearing with excellent rolling fatigue life with minimal dimensional change or softening at high temperatures.

A variety of heat resistant steels are also incorporated in bearings to minimize softening and dimensional changes when used at high temperatures. Two of these are high speed molybdenum steel and high speed tungsten steel. For bearings requiring heat resistance in high speed applications, there is also heat resistant case hardening molybdenum steel. (refer to **Table 13.3**)

4) Corrosion resistant bearing steel

For applications requiring high corrosion resistance, stainless steel is used. To achieve this corrosion resistance a large proportion of the alloying element chrome is added to martensite stainless steel. (**Table 13.4**)

5) Induction hardened steel

Besides the use of surface hardening steel, induction hardening is also utilized for bearing raceway surfaces, and for this purpose mid-carbon steel is used for its lower carbon content instead of through hardened steel. For induction hardening of the deep layers required for larger bearings and bearings with large surface dimensions, mid-carbon steel is fortified with chrome and molybdenum.

6) Other bearing materials

For ultra high speed applications and applications requiring very high level corrosion resistance, ceramic bearing materials such as Si₃N₄ are also available.

13.2 Cage materials

Bearing cage materials must have the strength to withstand rotational vibrations and shock loads. These materials must also have a low friction coefficient, be light weight, and be able to withstand bearing operation temperatures.

For small and medium sized bearings, pressed cages of cold or hot rolled steel with a low carbon content of approx. 0.1% are used. However, depending on the application, austenitic stainless steel is also used.

Machined cages are generally used for large bearings. Carbon steel for machine structures or high-strength cast brass is frequently used for the cages, but other materials such as aluminum alloy are also used.

Tables 13.5 and 13.6 give the chemical composition for these representative cage materials.

Besides high-strength brass, medium carbon nickel, chrome and molybdenum that has been hardened and tempered at high temperatures are also used for bearings used in aircraft. The materials are often plated with silver to enhance lubrication characteristics.

High polymer materials that can be injection molded are

also widely used for cages. Polyamide resin reinforced with glass fibers is generally used. Cages made of high-polymer materials are lightweight and corrosion resistant. They also have superior damping and characteristics and lubrication performance. **Heat resistant polyimide resins now enable the production of cages that perform well in applications ranging between -40°C – 120°C.** However, they are not recommended for use at temperatures exceeding 120°C.

Table 13.1 Chemical composition of representative high carbon chrome bearing steels

Standard	Symbol	Chemical composition (%)							Remarks
		C	Si	Mn	P	S	Cr	Mo	
JIS G 4805	SUJ2	0.95~1.10	0.15~0.35	Max. 0.50	Max. 0.025	Max. 0.025	1.30~1.60	Max. 0.08	
	SUJ3	0.95~1.10	0.40~0.70	0.90~1.15	Max. 0.025	Max. 0.025	0.90~1.20	Max. 0.08	
	SUJ5	0.95~1.10	0.40~0.70	0.90~1.15	Max. 0.025	Max. 0.025	0.90~1.20	0.10~0.25	
ASTM A295	52100	0.98~1.10	0.15~0.35	0.25~0.45	Max. 0.025	Max. 0.025	1.30~1.60	Max. 0.10	SUJ2 equivalent
ASTM A485	Grade 1	0.90~1.05	0.45~0.75	0.95~1.25	Max. 0.025	Max. 0.025	0.90~1.20	Max. 0.10	SUJ3 equivalent
	Grade 3	0.95~1.10	0.15~0.35	0.65~0.90	Max. 0.025	Max. 0.025	1.10~1.50	0.20~0.30	SUJ5 equivalent

Table 13.2 Chemical composition of representative case hardened steel (carburizing steel)

Standard	Symbol	Chemical composition (%)							
		C	Si	Mn	P	S	Ni	Cr	Mo
JIS G 4104	SCr420	0.18~0.23	0.15~0.35	0.60~0.85	Max. 0.030	Max. 0.030	—	0.90~1.20	—
JIS G 4105	SCM420	0.18~0.23	0.15~0.35	0.60~0.85	Max. 0.030	Max. 0.030	—	0.90~1.20	0.15~0.30
JIS G 4103	SNM220	0.17~0.23	0.15~0.35	0.60~0.90	Max. 0.030	Max. 0.030	0.40~0.70	0.40~0.65	0.15~0.30
	SNM420	0.17~0.23	0.15~0.35	0.40~0.70	Max. 0.030	Max. 0.030	1.60~2.00	0.40~0.65	0.15~0.30
	SNM815	0.12~0.18	0.15~0.35	0.30~0.60	Max. 0.030	Max. 0.030	4.00~4.50	0.70~1.00	0.15~0.30
ASTM A534	5120	0.17~0.22	0.15~0.35	0.70~0.90	Max. 0.030	Max. 0.040	—	0.70~0.90	—
	4118	0.18~0.23	0.15~0.35	0.70~0.90	Max. 0.030	Max. 0.040	—	0.40~0.60	0.08~0.15
	8620	0.18~0.23	0.15~0.35	0.70~0.90	Max. 0.030	Max. 0.040	0.40~0.70	0.40~0.60	0.15~0.25
	4320	0.17~0.22	0.15~0.35	0.45~0.65	Max. 0.030	Max. 0.040	1.65~2.00	0.40~0.60	0.20~0.30
	9310	0.08~0.13	0.15~0.35	0.45~0.65	Max. 0.025	Max. 0.025	3.00~3.50	1.00~1.40	0.08~0.15

Table 13.3 Chemical composition of high-speed steel

Standard	Symbol	Chemical composition (%)											
		C	Si	Mn	P	S	Cr	Mo	V	Ni	Cu	Co	W
AMS	6491 (M50)	0.77~0.85	Max. 0.25	Max. 0.35	Max. 0.015	Max. 0.015	3.75~4.25	4.00~4.50	0.90~1.10	Max. 0.15	Max. 0.10	Max. 0.25	Max. 0.25
	5626	0.65~0.80	0.20~0.40	0.20~0.40	Max. 0.030	Max. 0.030	3.75~4.50	Max. 1.00	0.90~1.30	—	—	—	17.25~18.25
	2315 (M50NiL)	0.11~0.15	0.10~0.25	0.15~0.35	Max. 0.015	Max. 0.010	4.00~4.25	4.00~4.50	1.13~1.33	3.20~3.60	Max. 0.10	Max. 0.25	Max. 0.25

Table 13.4 Chemical composition of stainless steel

Standard	Symbol	Chemical composition (%)						
		C	Si	Mn	P	S	Cr	Mo
JIS G 4303	SUS440C	0.95~1.20	Max. 1.00	Max. 1.00	Max. 0.040	Max. 0.030	16.00~18.00	Max. 0.75
AISI	440C	0.95~1.20	Max. 1.00	Max. 1.00	Max. 0.040	Max. 0.030	16.00~18.00	Max. 0.75

Table 13.5 Chemical composition of steel plate for pressed cages and carbon steel for machined cages

	Standard	Symbol	Chemical composition (%)						
			C	Si	Mn	P	S	Ni	Cr
Pressed retainer	JIS G 3141	SPCC	—	—	—	—	—	—	—
	JIS G 3131	SPHC	—	—	—	Max. 0.050	Max. 0.050	—	—
	BAS 361	SPB2	0.13~0.20	Max. 0.04	0.25~0.60	Max. 0.030	Max. 0.030	—	—
	JIS G 4305	SUS304	Max. 0.08	Max. 1.00	Max. 2.00	Max. 0.045	Max. 0.030	8.00~10.50	18.00~20.00
Machined retainer	JIS G 4051	S25C	0.22~0.28	0.15~0.35	0.30~0.60	Max. 0.030	Max. 0.035	—	—

Table 13.6 Chemical composition of high-strength cast brass for machined cages

Standard	Symbol	Chemical composition (%)							Impurities	
		Cu	Zn	Mn	Fe	Al	Sn	Ni	Pb	Si
JIS H 5120	CAC301	55.0~60.0	33.0~42.0	0.1~1.5	0.5~1.5	0.5~1.5	Max. 1.0	Max. 1.0	Max. 0.4	Max. 0.1

14. Shaft and Housing Design

Depending upon the design of a shaft or housing, the shaft may be influenced by an unbalanced load or other factors which can then cause large fluctuations in bearing efficiency. For this reason, it is necessary to pay attention to the following when designing shaft and housing:

- 1) Bearing arrangement selection; most effective fixing method for bearing arrangement
- 2) Selection of shoulder height and fillet radius of housing and shaft.
- 3) Shape precision and dimensions of fitting; area runout tolerance of shoulder.
- 4) Machining precision and mounting error of housing and shaft suitable for allowable alignment angle and inclination of bearing.

14.1 Fixing of bearings

When fixing a bearing in position on a shaft or housing, there are many instances where the interference fit alone is not enough to hold the bearing in place. Bearings must be fixed in place by various methods so that they do not move axially when placed under load.

Moreover, **even bearings which are not subjected to axial loads (such as cylindrical roller bearings, etc.), must be fixed in place axially because of the potential for ring displacement due to shaft deflection by moment load which may cause damage.**

Table 14.1 shows general bearing fixing methods, and **Table 14.2** shows fixing methods for bearings with tapered bores.

Table 14.1 General bearing fixing methods

Inner ring clamp	Outer ring clamp	Snap ring
		
<p>The most common method of fixing bearings in place is to use clamping nuts or bolts to hold the bearing or housing abutment against the ring end face.</p>		<p>Use of snap rings regulated under JIS B 2804, B 2805, and B 2806, makes construction very simple. However, interference with chamfers, bearing installation dimensions, and other related specifications must be considered carefully.</p> <p>Snap rings are not suitable for applications requiring high accuracy and where the snap ring receives large axial loads.</p>

Table 14.2 Fixing methods for bearings with tapered bores

Adapter sleeve mounting	Withdrawal sleeve mounting	Split ring mounting
		
<p>When installing bearings on cylindrical shafts, adapter sleeves or withdrawal sleeves can be used to fix bearings in place axially.</p> <p>The adapter sleeve is fastened in place by frictional force between the shaft and inner diameter of the sleeve.</p>		<p>For installation of tapered bore bearings directly on tapered shafts, the bearing is held in place by a split ring inserted into a groove on the shaft, and is fixed in place by a split ring nut or screw.</p>

14.2 Bearing fitting dimensions

14.2.1 Abutment height and fillet radius

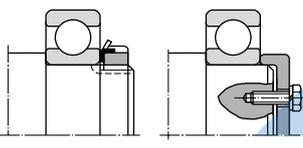
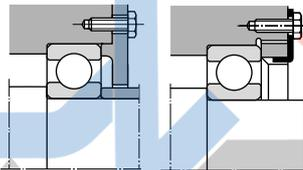
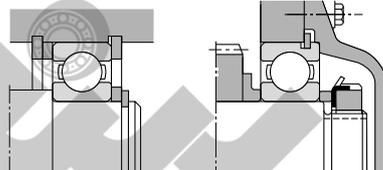
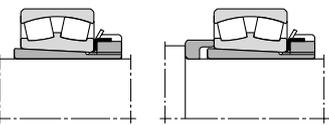
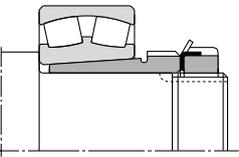
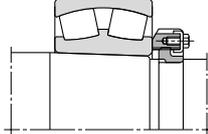
The shaft and housing abutment height (h) should be larger than the bearings' maximum allowable chamfer dimensions ($r_{s \max}$), and the abutment should be designed so that it directly contacts the flat part of the bearing end face. The fillet radius (r_a) must be smaller than the bearing's minimum allowable chamfer dimension ($r_{s \min}$) so that it does not interfere with bearing seating. **Table 14.3** lists abutment height (h) and fillet radius (r_a).

For bearings to be applied to very large axial loads as well, shaft abutments (h) should be higher than the values in the table.

14.2.2 For spacer and ground undercut

In cases where a fillet radius ($r_{a \max}$) larger than the bearing chamfer dimension is required to strengthen the shaft or to relieve stress concentration (**Fig. 14.1a**), or where the shaft abutment height is too low to afford adequate contact surface with the bearing (**Fig. 14.1b**), spacers may be used effectively.

Relief dimensions for ground shaft and housing fitting surfaces are given in **Table 14.4**.

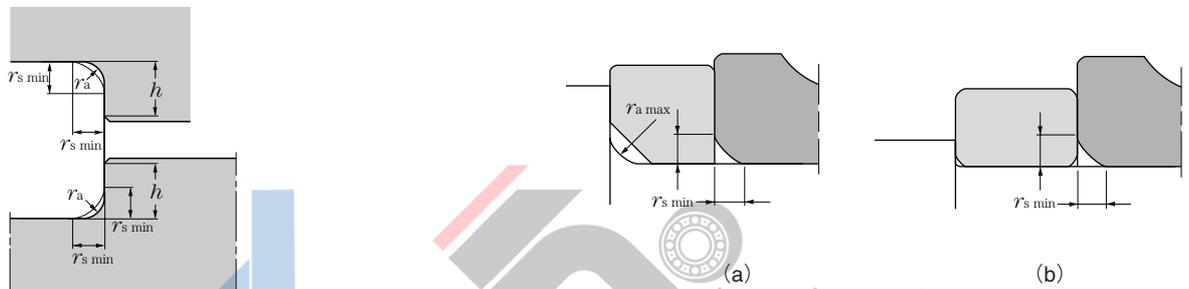

Fig. 14.1 Bearing mounting with spacer

Table 14.3 Fillet radius and abutment height Unit mm

$r_{s \min}$	$r_{as \max}$	h (min)	
		Normal use ¹	Special use ²
0.05	0.05	0.3	
0.08	0.08	0.3	
0.1	0.1	0.4	
0.15	0.15	0.6	
0.2	0.2	0.8	
0.3	0.3	1.25	1
0.6	0.6	2.25	2
1	1	2.75	2.5
1.1	1	3.5	3.25
1.5	1.5	4.25	4
2	2	5	4.5
2.1	2	6	5.5
2.5	2	6	5.5
3	2.5	7	6.5
4	3	9	8
5	4	11	10
6	5	14	12
7.5	6	18	16
9.5	8	22	20
12	10	27	24
15	12	32	29
19	15	42	38

- 1 If bearing supports large axial load, the height of the shoulder must exceed the value given here.
- 2 Used when axial load is light. These values are not suitable for tapered roller bearings, angular ball bearings and spherical roller bearings.

Note: $r_{as \max}$ maximum allowable fillet radius.

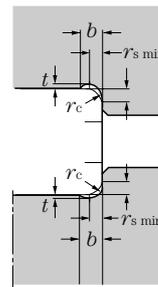

Table 14.4 Relief dimensions for ground shaft

$r_{s \min}$	Relief dimensions		
	b	t	r_c
1	2	0.2	1.3
1.1	2.4	0.3	1.5
1.5	3.2	0.4	2
2	4	0.5	2.5
2.1	4	0.5	2.5
2.5	4	0.5	2.5
3	4.7	0.5	3
4	5.9	0.5	4
5	7.4	0.6	5
6	8.6	0.6	6
7.5	10	0.6	7

14.2.3 Thrust bearings and fitting dimensions

For thrust bearings, it is necessary to make the raceway washer back face sufficiently broad in relation to load and rigidity, and fitting dimensions from the dimension tables should be adopted. (Figs. 14.2 and 14.3)

For this reason, shaft and abutment heights will be larger than for radial bearings. (Refer to dimension tables for all thrust bearing fitting dimensions.)

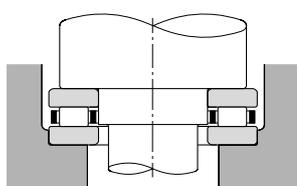

Fig. 14.2

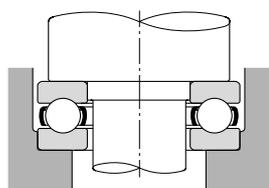

Fig. 14.3

14.3 Shaft and housing accuracy

Table 14.5 shows the accuracies for shaft and housing fitting surface dimensions and configurations, as well as fitting surface roughness and abutment squareness for normal operating conditions.

Table 14.5 Shaft and housing accuracy

Characteristics		Shaft	Housing
Dimensional accuracy		IT6 (IT5)	IT7 (IT5)
Roundness (max.) Cylindricity		IT3	IT4
Abutment squareness		IT3	IT3
Fitting surface roughness	Small size bearings	0.8a	1.6a
	Mid-large size bearings	1.6a	3.2a

Note: For precision bearings (P4, P5 accuracy), it is necessary to increase the circularity and cylindricity accuracies in this table by approximately 50%. For more specific information, please consult the NTN precision rolling bearing catalog.

14.4 Allowable bearing misalignment

A certain amount of misalignment of a bearing's inner and outer rings occurs as a result of shaft flexure, shaft or housing finishing irregularities, and minor installation error. In situations where the degree of misalignment is liable to be relatively large, self-aligning ball bearings, spherical roller bearings, bearing units and other bearings with aligning properties are advisable. Although allowable misalignment will vary according to bearing type, load conditions, internal clearances, etc., Table 14.6 lists some general misalignment standards for normal applications. In order to avoid shorter bearing life and cage failure, it is necessary to maintain levels of misalignment below these standard levels.

Table 14.6 Bearing type and allowable misalignment/alignment allowance

Allowable misalignment	
Deep groove ball bearings	1/1,000~1/300
Angular contact ball bearings	
Single row	1/1,000
Multi row	1/10,000
back to back arrangement	1/10,000
Face to face arrangement	1/1,000
Cylindrical roller bearings	
Bearing series 2, 3, 4	1/1,000
Bearing series 22, 23, 49, 30	1/2,000
Tapered roller bearings	
Single row/back to back arrangement	1/2,000
Face-to-face arrangement	1/1,000
Needle roller bearings	1/2,000
Thrust bearings (excluding self-aligning roller thrust bearings)	1/10,000
Alignment allowance	
Self-aligning ball bearings	1/20~1/15
Spherical roller bearings	1/50~1/30
Self-aligning roller thrust bearings	1/30
Ball bearing units	
Without cover	1/30
With cover	1/50

15. Bearing Handling

Bearings are precision parts and, in order to preserve their accuracy and reliability, care must be exercised in their handling.

In particular, bearing cleanliness must be maintained, sharp impacts avoided, and rust prevented.

15.1 Bearing storage

Most rolling bearings are coated with a rust prevent oil before being packed and shipped, and they should be stored at room temperature with a relative humidity of less than 60%.

15.2 Installation



When bearings are being installed on shafts or in housings, the bearing rings should never be struck directly with a hammer or a drift, as shown in **Fig. 15.1**, because damage to the bearing may result. **Any force applied to the bearing should always be evenly distributed over the entire bearing ring face.** Also, when fitting both rings simultaneously, applying pressure to one ring only, as shown in **Fig. 15.2**, should be avoided because indentations in the raceway surface may be caused by the rolling elements, or other internal damage may result.

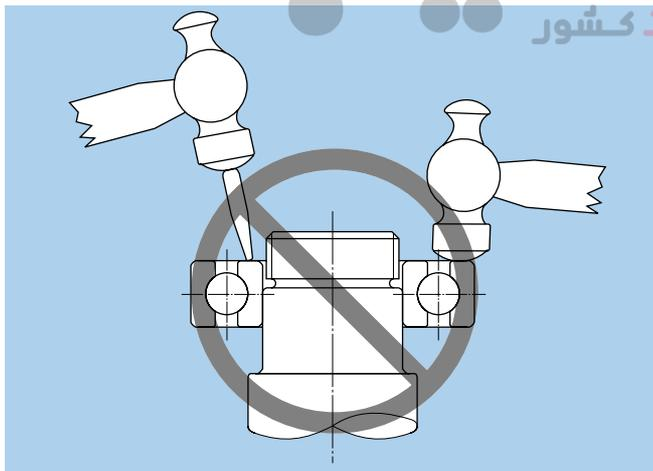

Fig. 15.1

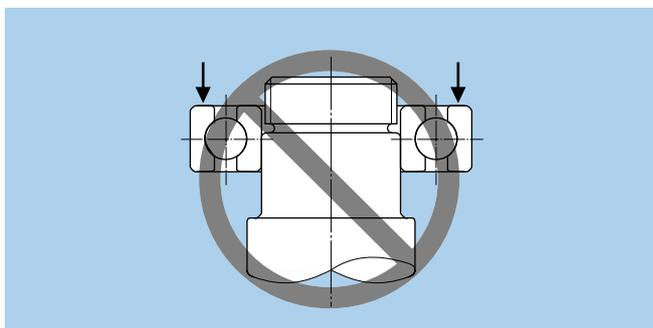

Fig. 15.2

15.2.1 Installation preparations

Bearings should be fitted in a clean, dry work area. Especially for small and miniature bearings, a "clean room" should be provided as any contamination particles in the bearing will greatly affect bearing efficiency.

All dirt, burrs or metal filings must be removed from the shaft, housing and tools used for mounting the bearings. Shaft and housing fitting surfaces should also be checked for roughness, dimensional and design accuracy, and to ensure that they are within allowable tolerance limits.

Bearings should not be unwrapped until just prior to installation. Normally, bearings to be used with grease lubricant can be installed as is, without removing the rust prevent oil. However, for bearings which will use oil lubricant, or in cases where mixing the grease and rust prevent oil would result in loss of lubrication efficiency, the rust prevent oil should be removed by washing with benzene or petroleum solvent and dried before installation. Bearings should also be washed and dried before installation if the package has been damaged or there are other chances that the bearings have been contaminated. **Double shielded bearings and sealed bearings should never be washed.**

15.2.2 Installing cylindrical bore bearings

For bearings with relatively small interference, the entire circumference of the raceway can be uniformly press-fit at room temperature as shown in **Fig. 15.3**. Usually, bearings are installed by striking the sleeve with a hammer; however, when installing a large number of bearings, a mechanical or hydraulic press should be used.

When installing non-separable bearings on a shaft and in a housing simultaneously, a pad which distributes the fitting pressure evenly over the inner and outer rings is used as shown in **Fig. 15.4**. If the fitting is too tight or bearing size is large, a considerable amount of force is required to install the bearing at room temperature. Installation can be facilitated by heating and expanding the inner ring beforehand. The required relative temperature difference between the inner ring and the shaft depends on the amount of interference and the shaft fitting surface diameter. **Fig. 15.5** shows the relation between the bearing inner bore diameter temperature differential and the amount of thermal expansion. **In any**

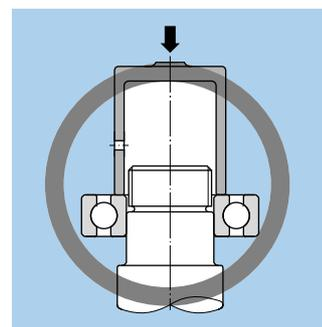

Fig. 15.3 Fitting sleeve pressure against inner ring

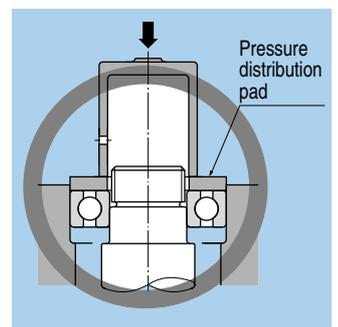

Fig. 15.4 Fitting sleeve pressure against inner /outer ring simultaneously

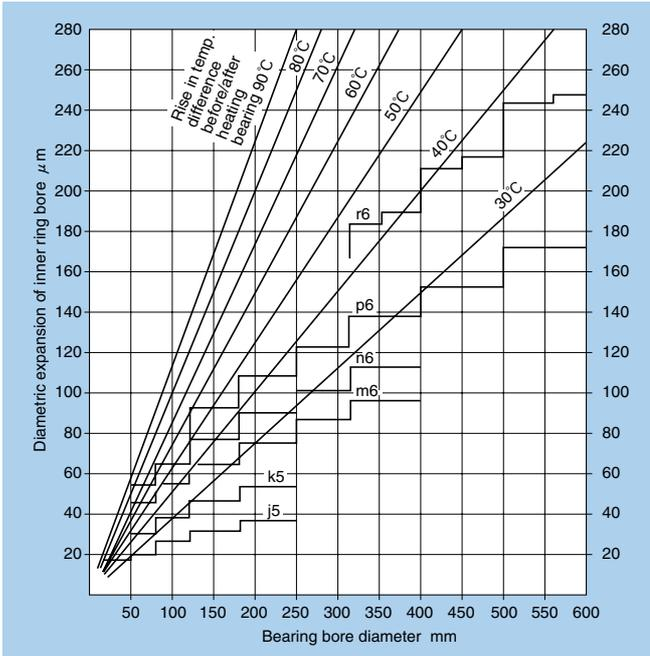

Fig. 15.5 Temperature required for heat-fitting inner ring

event, bearings should never be heated above 120°C.

The most commonly used method of heating bearings is to immerse them in hot oil. This method must not be used for sealed bearings or shield bearings with grease sealed inside.

To avoid overheating parts of the bearings they should never be brought into direct contact with the heat source, but instead should be suspended inside the heating tank or placed on a wire grid.

If heating the bearing with air in a device such as a thermostatic chamber, the bearing can be handled while dry.

For heating the inner rings of NU, NJ or NUP cylindrical and similar type bearings without any ribs or with only a single rib, an induction heater can be used to quickly heat bearings in a dry state (**must demagnetize**).

When heated bearings are installed on shafts, the inner rings must be held against the shaft abutment until the bearing has been cooled in order to prevent clearance between the ring and the abutment face.

As shown in Fig. 15.6, a removal pawl, or tool, can also be used to dismount the inner ring when using the induction heating method described above.

15.2.3 Installation of tapered bore bearings

Small type bearings with tapered bores are installed over a tapered shaft, withdrawal sleeves, or adapter sleeves by driving the bearing into place using a locknut. The locknut is tightened using a hammer or impact wrench. (Fig. 15.7)

Large size bearings require considerable fitting force and must be installed hydraulically.

In Fig. 15.8 the fitting surface friction and nut tightening torque needed to install bearings with tapered bores directly onto tapered shafts are decreased by injecting

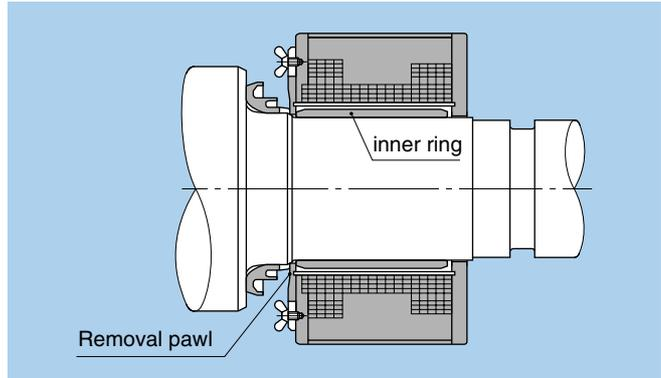

Fig. 15.6 Removal of inner ring using an induction heater

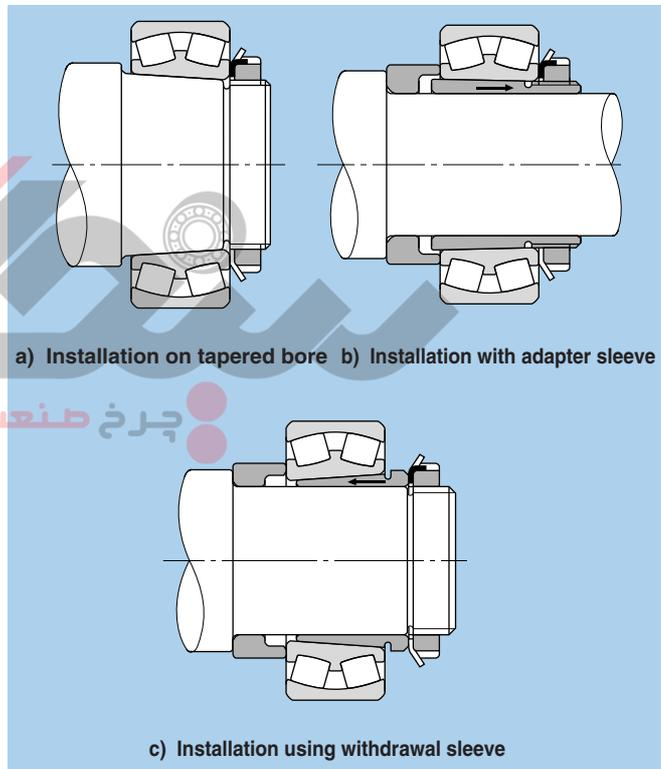

Fig. 15.7 Installation methods using locknuts

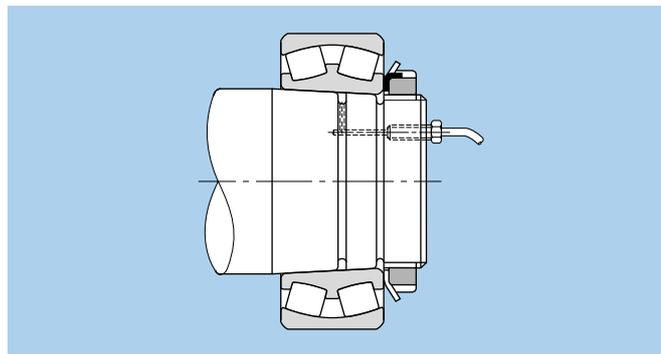

Fig. 15.8 Installation utilizing oil injection

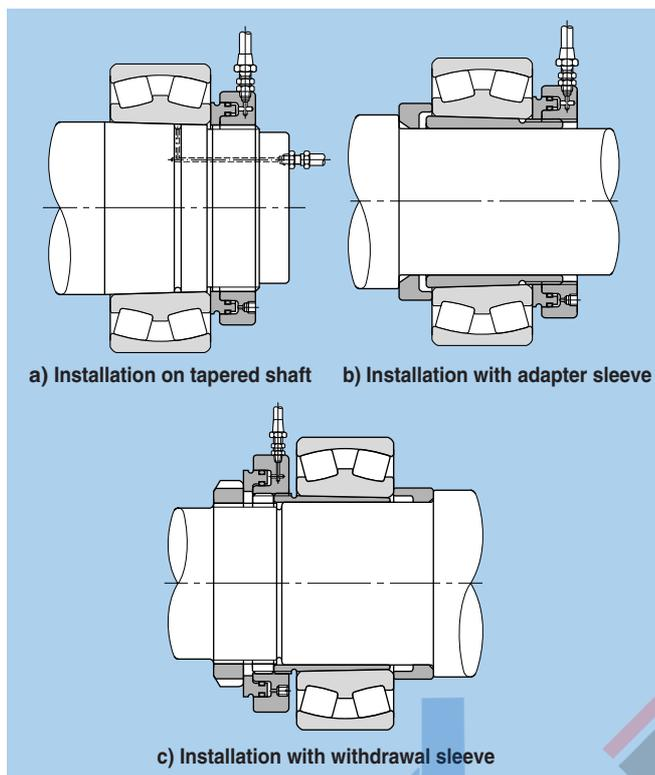

Fig. 15.9 Installation using hydraulic nut

high pressure oil between the fitting surfaces.

Fig. 15.9 a) shows one method of installation where a hydraulic nut is used to drive the bearing onto a tapered shaft.

Fig. 15.9 b) and **c)** show installation using a hydraulic nut with adapter sleeves and withdrawal sleeves.

Fig. 15.10 shows an installation method using a hydraulic withdrawal sleeve.

With tapered bore bearings, as the inner ring is driven axially onto the shaft or adapter or withdrawal sleeve, the interference will increase and the bearing internal radial clearance will decrease. Interference can be estimated by measuring decrease in internal radial clearance. As shown in **Fig. 15.11**, the internal radial clearance between the rollers and outer ring of spherical roller bearings should be measured with a thickness gauge under no load while the rollers are held in the correct position. Instead of using the decrease in amount of internal radial clearance to estimate the interference, it is possible to estimate by measuring the distance the bearing has been driven onto the shaft.

For spherical roller bearings, **Table 15.1** indicates the appropriate interference which will be achieved as a result of the internal radial clearance decrease, or the distance the bearing has been driven onto the shaft.

For conditions such as heavy loads, high speeds, or when there is a large temperature differential between the inner and outer rings, etc. which require large interference fits, bearings which have a minimum internal radial clearance of C3 or greater should be used. **Table 15.1** lists the maximum values for internal radial clearance

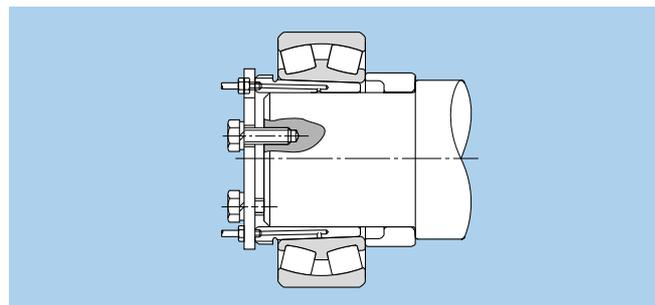

Fig. 15.10 Installation using hydraulic withdrawal sleeve

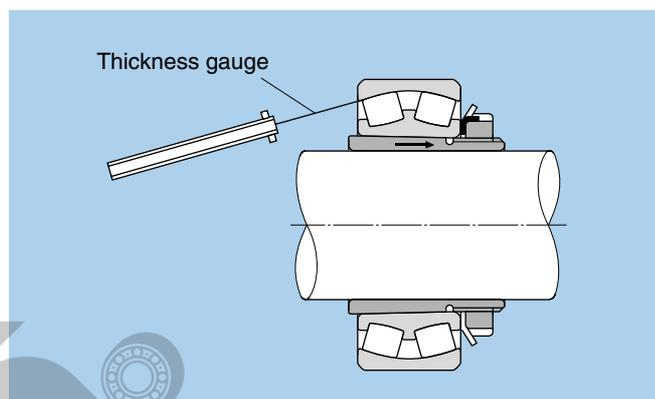

Fig. 15.11 Internal clearance measurement method for spherical roller bearings

decrease and axial displacement. For these applications, the remaining clearance must be greater than the minimum allowable residual clearance listed in **Table 15.1**.

15.2.4 Installation of outer ring

Even for tight interference fits, the outer rings of small type bearings can be installed by driving them into housings at room temperature. For large interference type bearings, the housing can be heated before installing the bearing, or the bearing's outer ring can be cooled with dry ice, etc. before installing. If dry ice or other cooling agent is used, atmospheric moisture will condense on bearing surfaces, and therefore appropriate rust preventative measures are necessary.

15.3 Internal clearance adjustment

As shown in **Fig. 15.12**, for angular contact ball bearings and tapered roller bearings the desired amount of axial internal clearance can be set at the time of installation by tightening or loosening the adjustment nut.

To adjust the suitable axial internal clearance or amount of bearing preload, the internal clearance can be measured while tightening the adjusting nut as shown in **Fig. 15.13**. Other methods are to check rotation torque by rotating the shaft or housing while adjusting the nut, or to insert shims of the proper thickness as shown in **Fig. 15.14**.

Table 15.1 Installation of tapered bore spherical roller bearings

Units mm

Nominal bearing bore diameter d		Reduction of radial internal clearance		Axial displacement drive up				Minimum allowable residual clearance		
over	incl.	Min	Max	Taper, 1:12		Taper, 1:30		CN	C3	C4
				Min	Max	Min	Max			
30	40	0.02	0.025	0.35	0.4	—	—	0.015	0.025	0.04
40	50	0.025	0.03	0.4	0.45	—	—	0.02	0.03	0.05
50	65	0.03	0.035	0.45	0.6	—	—	0.025	0.035	0.055
65	80	0.04	0.045	0.6	0.7	—	—	0.025	0.04	0.07
80	100	0.045	0.055	0.7	0.8	1.75	2.25	0.035	0.05	0.08
100	120	0.05	0.06	0.75	0.9	1.9	2.25	0.05	0.065	0.1
120	140	0.065	0.075	1.1	1.2	2.75	3	0.055	0.08	0.11
140	160	0.075	0.09	1.2	1.4	3	3.75	0.055	0.09	0.13
160	180	0.08	0.1	1.3	1.6	3.25	4	0.06	0.1	0.15
180	200	0.09	0.11	1.4	1.7	3.5	4.25	0.07	0.1	0.16
200	225	0.1	0.12	1.6	1.9	4	4.75	0.08	0.12	0.18
225	250	0.11	0.13	1.7	2	4.25	5	0.09	0.13	0.2
250	280	0.12	0.15	1.9	2.4	4.75	6	0.1	0.14	0.22
280	315	0.13	0.16	2	2.5	5	6.25	0.11	0.15	0.24
315	355	0.15	0.18	2.4	2.8	6	7	0.12	0.17	0.26
355	400	0.17	0.21	2.6	3.3	6.5	8.25	0.13	0.19	0.29
400	450	0.2	0.24	3.1	3.7	7.75	9.25	0.13	0.2	0.31
450	500	0.21	0.26	3.3	4	8.25	10	0.16	0.23	0.35
500	560	0.24	0.3	3.7	4.6	9.25	11.5	0.17	0.25	0.36
560	630	0.26	0.33	4	5.1	10	12.5	0.2	0.29	0.41
630	710	0.3	0.37	4.6	5.7	11.5	14.5	0.21	0.31	0.45
710	800	0.34	0.43	5.3	6.7	13.3	16.5	0.23	0.35	0.51
800	900	0.37	0.47	5.7	7.3	14.3	18.5	0.27	0.39	0.57
900	1,000	0.41	0.53	6.3	8.2	15.8	20.5	0.3	0.43	0.64
1,000	1,120	0.45	0.58	6.8	8.7	17	22.5	0.32	0.48	0.7
1,120	1,250	0.49	0.63	7.4	9.4	18.5	24.5	0.34	0.54	0.77

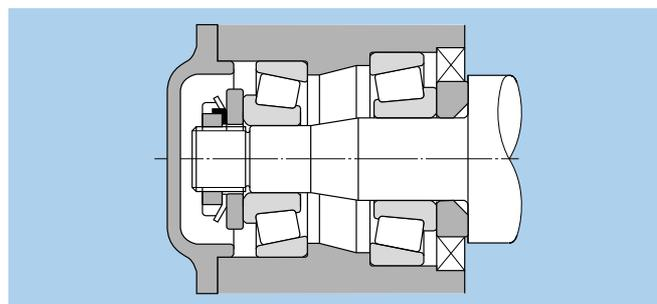

Fig. 15.12 Axial internal clearance adjustment

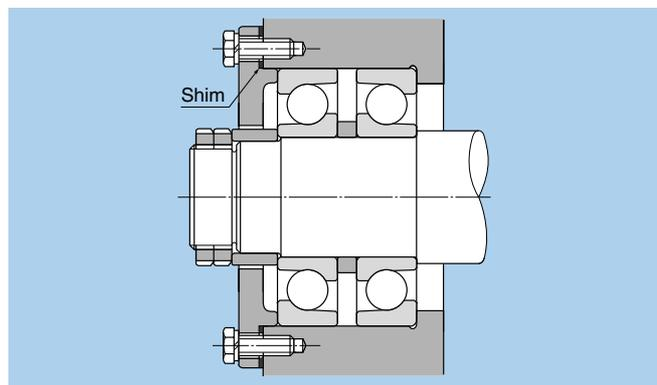

Fig. 15.14 Internal clearance adjustment using shims

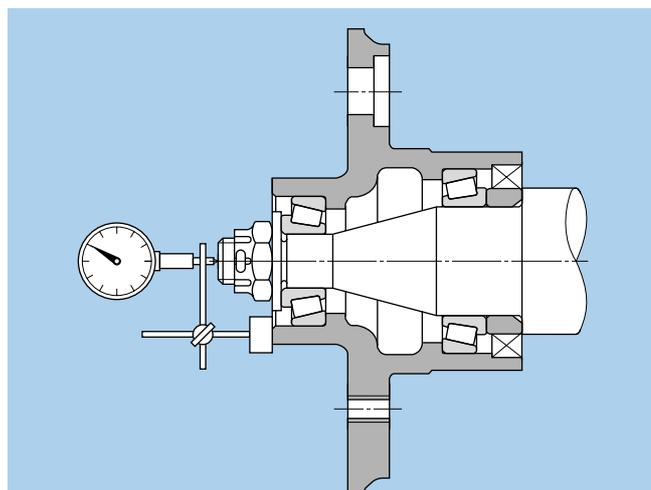

Fig. 15.13 Measurement of axial internal clearance adjustment

15.4 Post installation running test

To insure that the bearing has been properly installed, a running test is performed after installation is completed. The shaft or housing is first rotated by hand and if no problems are observed low speed, no load power test is performed. If no abnormalities are observed, **the load and speed are gradually increased to operating conditions. During the test if any unusual noise, vibration, or temperature rise is observed the test should be stopped and examine the equipment. If necessary, the bearing should be disassembled for inspection.**

To check bearing running noise, the sound can be amplified and the type of noise ascertained with a listening instrument placed against the housing. A clear, smooth and continuous running sound is normal. A high, metallic or irregular sound indicates some error in function. Vibration can be accurately checked with a vibration measuring instrument, and the amplitude and frequency characteristics measured quantitatively.

Usually the bearing temperature can be estimated from the housing surface temperature. However, if the bearing outer ring is accessible through oil inlets, etc., the temperature can be more accurately measured.

Under normal conditions, bearing temperature rises with operation time and then reaches a stable operating temperature after a certain period of time. If the temperature does not stable and continues to rise, or if there is a sudden temperature rise, or if the temperature is extremely high, the bearing should be inspected.

15.5 Bearing disassembly

Bearings are often removed as part of periodic inspection procedures or during the replacement of other parts. However, the shaft and housing are almost always reinstalled, and in more than a few cases the bearings themselves are reused. These bearings, shafts, housings, and other related parts must be designed to prevent damage during disassembly procedures, and the proper disassembly tools must be employed. When removing raceways with interference, pulling force should be applied to the raceway only. **Do not remove the raceway through the rolling elements.**

15.5.1 Disassembly of bearings with cylindrical bores

For small type bearings, the pullers shown in **Fig. 15.15 a) and b)** or the press method shown in **Fig. 15.16** can be used for disassembly. When used properly, these methods can improve disassembly efficiency and prevent damage to bearings.

To facilitate disassembly procedures, attention should be given to planning the designs of shafts and housings, such as providing extraction grooves on the shaft and housing for puller claws as shown **Figs. 15.17 and 15.18**. Threaded bolt holes should also be provided in housings to facilitate the pressing out of outer rings as shown in **Fig. 15.19**.

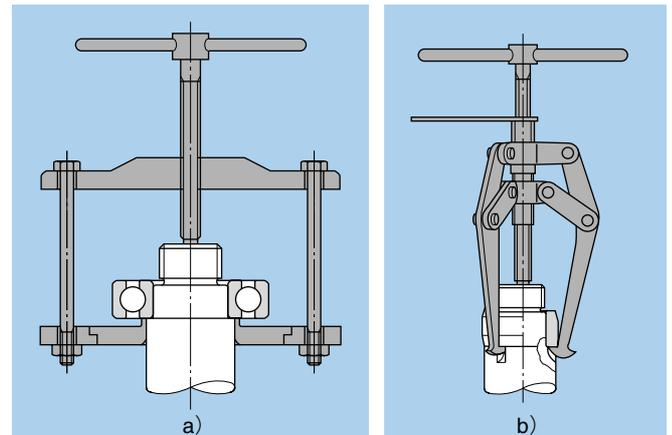

Fig. 15.15 Puller disassembly

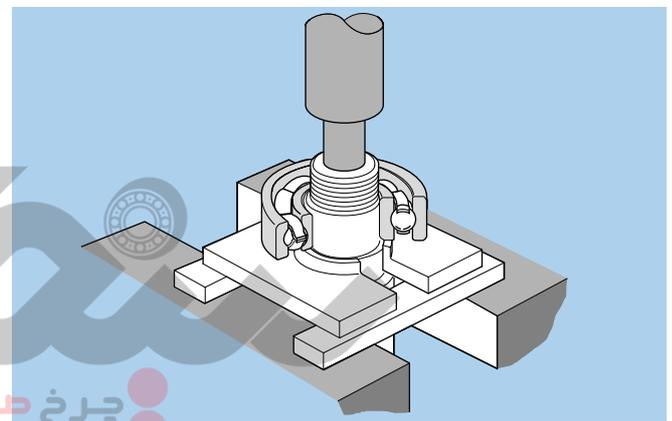

Fig. 15.16 Press disassembly

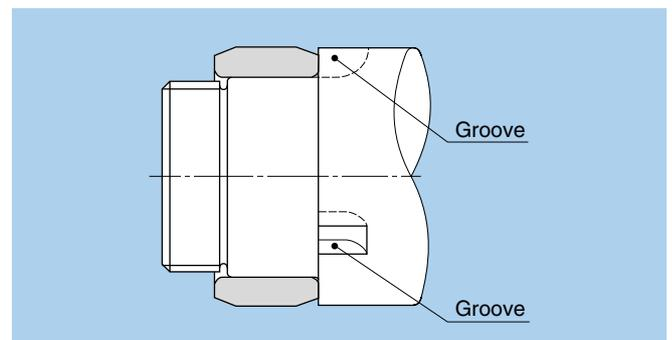

Fig. 15.17 Extracting grooves

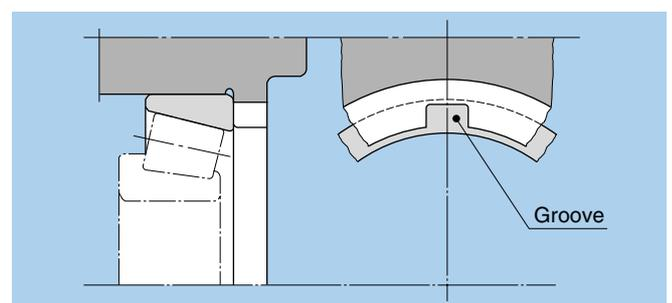

Fig. 15.18 Extraction groove for outer ring disassembly

Large bearings, installed with tight fits, and having been in service for a long period of time, will likely have developed fretting corrosion on fitting surfaces and will require considerable dismounting force. In such instances, dismounting friction can be reduced by injecting oil under high pressure between the shaft and inner ring surfaces as shown in **Fig. 15.20**.

For NU, NJ and NUP type cylindrical roller bearings, the induction heating unit shown in **Fig. 15.6** can be used to facilitate removal of the inner ring by means of thermal expansion. This method is highly efficient for frequent disassembly of bearings with identical dimensions.

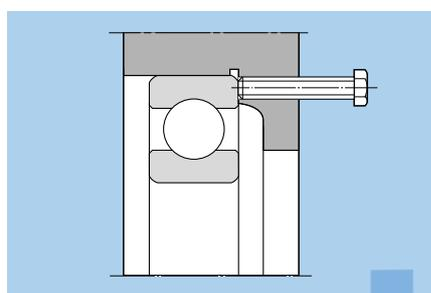

Fig. 15.19 Outer ring disassembly bolt

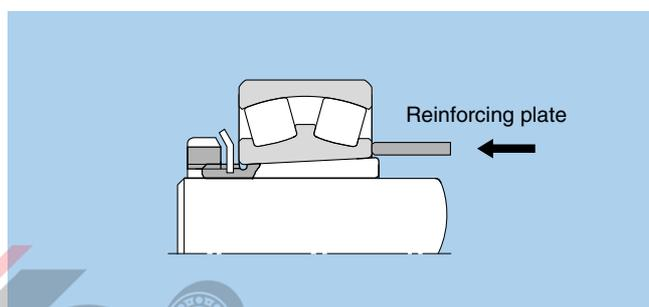

Fig. 15.21 Disassembly of bearing with adapter

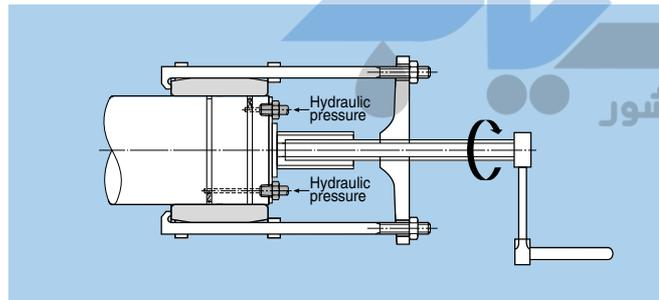

Fig. 15.20 Removal by hydraulic pressure

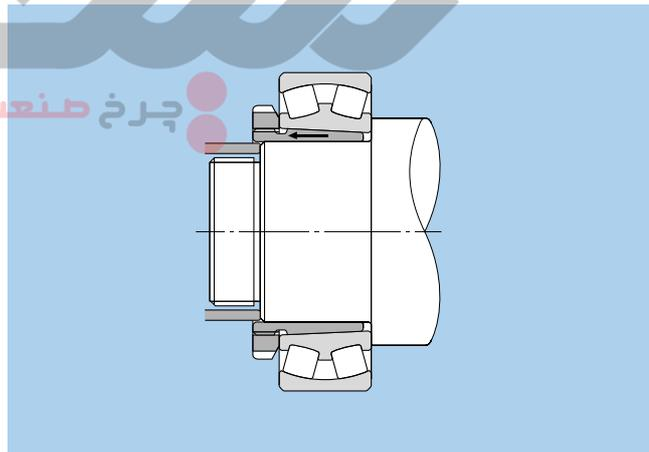

Fig. 15.22 Disassembly of bearing with withdrawal sleeve

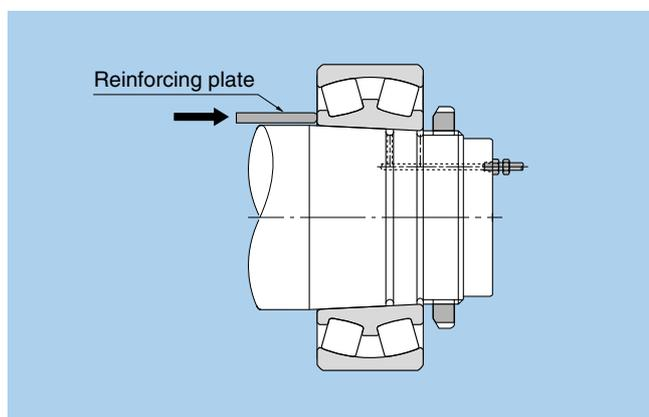

Fig. 15.23 Removal of bearing by hydraulic pressure

Fig. 15.24 shows two methods of disassembling bearings with adapters or withdrawal sleeves using a hydraulic nut. Fig. 15.25 shows a disassembly method using a hydraulic withdrawal sleeve where high pressure oil is injected between fitting surfaces and a nut is then employed to remove the sleeve.

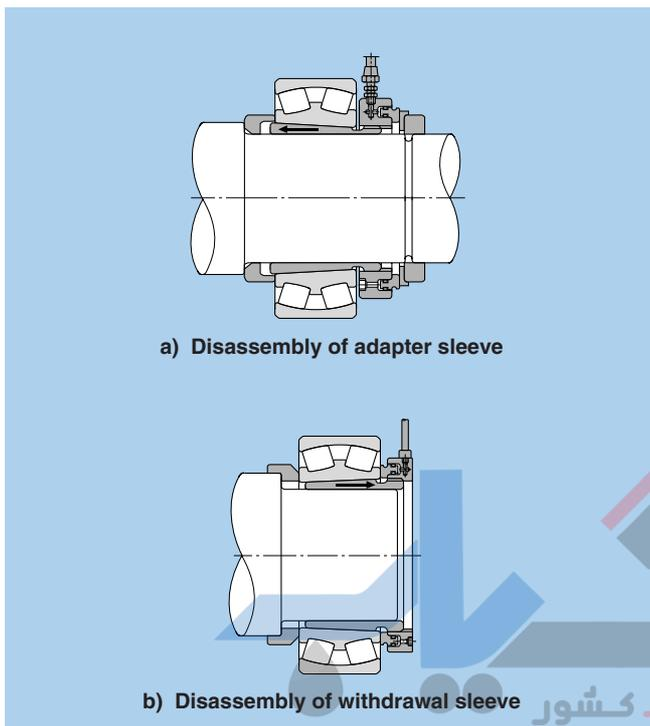

Fig. 15.24 Disassembly using hydraulic nut

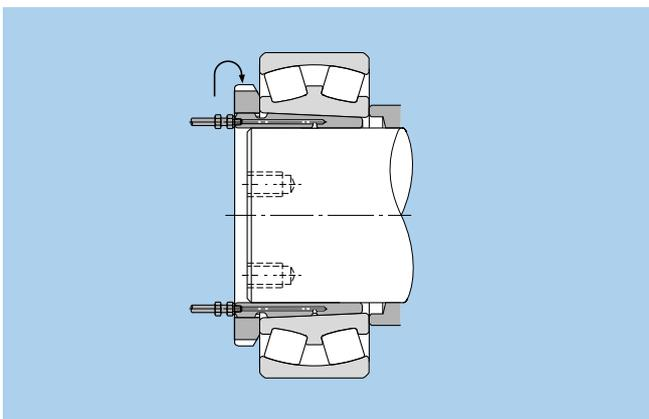

Fig. 15.25 Disassembly using hydraulic withdrawal sleeve

15.6 Bearing maintenance and inspection

In order to get the use the bearing to its full potential and keep it in good working condition as long as possible, maintenance and inspections should be performed. Doing so will enable early detection of any problems with the bearing.

This will enable you to prevent bearing failure before it happens, and will enhance productivity and cost performance.

The following measures are often taken as a general method of maintaining and managing bearings.

Maintenance management requires inspection items and frequency for performing routine inspections be determined according to the importance of the device or machine.

15.6.1 Inspection of machine while running

The interval for replenishing and replacing lubricant is determined by a study of lubricant nature and checking the bearing temperature, noise and vibration.

15.6.2 Observation of bearing after use

Take note of any problem that may appear after the bearing is used or when performing routine inspections, and take measures for preventing reoccurrence of any damage discovered. For types of bearing damage and countermeasures for preventing damage, see section 16.

16. Bearing Damage and Corrective Measures

If handled correctly, bearings can generally be used for a long time before reaching their fatigue life. If damage occurs prematurely, the problem could stem from improper bearing selection, handling or lubrication. In this occurs, take note of the type of machine on which the bearings is used, the place where it is mounted, service

conditions and surrounding structure. By investigating several possible causes surmised from the type of damage and condition at the time the damage occurred, it is possible to prevent the same kind of damage from reoccurring. **Table 16.1** gives the main causes of bearing damage and remedies for correcting the problem.

Table 16.1 Bearing damage, main causes of bearing damage and remedies for correcting the problem

Description		
<p>Flaking</p> <p>Surface of the raceway and rolling elements peels away in flakes Conspicuous hills and valleys form soon afterward.</p> 	<p>Causes</p> <ul style="list-style-type: none"> • Excessive load, fatigue life, improper handling • Improper mounting. • Improper precision in the shaft or housing. • Insufficient clearance. • Contamination. • Rust. • Improper lubrication • Drop in hardness due to abnormally high temperatures. <p>Correction</p> <ul style="list-style-type: none"> • Select a different type of bearing. • Reevaluate the clearance. • Improve the precision of the shaft and housing. • Review application conditions. • Improve assembly method and handling. • Reevaluate the layout (design) of the area around the bearing. • Review lubricant type and lubrication methods. 	
<p>Seizure</p> <p>The bearing heats up and becomes discolored. Eventually the bearing will seize up.</p> 	<p>Causes</p> <ul style="list-style-type: none"> • Insufficient clearance (including clearances made smaller by local deformation). • Insufficient lubrication or improper lubricant. • Excessive loads (excessive preload). • Skewed rollers. • Reduction in hardness due to abnormal temperature rise <p>Correction</p> <ul style="list-style-type: none"> • Riview lubricant type and quantity. • Check for proper clearance. (Increase clearances.) • Take steps to prevent misalignment. • Review application conditions. • Improve assembly method and handling. 	
<p>Cracking and notching</p> <p>Localized flaking occurs. Little cracks or notches appear.</p> 	<p>Causes</p> <ul style="list-style-type: none"> • Excessive shock loads. • Improper handling (use of steel hammer, cutting by large particles of foreign matter) • Formation of decomposed surface layer due to improper lubrication • Excessive interference. • Large flaking. • Friction cracking. • Imprecision of mounting mate (oversized fillet radius) <p>Correction</p> <ul style="list-style-type: none"> • Review lubricant (friction crack prevention). • Select proper interference and review materials. • Review service conditions. • Improve assembly procedures and take more care in handling. 	

Table 16.1 Bearing damage, main causes of bearing damage and remedies for correcting the problem

Description		
Cage damage Rivets break or become loose resulting in cage damage.		Causes <ul style="list-style-type: none"> Excessive moment loading. High speed or excessive speed fluctuations. Inadequate lubrication. Impact with foreign objects. Excessive vibration. Improper mounting. (Mounted misaligned)
		Correction <ul style="list-style-type: none"> Reevaluation of lubrication conditions. Review of cage type selection. Investigate shaft and housing rigidity. Review service conditions. Improve assembly method and handling.
Rolling path skewing Abrasion or an irregular, rolling path skewing left by rolling elements along raceway surfaces.		Causes <ul style="list-style-type: none"> Shaft or housing of insufficient accuracy. Improper installation. Insufficient shaft or housing rigidity. Shaft whirling caused by excessive internal bearing clearances.
		Correction <ul style="list-style-type: none"> Reinspect bearing's internal clearances. Review accuracy of shaft and housing finish. Review rigidity of shaft and housing.
Smearing and scuffing The surface becomes rough and some small deposits form. Scuffing generally refers to roughness on the race collar and the ends of the rollers.		Causes <ul style="list-style-type: none"> Inadequate lubrication. Entrapped foreign particles. Roller skewing due to a misaligned bearing. Bare spots in the collar oil film due to large axial loading. Surface roughness. Excessive slippage of the rolling elements.
		Correction <ul style="list-style-type: none"> Reevaluation of the lubricant type and lubrication method. Bolster sealing performance. Review preload. Review service conditions. Improve assembly method and handling
Rust and corrosion The surface becomes either partially or fully rusted, and occasionally rust even occurs along the rolling element pitch lines.		Causes <ul style="list-style-type: none"> Poor storage conditions. Poor packaging. Insufficient rust inhibitor. Penetration by water, acid, etc. Handling with bare hands.
		Correction <ul style="list-style-type: none"> Take measures to prevent rusting while in storage. Periodically inspect the lubricating oil. Improve sealing performance. Improve assembly method and handling.

Bearing Damage and Corrective Measures

Table 16.1 Bearing damage, main causes of bearing damage and remedies for correcting the problem

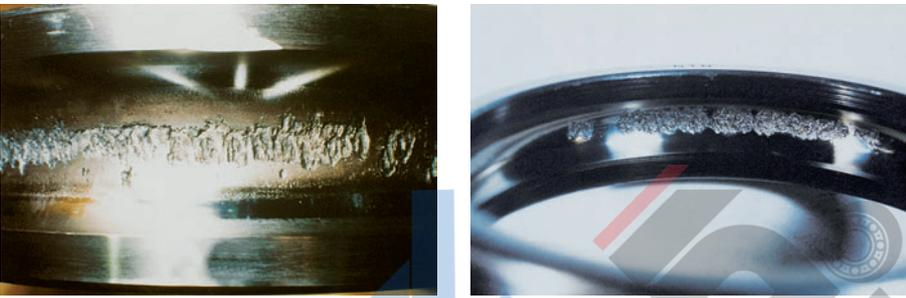
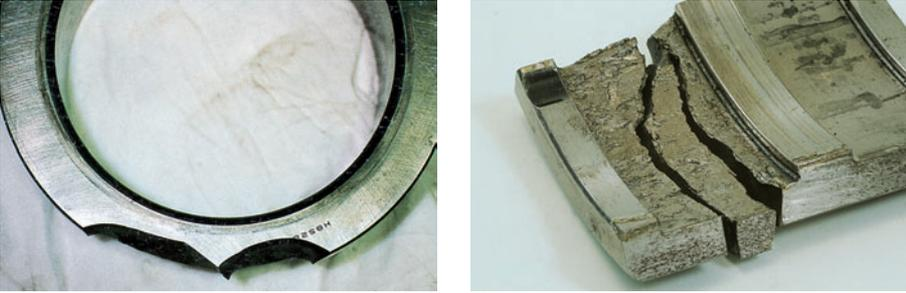
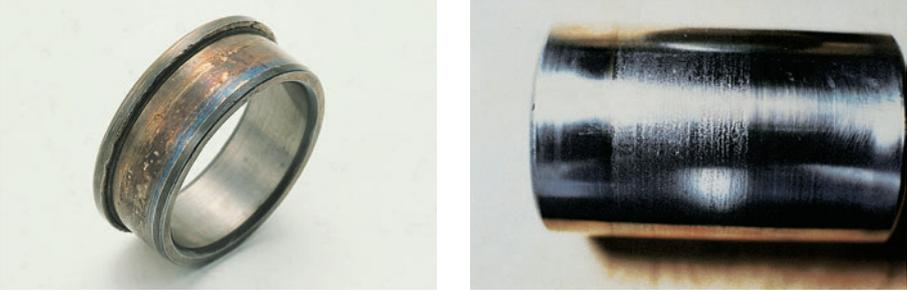
Description		
<p>Fretting</p> <p>There are two types of fretting. In one, a rusty wear powder forms on the mating surfaces. In the other, brinelling indentations form on the raceway at the rolling element pitch.</p> 	<p>Causes</p> <ul style="list-style-type: none"> • Insufficient interference. • Small bearing oscillation angle. • Insufficient lubrication.(unlubricated) • Fluctuating loads. • Vibration during transport, vibration while stopped. <p>Correction</p> <ul style="list-style-type: none"> • Select a different kind of bearing. • Select a different type of lubricant. • Review the interference and apply a coat of lubricant to fitting surface. • Pack the inner and outer rings separately for transport. 	
<p>Wear</p> <p>The surfaces wear and dimensional deformation results. Wear is often accompanied by roughness and scratches.</p> 	<p>Causes</p> <ul style="list-style-type: none"> • Entrapment of foreign particles in the lubricant. • Inadequate lubrication. • Skewed rollers. <p>Correction</p> <ul style="list-style-type: none"> • Review lubricant type and lubrication methods. • Improve sealing performance. • Take steps to prevent misalignment. 	
<p>Electrolytic corrosion</p> <p>Pits form on the raceway. The pits gradually grow into ripples.</p> 	<p>Causes</p> <ul style="list-style-type: none"> • Electric current flowing through the rollers. <p>Correction</p> <ul style="list-style-type: none"> • Create a bypass circuit for the current. • Insulate the bearing. 	
<p>Dents and scratches</p> <p>Scoring during assembly, gouges due to hard foreign objects, and surface denting due to mechanical shock.</p> 	<p>Causes</p> <ul style="list-style-type: none"> • Entrapment of foreign objects. • Bite-in on the flaked-off side. • Dropping or other mechanical shocks due to careless handling. • Assembled misaligned. <p>Correction</p> <ul style="list-style-type: none"> • Improve handling and assembly methods. • Bolster sealing performance. (measures for preventing foreign matter from getting in) • Check area surrounding bearing. (when caused by metal fragments) 	

Table 16.1 Bearing damage, main causes of bearing damage and remedies for correcting the problem

Description		
Creeping Surface becomes mirrored by sliding of inside and outside diameter surfaces. May be accompanied by discoloration or score.		Causes <ul style="list-style-type: none"> • Insufficient interference in the mating section. • Sleeve not fastened down properly. • Abnormal temperature rise. • Excessive loads.
		Correction <ul style="list-style-type: none"> • Reevaluate the interference. • Reevaluate usage conditions. • Review the precision of the shaft and housing. • Raceway end panel scuffing
Speckles and discoloration Luster of raceway surfaces is gone; surface is matted, rough, and / or evenly dimpled. Surface covered with minute dents.		Causes <ul style="list-style-type: none"> • Infiltration of bearing by foreign matter. • Insufficient lubrication.
		Correction <ul style="list-style-type: none"> • Reevaluation of lubricant type and lubrication method. • Review sealing mechanisms. • Examine lubrication oil purity. (filter may be excessively dirty, etc.)
Peeling Patches of minute flaking or peeling (size, approx. 10 μm). Innumerable hair-line cracks visible though not yet peeling. (This type of damage frequently seen on roller bearings.)		Causes <ul style="list-style-type: none"> • Infiltration of bearing by foreign matter. • Insufficient lubrication.
		Correction <ul style="list-style-type: none"> • Reevaluation of lubricant type and lubrication method. • Improve sealing performance. (to prevent infiltration of foreign matter) • Take care to operate smoothly.

17. Technical data

17.1 Deep groove ball bearing radial internal clearances and axial internal clearances

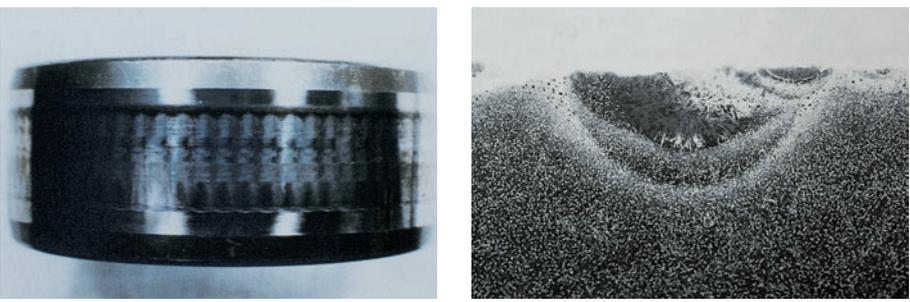
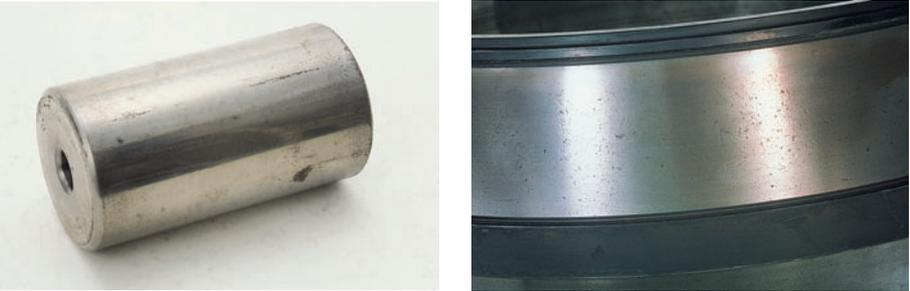
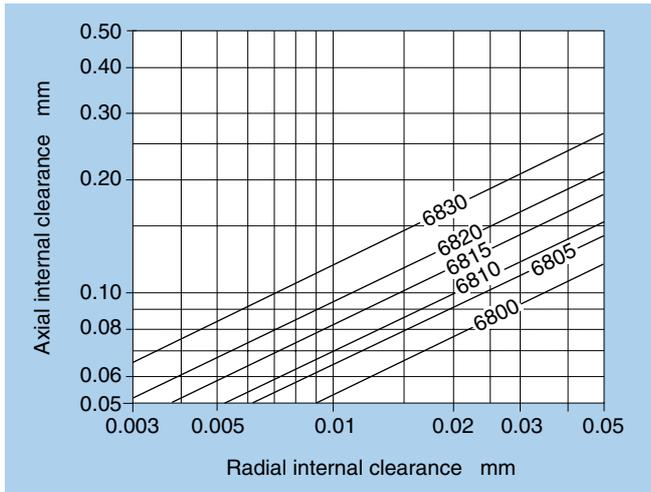

Fig. 17.1.1 Series 68 radial internal/axial internal clearances

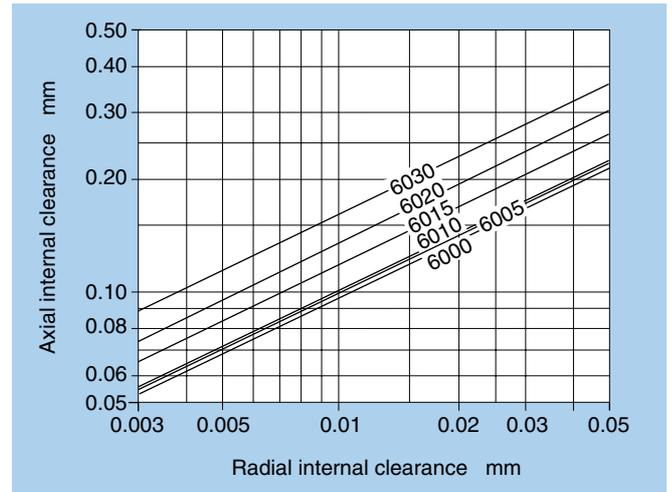

Fig. 17.1.3 Series 60 radial internal/axial internal clearances

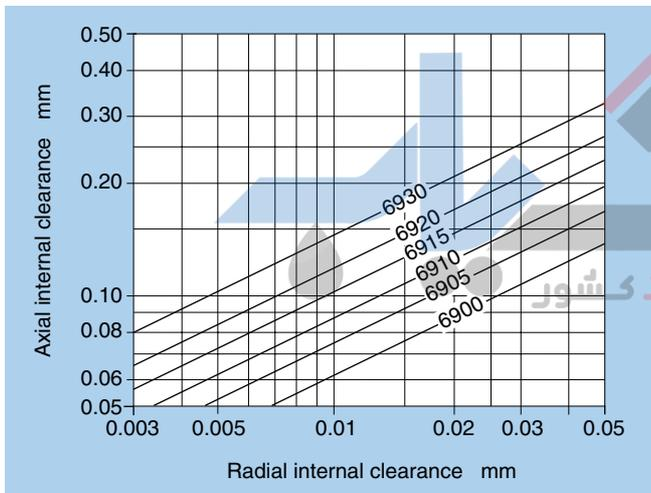

Fig. 17.1.2 Series 69 radial internal/axial internal clearances

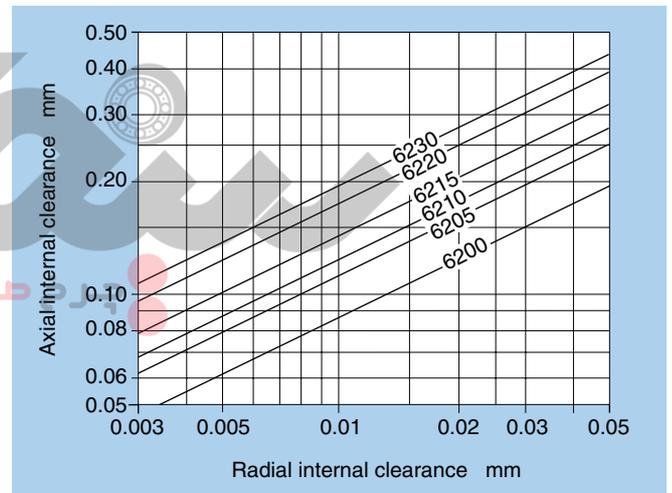

Fig. 17.1.4 Series 62 radial internal/axial internal clearances

※This data is based on typical dimensions. NTN do not guarantee at this data.

17.2 Angular contact ball bearing axial load and axial displacement

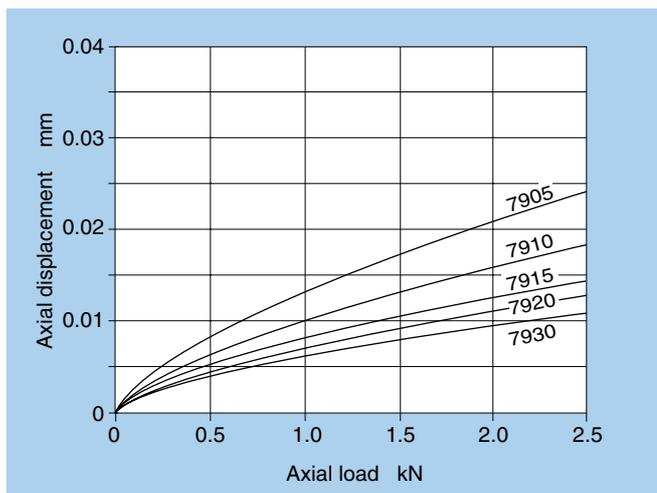

Fig. 17.2.1 Series 79 axial load and axial displacement

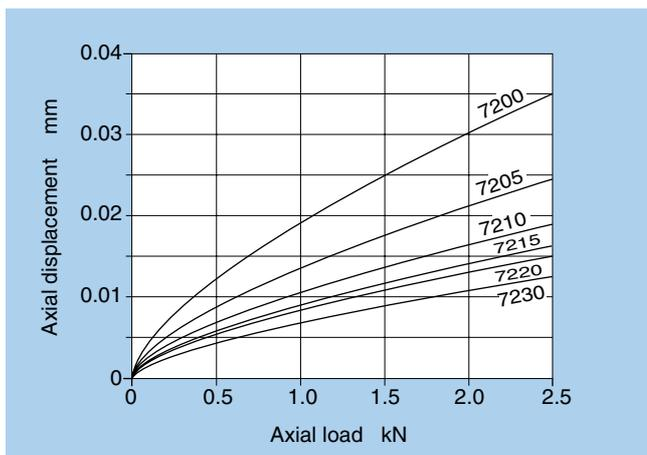

Fig. 17.2.4 Series 72 axial load and axial displacement

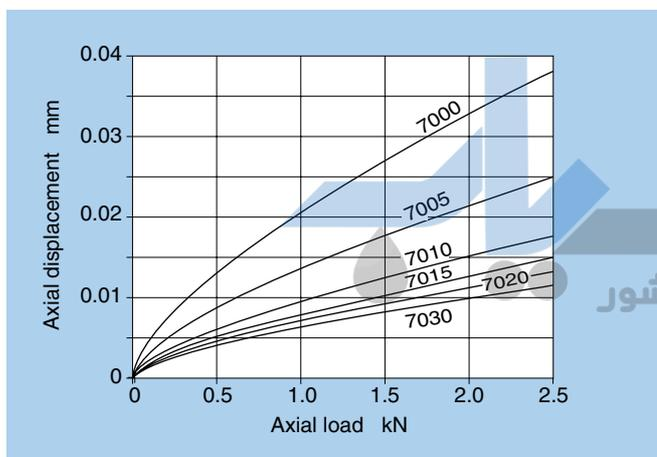

Fig. 17.2.2 Series 70 axial load and axial displacement

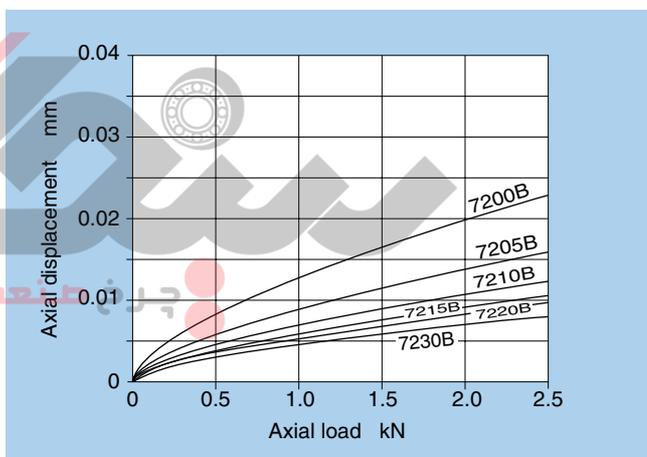

Fig. 17.2.5 Series 72 B axial load and axial displacement

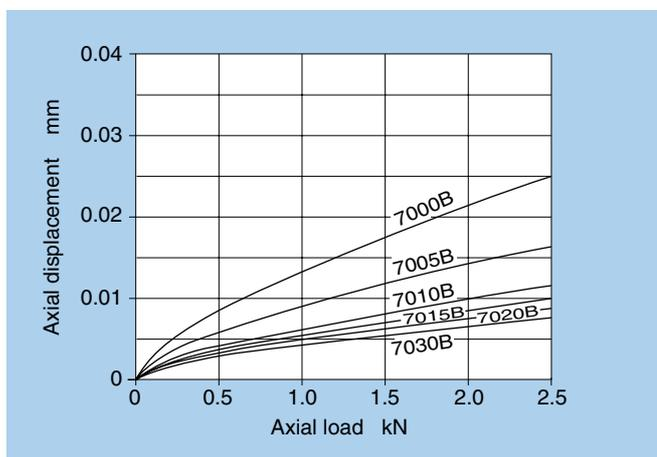

Fig. 17.2.3 Series 70 B axial load and axial displacement

※This data is based on typical dimensions. NTN do not guarantee at this data.

17.3 Tapered roller bearing axial load and axial displacement

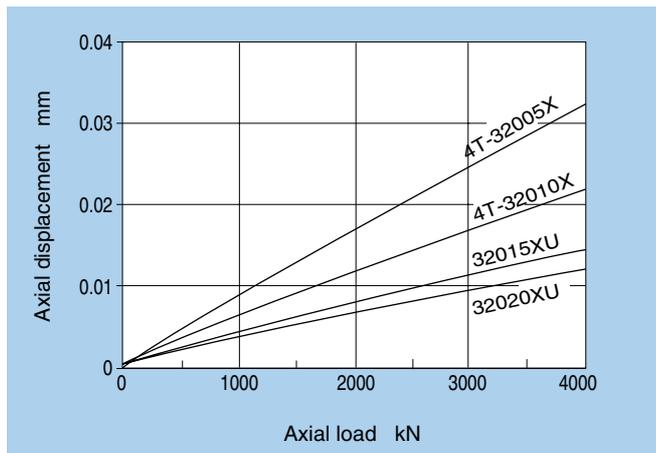

Fig. 17.3.1 Series 320 axial load and axial displacement

17.4 Allowable axial load for ball bearings

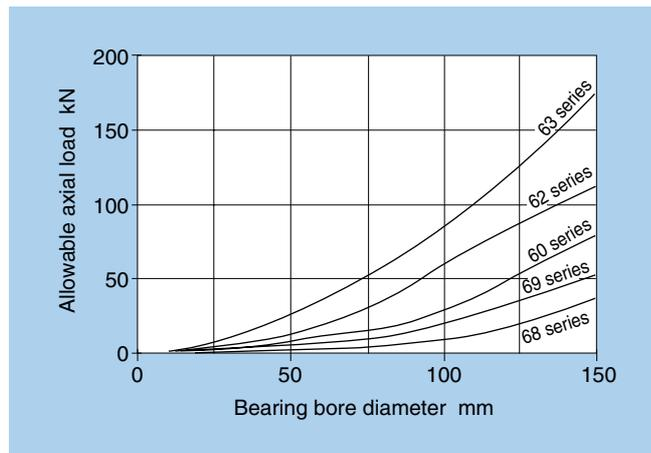

Fig. 17.4.1 Allowable axial load for deep groove ball bearings

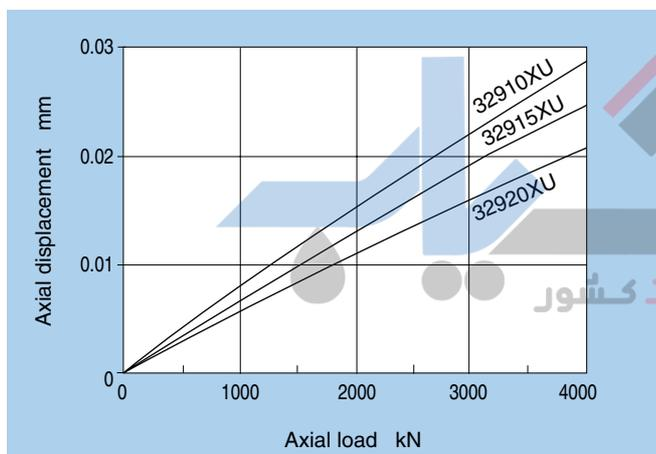

Fig. 17.3.2 Series 329 axial load and axial displacement

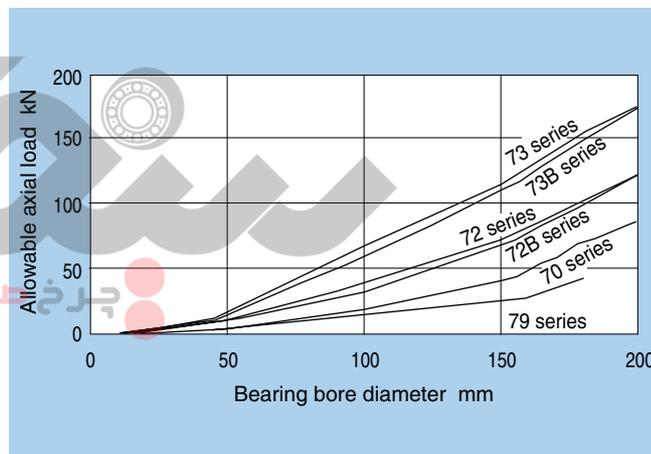

Fig. 17.4.2 Allowable axial load for angular contact ball bearings

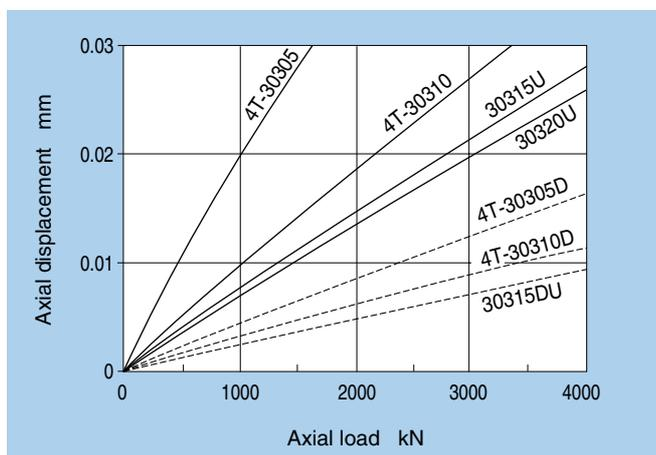

Fig. 17.3.3 Series 303/303 D axial load and axial displacement

Note: When an axial load acts upon deep groove or angular contact ball bearings, allowable axial load is the load whereby the contact ellipse exceeds the shoulder of the raceway.

Note: Values when bearing and housing are rigid bodies.
Axial displacement may become large depending on shape of shaft/housing and fitting conditions.

17.5 Fitting surface pressure

Table 17.5.1 lists equations for calculating the pressure and maximum stress between fitting surfaces.

Table 17.5.2 can be used to determine the approximate average groove diameter for bearing inner and outer rings.

The effective interference, in other words the actual interference Δ_{def} after fitting, is smaller than the apparent

interference Δd derived from the measured value for the bearing bore diameter and shaft. This difference is due to the roughness or variations of the finished surfaces to be fitted, and therefore it is necessary to assume the following reductions in effective interference:

- For ground shafts: 1.0 ~ 2.5 μ m
- For lathed shafts : 5.0 ~ 7.0 μ m

Table 17.5.1 Fitting surface pressure and maximum stress

Fit conditions		Equation	Codes (units: N {kgf} , mm)
Fitting surface pressure MPa {kgf / mm ² }	Solid steel shaft/ inner ring fit	$P = \frac{E}{2} \frac{\Delta_{def}}{d} \left[1 - \left(\frac{d}{D_i} \right)^2 \right]$	d : Shaft diameter, inner ring bore diameter d_o : Hollow shaft inner diameter D_i : Inner ring average groove diameter Δ_{def} : Effective interference E : Elasticity factor = 208,000 MPa { 21,200 kgf / mm ² }
	Hollow steel shaft/ inner ring fit	$P = \frac{E}{2} \frac{\Delta_{def}}{\Delta d} \frac{[1 - (d / D_i)^2] [1 - (d_o / d)^2]}{[1 - (d_o / D_i)^2]}$	D : Housing inner diameter, bearing outer diameter D_o : Outer ring average groove diameter D_h : Housing outer diameter Δ_{Def} : Effective interference
	Steel housing/ outer ring fit	$P = \frac{E}{2} \frac{\Delta_{Def}}{D} \frac{[1 - (D_o / D)^2] [1 - (D / D_h)^2]}{[1 - (D_o / D_h)^2]}$	
Maximum stress	Shaft / inner ring fit	$\sigma_{t \max} = P \frac{1 + (d / D_i)^2}{1 - (d / D_i)^2}$	Inner ring bore diameter face maximum tangential stress
MPa {kgf / mm ² }	Housing/ outer ring fit	$\sigma_{t \max} = P \frac{2}{1 - (D_o / D)^2}$	Outer ring inner diameter face maximum tangential stress

Table 17.5.2 Average groove diameter (approximate expression)

Bearing type		Average groove diameter	
		Inner ring (D_i)	Outer ring (D_o)
Deep groove ball bearings	All types	1.05 $\frac{4d + D}{5}$	0.95 $\frac{d + 4D}{5}$
Cylindrical roller bearings ^①	All types	1.05 $\frac{3d + D}{4}$	0.98 $\frac{d + 3D}{4}$
Spherical roller bearings	All types	$\frac{2d + D}{3}$	0.97 $\frac{d + 4D}{5}$

d : Inner ring bore diameter mm D : Outer ring outer diameter mm

① Average groove diameter values shown for double-flange type.

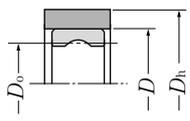
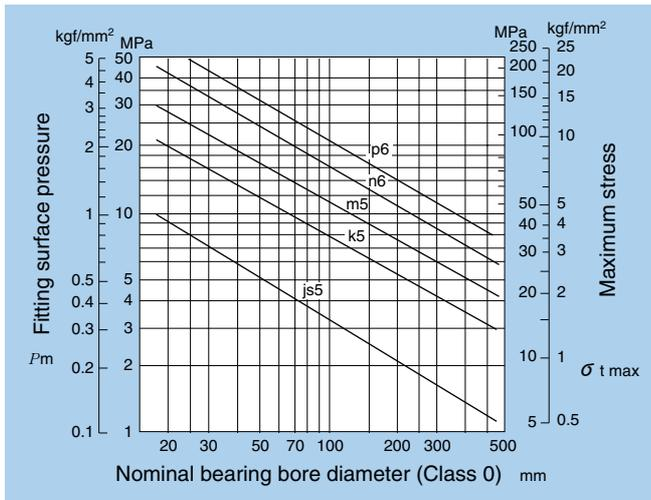

Fig. 17.5.1 Average fit interference as it relates to surface pressure Pm and max. stress σt max

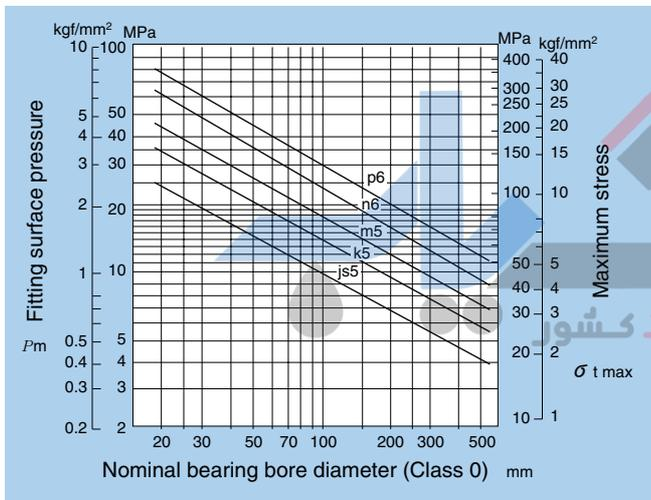

Fig. 17.5.2 Maximum fit interference as it relates to surface pressure Pm and max. stress σt max

17.6 Necessary press fit and pullout force

Equations (17.1) and (17.2) below can be used to calculate the necessary pullout force for press fit for inner rings and shafts or outer rings and housings.

For shaft and inner rings:

$$K_d = \mu \cdot P \cdot \pi \cdot d \cdot B \dots\dots\dots(17.1)$$

For housing and outer rings:

$$K_D = \mu \cdot P \cdot \pi \cdot D \cdot B \dots\dots\dots(17.2)$$

Where,

K_d : Inner ring press fit or pullout force N {kgf}

K_D : Outer ring press fit or pullout force N {kgf}

P : Fitting surface pressure MPa {kgf/mm²}

(Refer to **Table 17.5.1**)

d : Shaft diameter, inner ring bore diameter mm

D : Housing inner diameter, outer ring outer diameter mm

B : Inner or outer ring width

μ : Sliding friction coefficient (Refer to **Table 17.6.1**)

Table 17.6.1 Press fit and pullout sliding friction coefficient

Type	μ
Inner (outer) ring press fit onto cylindrical shaft (bore)	0.12
Inner (outer) ring pullout from cylindrical shaft (bore)	0.18
Inner ring press fit onto tapered shaft or sleeve	0.17
Inner ring pullout from tapered shaft	0.14
Sleeve press fit onto shaft/bearing	0.30
Sleeve pullout from shaft/bearing	0.33

① For recommended fitting, see page A-50.

Ball and Roller Bearings



INDEX OF BEARING TABLES

Deep Groove Ball Bearings	B-5
Deep groove ball bearings 67,68,69,160,60,62,63,64	B-8
Expansion compensating bearings EC-60,EC-62,EC-63	B-26
AC bearings AC-60, AC-A2, AC-63	B-28
Miniature and Extra Small Ball Bearings	B-31
Metric series 67,68,69,60,62,63,BC	B-34
Inch series R,RA	B-38
With ring grooves, snap rings SC	B-40
Angular Contact Ball Bearings	B-43
Single and duplex angular contact ball bearings 79,70,72,72B,73,73B	B-46
Four-point contact ball bearings QJ2,QJ3	B-58
Double row angular contact ball bearings 52,53	B-60
Self-Aligning Ball Bearings	B-65
12(K), 22(K), 13(K), 23(K)	B-66
Adapters for self-aligning ball bearings	B-72
Cylindrical Roller Bearings	B-77
NU,NJ,NUP,N,NF10,2,22,3,23,4	B-80
L type loose rib HJ2,22,3,23,4	B-98
Double row cylindrical roller bearings NN49(K),NNU49(K),NN30(K),NNU30(K)	B-102
Four-row cylindrical roller bearings 4R	B-108

Tapered Roller Bearings	B-119
Metric series 329X,320X,330,331,302,322,322C,332,303,303D,313X,323,323C	B-128
Inch series	B-146
Double row tapered roller bearings (back-to-back arrangement)	
4130,4230,4131,4231,4302,4322,4303,4303D,4323	B-184
Double row tapered roller bearings (face-to-face arrangement) 3230,3231	B-198
Four-row tapered roller bearings CR0	B-202
Spherical Roller Bearings	B-219
239(K),230(K),240(K30),231(K),241(K30),222(K),232(K),213(K),223(K)	B-222
Adapters for spherical roller bearings	B-242
Withdrawal sleeves for spherical roller bearings	B-247
Thrust Bearings	B-255
Single direction thrust ball bearings 511,512,513,514	B-258
Spherical roller thrust bearings 292,293,294	B-262

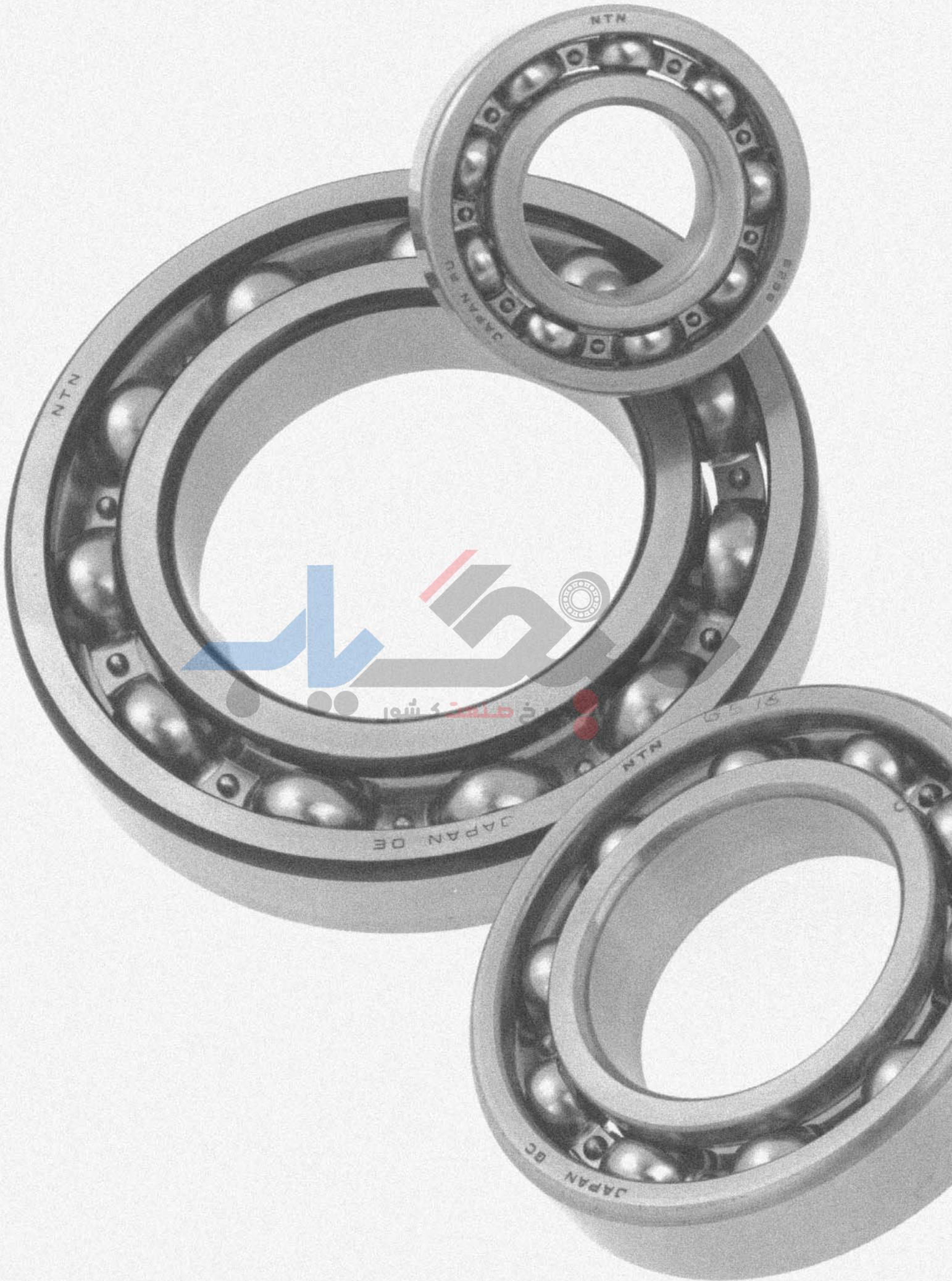

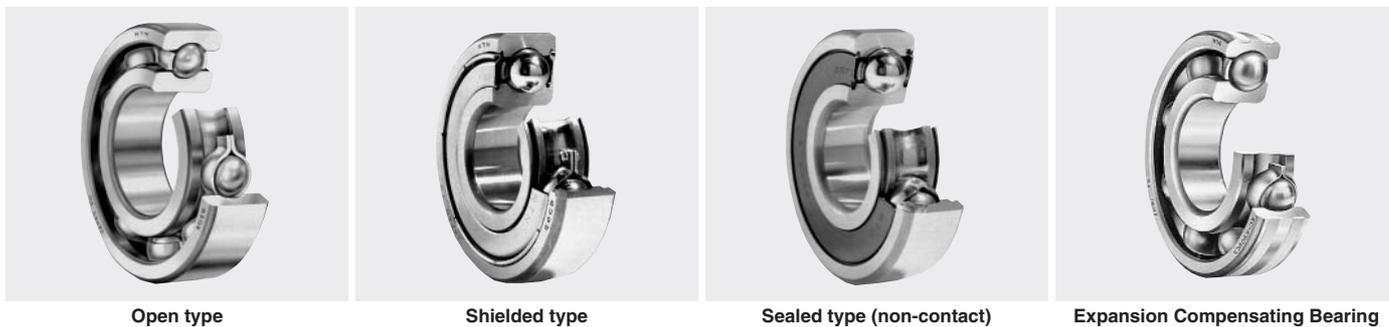

1. Design features and special characteristics

Deep groove ball bearings are very widely used. A deep groove is formed on each inner and outer ring of the bearing enabling them to sustain radial and axial loads in either direction as well as the complex loads which result from the combination of these forces. Deep groove ball bearings are suitable for high speed applications.

In addition to unsealed bearings, deep groove ball bearings include ball bearings with greased sealed inside (sealed or shielded) and bearings with a snap ring that simplify structure around the bearing and design.

Table 1 shows the construction and special characteristics of various sealed deep groove ball bearings.

Table 1 Sealed ball bearings: construction and characteristics

Type, code no.	Shielded type	Sealed type			
	Non-contact type ZZ	Non-contact type LLB	Contact type LLU	Low torque type LLH	
Construction					
	<ul style="list-style-type: none"> • Metal shield plate is affixed to outside ring; inner ring incorporates a V-groove and labyrinth clearance. 	<ul style="list-style-type: none"> • Outer ring incorporates synthetic rubber molded to a steel plate; seal edge is aligned with V-groove along inner ring surface with labyrinth clearance. 	<ul style="list-style-type: none"> • Outer ring incorporates synthetic rubber molded to a steel plate; seal edge contacts V-groove along inner ring surface. 	<ul style="list-style-type: none"> • Basic construction the same as LU type, but specially designed lip on edge of seal prevents penetration by foreign matter; low torque construction. 	
Performance comparison	Torque	Low	Low	Rather high	Medium
	Dust proofing	Very good	Better than ZZ-type	Excellent	Much better than LLB-type
	Water proofing	Poor	Poor	Very good	Very good
	High speed capacity	Same as open type	Same as open type	Limited by contact seals	Much better than LLU-type
	Allowable temp.range ①	Depends on lubricant	-25 °C ~ 120 °C	-25 °C ~ 110 °C	-25 °C ~ 120 °C

① Please consult NTN Engineering about applications which exceed the allowable temperature range of products listed on this table.
 Note : This chart lists double shielded and double sealed bearings, but single shielded (Z) and single sealed (LB, LU, LH) are also available.
 Grease lubrication should be used with single shielded and single sealed bearings.

2. Standard cage types

As shown in **Table 2**, pressed cages are generally used in deep groove ball bearings. Machined cages are however used for large bearings and high-speed bearings.

Table 2 Standard cage for deep groove ball bearings

Bearing series	Pressed cages	Machined cages
67	6700~ 6706	—
68	6800~ 6834	6836~ 68/600
69	6900~ 6934	6936~ 69/500
160	16001~16052	16056~ 16072
60	6000~ 6052	6056~ 6084
62	6200~ 6244	—
63	6300~ 6344	—
64	6403~ 6416	—

3. Other bearing types

3.1 Bearings with snap rings

Some bearings accommodate a snap ring which is attached along the outer diameter of the outer ring. By using snap rings, positioning in the axial direction is possible and housing installation is simplified. In addition to open type, shielded and sealed types are also manufactured. Consult NTN Engineering.

3.2 Expansion compensating bearings (creep prevention bearings)

The boundary dimensions of expansion compensating deep groove ball bearings are the same as for standard bearings, but formed high polymer material with a high expansion rate is provided in the grooves on the outer circumference of the outer ring (see **Diagram 1**).

Due to the extremely small difference of thermal expansion attained between the fitted surfaces of the high polymer equipped outer ring and the light alloy bearing housing, a good interference fit can be achieved with stable performance across a wide temperature range. Another

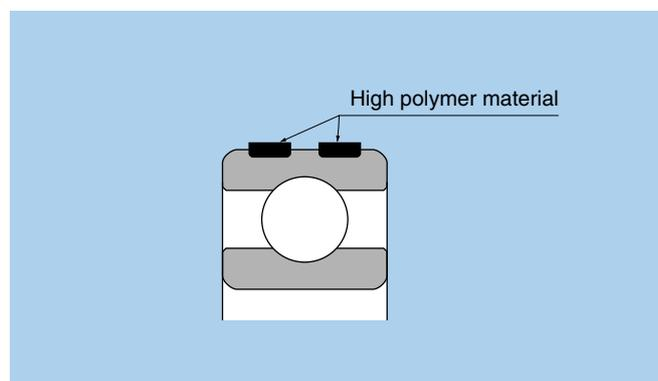

Diagram 1. Expansion compensating bearings

advantage is a large reduction in the occurrence of outer ring creeping.

(1) Allowable load

Maximum allowable load C_p (refer to the table of boundary dimensions) has been determined in accordance with outer ring strength; therefore, **it is necessary to select a bearing with a maximum allowable load greater than the largest anticipated bearing load.**

(2) Housing and bearing fit

Table 3 shows the recommended fits for bearings with light metal alloy housings.

In cases where the bearing is going to be interference fit with the housing, it is very important not to damage the high polymer material. Therefore it is essential that the lip of the housing diameter be given a $10^\circ\text{--}15^\circ$ chamfer as shown in **Diagram 2**.

Furthermore, as shown in **Diagram 2**, it is also advisable to apply the interference fit using a press in order not force the bearing into the housing in a misaligned position. (**Diagram 2**)

(3) Radial internal clearance

Regulations for radial internal clearance are the same as those for standard deep groove ball bearings. For standard fit and application conditions, a C3 clearance is used with

Table 3 Recommended fits for outer ring and housing bore

Conditions		Suitable bearing	Housing bore tolerance class
Load type, etc.	Housing material		
Rotating outer ring load Rotating inner ring load; light load Direction indeterminate load; ordinary load	Al alloy Mg alloy Other light alloys	Deep groove ball bearing Cylindrical roller bearing	H6
Rotating outer ring load; heavy load Direction indeterminate load; shock load	Al alloy Mg alloy Other light alloys	Thick-walled type deep groove ball bearing	N6

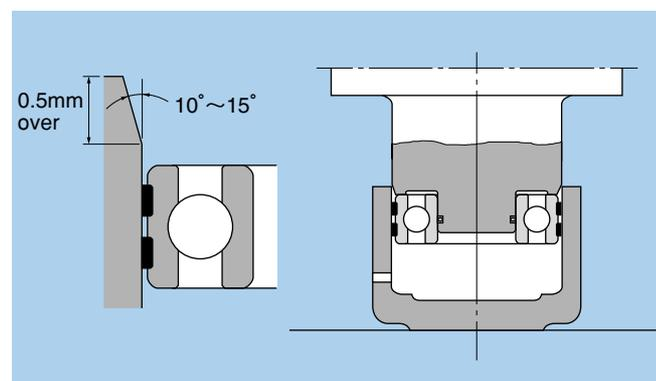

Diagram 2. Fitting method and housing inner diameter chamfer

this bearing.

For more detailed information concerning this bearing and the availability of roller bearings contact NTN Engineering.

(4) Allowable temperature range

-20 ~ 120 °C

3.3 Long-life bearings (TMB/TAB bearings)

Boundary dimensions of long-life bearings are the same as those of standard deep groove ball bearings, but the bearings have undergone special heat treatment that considerably extends wear life.

These bearings are especially effective in countering reduced wear life due to the effects of infiltration by dust and other foreign matter.

Features are as follows:

- Rated load is the same as standard bearings, but shaft characteristics factor is $\alpha_2 = 2.2$ for TMB bearings and $\alpha_2 = 3.6$ for TAB.
- TMB 62 series bearings can be used in place of standard 63 series bearings enabling lighter weight, more compact designs
- Greater resistance to reduced wear life due to infiltration by dust and other foreign matter

Dimensions for these bearings are not provided in the dimensions table. For details, please contact NTN Engineering.

3.4 AC bearings (creep prevention bearings)

AC bearings have the same boundary dimensions as standard bearings with the addition of two O-rings imbedded

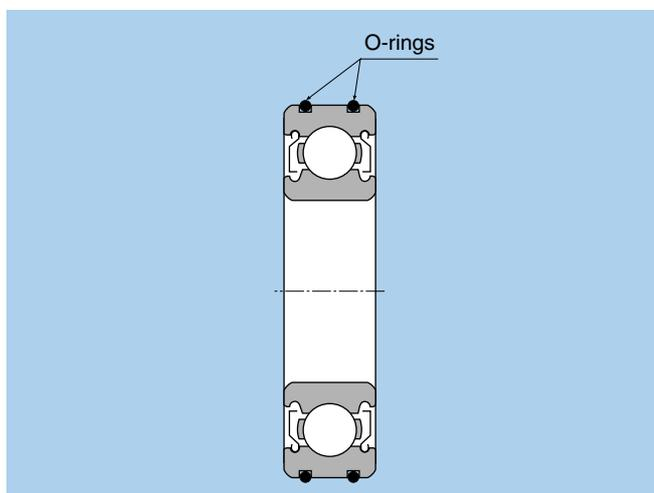

Diagram 3. AC bearing

in the outside circumference of the outer ring. (Diagram 3)

This bearing has a steel housing, can withstand rotating outer ring loads, and is suitable for applications where a "tight fit" is not possible but the fear of creeping exists. With its capacity for axial load displacement, an AC bearing can also be installed as a floating side bearing to accommodate shaft fluctuations. Before installing the bearing into the housing, high viscosity oil (base oil viscosity, 100 mm²/s or more) or grease should be applied to the space between the two O-rings. This lubricant forms a thin oil layer inside the bearing which prevents contact between the outer ring and housing, lowers the coefficient of friction, and is still able to prevent creeping by utilizing the friction force of the O-rings. Outer ring spin is prevented by friction force of the O-ring and housing.

For dimensional specifications, handling procedures, and other detailed information concerning AC bearings, contact NTN Engineering.

(1) Allowable load

Because allowable load C_p that takes outer ring strength into account (see dimensions table) is established, selection must be made so that maximum load on the bearing does not exceed C_p .

(2) Fit with housing

Table 4 gives recommended fit with steel housing.

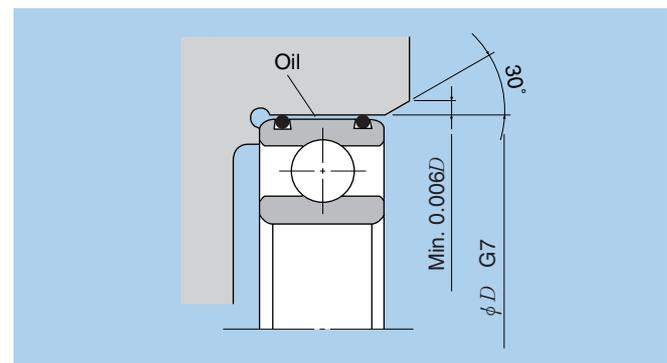

Diagram 4. Housing

Table 4 dimensions and shape

Housing bore tolerance	G7
Housing bore entrance chamfer	Max. 30°
Housing bore chamfer grinding undercut	Min. 0.006D
Housing bore finish roughness	2.5 μm Ra
Housing bore roundness	1/2 bearing housing dimension tolerance

(3) Allowable temperature range

-25 ~ 120 °C

Deep Groove Ball Bearings

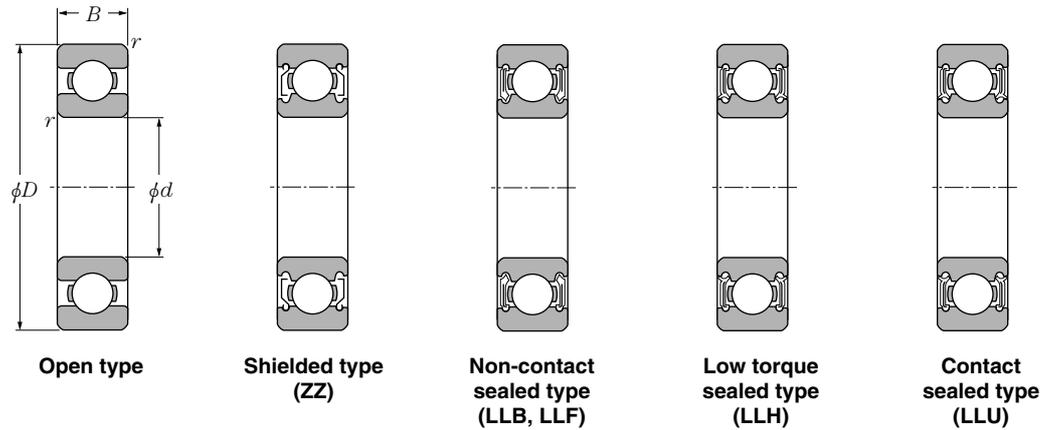

d 10 ~ 20mm

d	Boundary dimensions				Basic load ratings				Factor f_o	Limiting speeds				Bearing numbers				
	mm				kN		kgf			min ⁻¹				open type	shielded type	non-contact sealed type	low torque sealed type	contact sealed type
	D	B	$r_s \min^{1)}$	$r_{NS} \min$	C_r	C_{or}	C_r	C_{or}		grease open type ZZ	oil open type LB	LLH	LLU					
10	15	3	0.1	—	0.855	0.435	87	44	15.7	10 000	12 000	—	—	6700	—	—	—	—
	19	5	0.3	—	1.83	0.925	187	94	14.8	32 000	38 000	—	24 000	6800	ZZ	LLB	—	LLU
	22	6	0.3	0.3	2.7	1.27	275	129	14.0	30 000	36 000	—	21 000	6900	ZZ	LLB	—	LLU
	26	8	0.3	—	4.55	1.96	465	200	12.4	29 000	34 000	25 000	21 000	6000	ZZ	LLB	LLH	LLU
	30	9	0.6	0.5	5.10	2.39	520	244	13.2	25 000	30 000	21 000	18 000	6200	ZZ	LLB	LLH	LLU
	35	11	0.6	0.5	8.20	3.50	835	355	11.4	23 000	27 000	20 000	16 000	6300	ZZ	LLB	LLH	LLU
12	18	4	0.2	—	0.930	0.530	95	54	16.2	8 300	9 500	—	—	6701	—	LLF	—	—
	21	5	0.3	—	1.92	1.04	195	106	15.3	29 000	35 000	—	20 000	6801	ZZ	LLB	—	LLU
	24	6	0.3	0.3	2.89	1.46	295	149	14.5	27 000	32 000	—	19 000	6901	ZZ	LLB	—	LLU
	28	7	0.3	—	5.10	2.39	520	244	13.2	26 000	30 000	—	—	16001	—	—	—	—
	28	8	0.3	—	5.10	2.39	520	244	13.2	26 000	30 000	21 000	18 000	6001	ZZ	LLB	LLH	LLU
	32	10	0.6	0.5	6.10	2.75	620	280	12.7	22 000	26 000	20 000	16 000	6201	ZZ	LLB	LLH	LLU
37	12	1	0.5	9.70	4.20	990	425	11.1	20 000	24 000	19 000	15 000	6301	ZZ	LLB	LLH	LLU	
15	21	4	0.2	—	0.940	0.585	96	59	16.5	6 600	7 600	—	—	6702	—	LLF	—	—
	24	5	0.3	—	2.08	1.26	212	128	15.8	26 000	31 000	—	17 000	6802	ZZ	LLB	—	LLU
	28	7	0.3	0.3	3.65	2.00	375	204	14.8	24 000	28 000	—	16 000	6902	ZZ	LLB	—	LLU
	32	8	0.3	—	5.60	2.83	570	289	13.9	22 000	26 000	—	—	16002	—	—	—	—
	32	9	0.3	0.3	5.60	2.83	570	289	13.9	22 000	26 000	18 000	15 000	6002	ZZ	LLB	LLH	LLU
	35	11	0.6	0.5	7.75	3.60	790	365	12.7	19 000	23 000	18 000	15 000	6202	ZZ	LLB	LLH	LLU
42	13	1	0.5	11.4	5.45	1 170	555	12.3	17 000	21 000	15 000	12 000	6302	ZZ	LLB	LLH	LLU	
17	23	4	0.2	—	1.00	0.660	102	67	16.3	5 000	6 700	—	—	6703	—	LLF	—	—
	26	5	0.3	—	2.23	1.46	227	149	16.1	24 000	28 000	—	15 000	6803	ZZ	LLB	—	LLU
	30	7	0.3	0.3	4.65	2.58	475	263	14.7	22 000	26 000	—	14 000	6903	ZZ	LLB	—	LLU
	35	8	0.3	—	6.80	3.35	695	345	13.6	20 000	24 000	—	—	16003	—	—	—	—
	35	10	0.3	0.3	6.80	3.35	695	345	13.6	20 000	24 000	16 000	14 000	6003	ZZ	LLB	LLH	LLU
	40	12	0.6	0.5	9.60	4.60	980	465	12.8	18 000	21 000	15 000	12 000	6203	ZZ	LLB	LLH	LLU
47	14	1	0.5	13.5	6.55	1 380	665	12.2	16 000	19 000	14 000	11 000	6303	ZZ	LLB	LLH	LLU	
62	17	1.1	—	22.7	10.8	2 320	1 100	11.1	14 000	16 000	—	—	6403	—	—	—	—	
20	27	4	0.2	—	1.04	0.730	106	74	16.1	5 000	5 700	—	—	6704	—	LLF	—	—
	32	7	0.3	0.3	4.00	2.47	410	252	15.5	21 000	25 000	—	13 000	6804	ZZ	LLB	—	LLU
	37	9	0.3	0.3	6.40	3.70	650	375	14.7	19 000	23 000	—	12 000	6904	ZZ	LLB	—	LLU
	42	8	0.3	—	7.90	4.50	810	455	14.5	18 000	21 000	—	—	16004	—	—	—	—
	42	12	0.6	0.5	9.40	5.05	955	515	13.9	18 000	21 000	13 000	11 000	6004	ZZ	LLB	LLH	LLU
	47	14	1	0.5	12.8	6.65	1 310	680	13.2	16 000	18 000	12 000	10 000	6204	ZZ	LLB	LLH	LLU
52	15	1.1	0.5	15.9	7.90	1 620	805	12.4	14 000	17 000	12 000	10 000	6304	ZZ	LLB	LLH	LLU	

1) Smallest allowable dimension for chamfer dimension r.

Deep Groove Ball Bearings

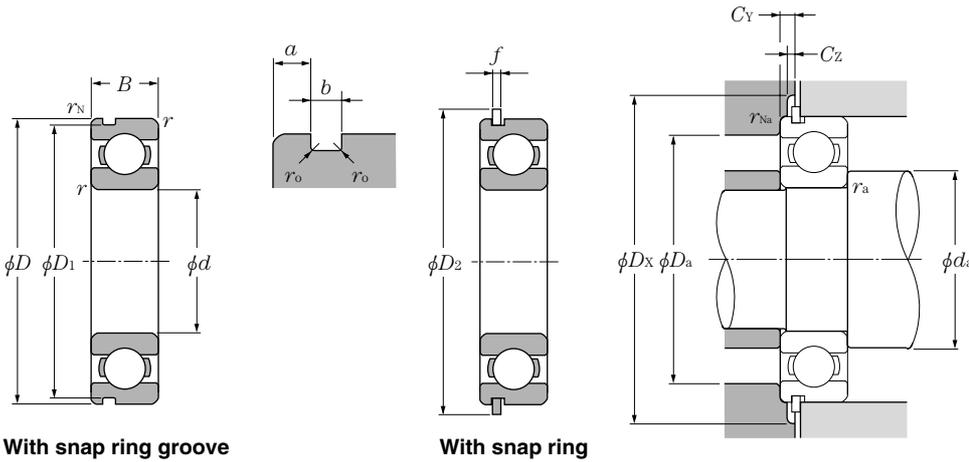

Dynamic equivalent radial load

$$P_r = X F_r + Y F_a$$

$\frac{f_0 \cdot F_a}{C_{or}}$	e	$\frac{F_a}{F_r} \leq e$		$\frac{F_a}{F_r} > e$	
		X	Y	X	Y
0.172	0.19				2.30
0.345	0.22				1.99
0.689	0.26				1.71
1.03	0.28				1.55
1.38	0.30	1	0	0.56	1.45
2.07	0.34				1.31
3.45	0.38				1.15
5.17	0.42				1.04
6.89	0.44				1.00

Static equivalent radial load

$$P_{or} = 0.6 F_r + 0.5 F_a$$

When $P_{or} < F_r$ use $P_{or} = F_r$

Bearing numbers		Snap ring groove dimensions mm				Snap ring dimensions mm		Abutment and fillet dimensions mm								Mass ⁴⁾
snap ring groove	snap ring	D_1 max	a max	b min	r_0 max	D_2 max	f max	d_a min	d_a max ³⁾	D_a max	D_x (approx.)	C_y max	C_z min	r_{as} max	r_{nas} max	kg (approx.)
—	—	—	—	—	—	—	—	10.8	—	14.2	—	—	—	0.1	—	0.0015
—	—	—	—	—	—	—	—	12	12.5	17	—	—	—	0.3	—	0.005
N	NR	20.8	1.05	0.8	0.2	24.8	0.7	12	13	20	25.5	1.5	0.7	0.3	0.3	0.009
— ⁵⁾	— ⁵⁾	—	—	—	—	—	—	12	13.5	24	—	—	—	0.3	—	0.019
N	NR	28.17	2.06	1.35	0.4	34.7	1.12	14	16	26	35.5	2.9	1.2	0.6	0.5	0.032
N	NR	33.17	2.06	1.35	0.4	39.7	1.12	14	17	31	40.5	2.9	1.2	0.6	0.5	0.053
—	—	—	—	—	—	—	—	13.6	13.8	16.4	—	—	—	0.2	—	0.002
—	—	—	—	—	—	—	—	14	14.5	19	—	—	—	0.3	—	0.006
N	NR	22.8	1.05	0.8	0.2	26.8	0.7	14	15	22	27.5	1.5	0.7	0.3	0.3	0.011
—	—	—	—	—	—	—	—	14	—	26	—	—	—	0.3	—	0.019
— ⁵⁾	— ⁵⁾	—	—	—	—	—	—	14	16	26	—	—	—	0.3	—	0.021
N	NR	30.15	2.06	1.35	0.4	36.7	1.12	16	17	28	37.5	2.9	1.2	0.6	0.5	0.037
N	NR	34.77	2.06	1.35	0.4	41.3	1.12	17	18.5	32	42	2.9	1.2	1	0.5	0.06
—	—	—	—	—	—	—	—	16.6	16.8	19.4	—	—	—	0.2	—	0.0025
—	—	—	—	—	—	—	—	17	17.5	22	—	—	—	0.3	—	0.007
N	NR	26.7	1.3	0.95	0.25	30.8	0.85	17	17.5	26	31.5	1.9	0.9	0.3	0.3	0.016
—	—	—	—	—	—	—	—	17	—	30	—	—	—	0.3	—	0.025
N	NR	30.15	2.06	1.35	0.4	36.7	1.12	17	19	30	37.5	2.9	1.2	0.3	0.3	0.03
N	NR	33.17	2.06	1.35	0.4	39.7	1.12	19	20	31	40.5	2.9	1.2	0.6	0.5	0.045
N	NR	39.75	2.06	1.35	0.4	46.3	1.12	20	23	37	47	2.9	1.2	1	0.5	0.082
—	—	—	—	—	—	—	—	18.6	18.8	21.4	—	—	—	0.2	—	0.0025
—	—	—	—	—	—	—	—	19	19.5	24	—	—	—	0.3	—	0.008
N	NR	28.7	1.3	0.95	0.25	32.8	0.85	19	20	28	33.5	1.9	0.9	0.3	0.3	0.018
—	—	—	—	—	—	—	—	19	—	33	—	—	—	0.3	—	0.032
N	NR	33.17	2.06	1.35	0.4	39.7	1.12	19	21	33	40.5	2.9	1.2	0.3	0.3	0.039
N	NR	38.1	2.06	1.35	0.4	44.6	1.12	21	23	36	45.5	2.9	1.2	0.6	0.5	0.066
N	NR	44.6	2.46	1.35	0.4	52.7	1.12	22	25	42	53.5	3.3	1.2	1	0.5	0.115
—	—	—	—	—	—	—	—	23.5	—	55.5	—	—	—	1	—	0.27
—	—	—	—	—	—	—	—	21.6	22.3	25.4	—	—	—	0.2	—	0.0045
N	NR	30.7	1.3	0.95	0.25	34.8	0.85	22	22.5	30	35.5	1.9	0.9	0.3	0.3	0.019
N	NR	35.7	1.7	0.95	0.25	39.8	0.85	22	24	35	40.5	2.3	0.9	0.3	0.3	0.036
—	—	—	—	—	—	—	—	22	—	40	—	—	—	0.3	—	0.051
N	NR	39.75	2.06	1.35	0.4	46.3	1.12	24	26	38	47	2.9	1.2	0.6	0.5	0.069
N	NR	44.6	2.46	1.35	0.4	52.7	1.12	25	28	42	53.5	3.3	1.2	1	0.5	0.106
N	NR	49.73	2.46	1.35	0.4	57.9	1.12	26.5	28.5	45.5	58.5	3.3	1.2	1	0.5	0.144

2) Sealed and shielded bearings are also available. 3) This dimension applies to sealed and shielded bearings. 4) Does not include bearings with snap rings. 5) See page B-40.

Deep Groove Ball Bearings

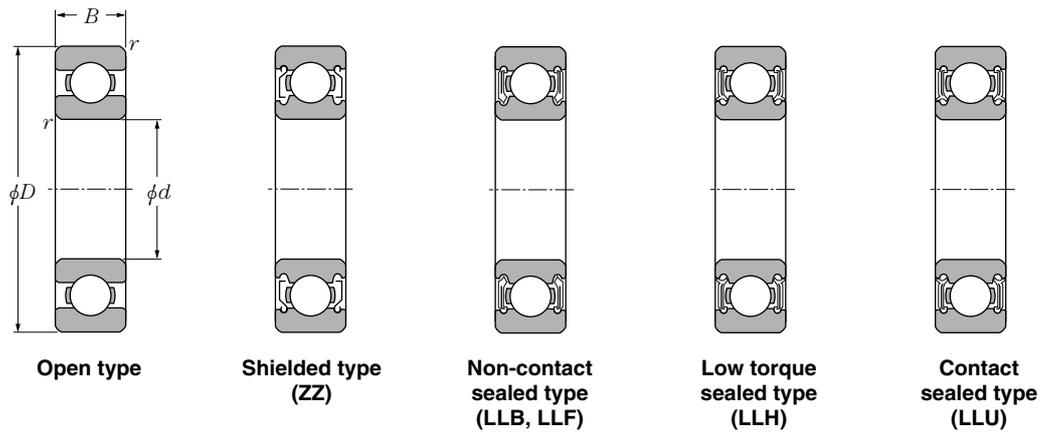

d 20 ~ 35mm

d	Boundary dimensions				Basic load ratings				Factor	Limiting speeds				Bearing numbers					
	mm				dynamic		static			grease	oil		LLH	LLU	open	shielded	non-	low	contact
	D	B	$r_{s \min}^{1)}$	$r_{NS \min}^{1)}$	C_r	C_{or}	C_r	C_{or}			open type	open type							
20	72	19	1.1	—	28.5	13.9	2 900	1 420	11.4	12 000	14 000	—	—	6404	—	—	—	—	
22	44	12	0.6	0.5	9.40	5.05	955	515	13.9	17 000	20 000	13 000	10 000	60/22	ZZ	LLB	LLH	LLU	
	50	14	1	0.5	12.9	6.80	1 320	690	13.5	14 000	17 000	12 000	9 700	62/22	ZZ	LLB	LLH	LLU	
	56	16	1.1	0.5	18.4	9.25	1 880	945	12.4	13 000	15 000	11 000	9 200	63/22	ZZ	LLB	LLH	LLU	
25	32	4	0.2	—	1.10	0.840	112	86	15.8	4 000	4 600	—	—	6705	—	LLF	—	—	
	37	7	0.3	0.3	4.30	2.95	435	300	16.1	18 000	21 000	—	10 000	6805	ZZ	LLB	—	LLU	
	42	9	0.3	0.3	7.05	4.55	715	460	15.4	16 000	19 000	—	9 800	6905	ZZ	LLB	—	LLU	
	47	8	0.3	—	8.35	5.10	855	520	15.1	15 000	18 000	—	—	16005	—	—	—	—	
	47	12	0.6	0.5	10.1	5.85	1 030	595	14.5	15 000	18 000	11 000	9 400	6005	ZZ	LLB	LLH	LLU	
	52	15	1	0.5	14.0	7.85	1 430	800	13.9	13 000	15 000	11 000	8 900	6205	ZZ	LLB	LLH	LLU	
	62	17	1.1	0.5	21.2	10.9	2 160	1 110	12.6	12 000	14 000	9 700	8 100	6305	ZZ	LLB	LLH	LLU	
80	21	1.5	—	34.5	17.5	3 550	1 780	11.6	10 000	12 000	—	—	6405	—	—	—	—		
28	52	12	0.6	0.5	12.5	7.40	1 270	755	14.5	14 000	16 000	10 000	8 400	60/28	ZZ	LLB	LLH	LLU	
	58	16	1	0.5	17.9	9.75	1 830	995	13.4	12 000	14 000	9 700	8 100	62/28	ZZ	LLB	LLH	LLU	
	68	18	1.1	0.5	26.7	14.0	2 730	1 430	12.4	11 000	13 000	8 900	7 400	63/28	ZZ	LLB	LLH	LLU	
30	37	4	0.2	—	1.14	0.950	117	97	15.7	3 300	3 800	—	—	6706	—	LLF	—	—	
	42	7	0.3	0.3	4.70	3.65	480	370	16.5	15 000	18 000	—	8 800	6806	ZZ	LLB	—	LLU	
	47	9	0.3	0.3	7.25	5.00	740	510	15.8	14 000	17 000	—	8 400	6906	ZZ	LLB	—	LLU	
	55	9	0.3	—	11.2	7.35	1 150	750	15.2	13 000	15 000	—	—	16006	—	—	—	—	
	55	13	1	0.5	13.2	8.3	1 350	845	14.8	13 000	15 000	9 200	7 700	6006	ZZ	LLB	LLH	LLU	
	62	16	1	0.5	19.5	11.3	1 980	1 150	13.8	11 000	13 000	8 800	7 300	6206	ZZ	LLB	LLH	LLU	
	72	19	1.1	0.5	26.7	15.0	2 720	1 530	13.3	10 000	12 000	7 900	6 600	6306	ZZ	LLB	LLH	LLU	
90	23	1.5	—	43.5	23.9	4 400	2 440	12.3	8 800	10 000	—	—	6406	—	—	—	—		
32	58	13	1	0.5	11.8	8.05	1 200	820	15.4	12 000	15 000	8 700	7 200	60/32	ZZ	LLB	LLH	LLU	
	65	17	1	0.5	20.7	11.6	2 110	1 190	13.6	11 000	12 000	8 400	7 100	62/32	ZZ	LLB	LLH	LLU	
	75	20	1.1	0.5	29.8	16.9	3 050	1 730	13.1	9 500	11 000	7 700	6 500	63/32	ZZ	LLB	LLH	LLU	
35	47	7	0.3	0.3	4.90	4.05	500	410	16.4	13 000	16 000	—	7 600	6807	ZZ	LLB	—	LLU	
	55	10	0.6	0.5	9.55	6.85	975	695	15.8	12 000	15 000	—	7 100	6907	ZZ	LLB	—	LLU	
	62	9	0.3	—	11.7	8.20	1 190	835	15.6	12 000	14 000	—	—	16007	—	—	—	—	
	62	14	1	0.5	16.0	10.3	1 630	1 050	14.8	12 000	14 000	8 200	6 800	6007	ZZ	LLB	LLH	LLU	
	72	17	1.1	0.5	25.7	15.3	2 620	1 560	13.8	9 800	11 000	7 600	6 300	6207	ZZ	LLB	LLH	LLU	
	80	21	1.5	0.5	33.5	19.1	3 400	1 950	13.1	8 800	10 000	7 300	6 000	6307	ZZ	LLB	LLH	LLU	
100	25	1.5	—	55.0	31.0	5 600	3 150	12.3	7 800	9 100	—	—	6407	—	—	—	—		

1) Smallest allowable dimension for chamfer dimension r.

Deep Groove Ball Bearings

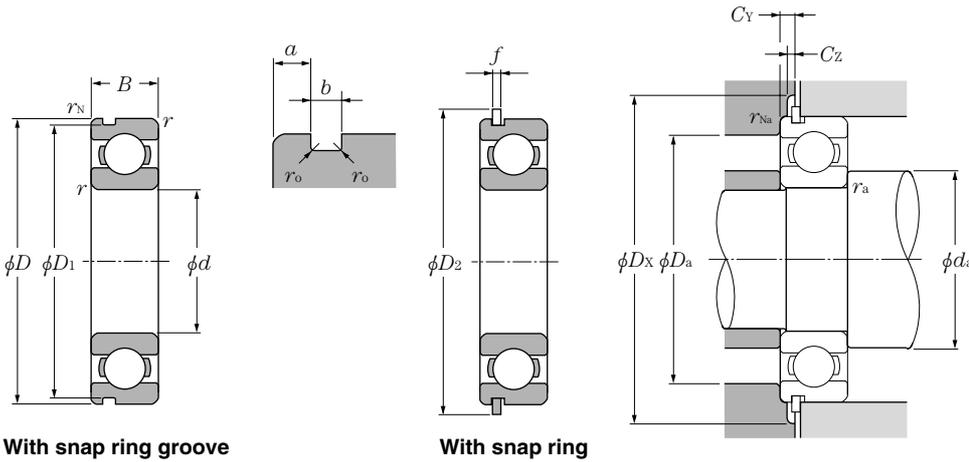

Dynamic equivalent radial load

$$P_r = X F_r + Y F_a$$

$\frac{f_0 \cdot F_a}{C_{or}}$	e	$\frac{F_a}{F_r} \leq e$		$\frac{F_a}{F_r} > e$	
		X	Y	X	Y
0.172	0.19				2.30
0.345	0.22				1.99
0.689	0.26				1.71
1.03	0.28				1.55
1.38	0.30	1	0	0.56	1.45
2.07	0.34				1.31
3.45	0.38				1.15
5.17	0.42				1.04
6.89	0.44				1.00

Static equivalent radial load

$$P_{or} = 0.6 F_r + 0.5 F_a$$

When $P_{or} < F_r$ use $P_{or} = F_r$

Bearing numbers		Snap ring groove dimensions mm				Snap ring dimensions mm		Abutment and fillet dimensions mm								Mass ⁴⁾
snap ring groove	snap ring	D ₁ max	a max	b min	r ₀ max	D ₂ max	f max	d _a min	d _a max ³⁾	D _a max	D _X (approx.)	C _Y max	C _Z min	r _{as} max	r _{Nas} max	kg (approx.)
—	—	—	—	—	—	—	—	26.5	—	65.5	—	—	—	1	—	0.4
N	NR	41.75	2.06	1.35	0.4	48.3	1.12	26	26.5	40	49	2.9	1.2	0.6	0.5	0.074
N	NR	47.6	2.46	1.35	0.4	55.7	1.12	27	29.5	45	56.5	3.3	1.2	1	0.5	0.117
N	NR	53.6	2.46	1.35	0.4	61.7	1.12	28.5	31	49.5	62.5	3.3	1.2	1	0.5	0.176
—	—	—	—	—	—	—	—	26.6	27.3	30.4	—	—	—	0.2	—	0.005
N	NR	35.7	1.3	0.95	0.25	39.8	0.85	27	28	35	40.5	1.9	0.9	0.3	0.3	0.022
N	NR	40.7	1.7	0.95	0.25	44.8	0.85	27	29	40	45.5	2.3	0.9	0.3	0.3	0.042
—	—	—	—	—	—	—	—	27	—	45.0	—	—	—	0.3	—	0.06
N	NR	44.6	2.06	1.35	0.4	52.7	1.12	29	30.5	43	53.5	2.9	1.2	0.6	0.5	0.08
N	NR	49.73	2.46	1.35	0.4	57.9	1.12	30	32	47	58.5	3.3	1.2	1	0.5	0.128
N	NR	59.61	3.28	1.9	0.6	67.7	1.7	31.5	35	55.5	68.5	4.6	1.7	1	0.5	0.232
—	—	—	—	—	—	—	—	33	—	72	—	—	—	1.5	—	0.53
N	NR	49.73	2.06	1.35	0.4	57.9	1.12	32	34	48	58.5	2.9	1.2	0.6	0.5	0.098
N	NR	55.6	2.46	1.35	0.4	63.7	1.12	33	35.5	53	64.5	3.3	1.2	1	0.5	0.171
N	NR	64.82	3.28	1.9	0.6	74.6	1.7	34.5	38.5	61.5	76	4.6	1.7	1	0.5	0.284
—	—	—	—	—	—	—	—	31.6	32.3	35.4	—	—	—	0.2	—	0.006
N	NR	40.7	1.3	0.95	0.25	44.8	0.85	32	33	40	45.5	1.9	0.9	0.3	0.3	0.026
N	NR	45.7	1.7	0.95	0.25	49.8	0.85	32	34	45	50.5	2.3	0.9	0.3	0.3	0.048
—	—	—	—	—	—	—	—	32	—	53	—	—	—	0.3	—	0.091
N	NR	52.6	2.08	1.35	0.4	60.7	1.12	35	37	50	61.5	2.9	1.2	1	0.5	0.116
N	NR	59.61	3.28	1.9	0.6	67.7	1.7	35	39	57	68.5	4.6	1.7	1	0.5	0.199
N	NR	68.81	3.28	1.9	0.6	78.6	1.7	36.5	43	65.5	80	4.6	1.7	1	0.5	0.36
—	—	—	—	—	—	—	—	38	—	82	—	—	—	1.5	—	0.735
N	NR	55.6	2.08	1.35	0.4	63.7	1.12	37	39	53	64.5	2.9	1.2	1	0.5	0.129
N	NR	62.6	3.28	1.9	0.6	70.7	1.7	37	40	60	71.5	4.6	1.7	1	0.5	0.226
N	NR	71.83	3.28	1.9	0.6	81.6	1.7	38.5	43.5	68.5	83	4.6	1.7	1	0.5	0.382
N	NR	45.7	1.3	0.95	0.25	49.8	0.85	37	38	45	50.5	1.9	0.9	0.3	0.3	0.029
N	NR	53.7	1.7	0.95	0.25	57.8	0.85	39	40	51	58.5	2.3	0.9	0.6	0.5	0.074
—	—	—	—	—	—	—	—	37	—	60	—	—	—	0.3	—	0.11
N	NR	59.61	2.08	1.9	0.6	67.7	1.7	40	42	57	68.5	3.4	1.7	1	0.5	0.155
N	NR	68.81	3.28	1.9	0.6	78.6	1.7	41.5	45	65.5	80	4.6	1.7	1	0.5	0.288
N	NR	76.81	3.28	1.9	0.6	86.6	1.7	43	47	72	88	4.6	1.7	1.5	0.5	0.457
—	—	—	—	—	—	—	—	43	—	92	—	—	—	1.5	—	0.952

2) Sealed and shielded bearings are also available.

3) This dimension applies to sealed and shielded bearings.

4) Does not include bearings with snap rings.

Deep Groove Ball Bearings

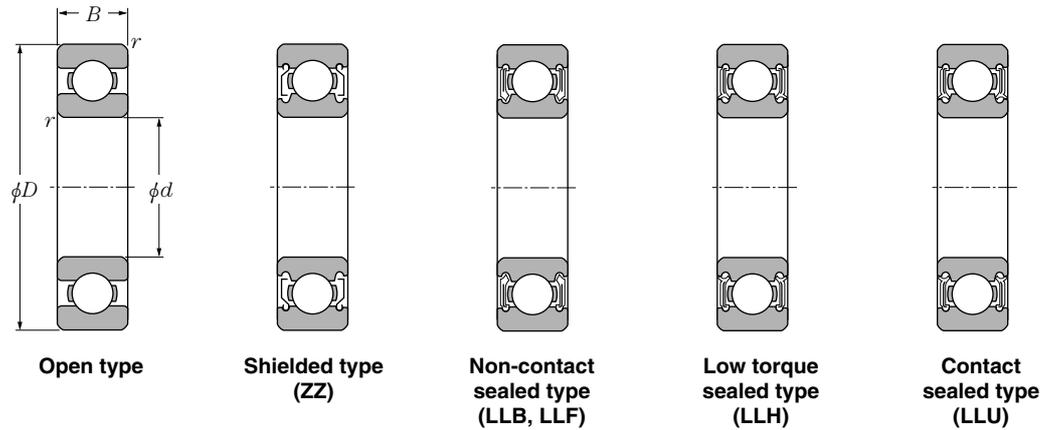

d 40 ~ 60mm

d	Boundary dimensions				Basic load ratings				Factor	Limiting speeds				Bearing numbers					
	mm				kN		kgf			grease open type ZZ	oil open type		LLH	LLU	open type	shielded type	non-contact sealed type	low torque sealed type	contact sealed type
	D	B	$r_s \min^{1)}$	$r_{NS} \min$	C_r	C_{or}	C_r	C_{or}			Z	LB							
40	52	7	0.3	0.3	5.10	4.40	520	445	16.3	12 000	14 000	—	6 700	6808	ZZ	LLB	—	LLU	
	62	12	0.6	0.5	12.2	8.90	1 240	910	15.8	11 000	13 000	—	6 300	6908	ZZ	LLB	—	LLU	
	68	9	0.3	—	12.6	9.65	1 290	985	16.0	10 000	12 000	—	—	16008	—	—	—	—	
	68	15	1	0.5	16.8	11.5	1 710	1 170	15.2	10 000	12 000	7 300	6 100	6008	ZZ	LLB	LLH	LLU	
	80	18	1.1	0.5	29.1	17.8	2 970	1 820	14.0	8 700	10 000	6 700	5 600	6208	ZZ	LLB	LLH	LLU	
	90	23	1.5	0.5	40.5	24.0	4 150	2 450	13.2	7 800	9 200	6 400	5 300	6308	ZZ	LLB	LLH	LLU	
	110	27	2	—	63.5	36.5	6 500	3 750	12.3	7 000	8 200	—	—	6408	—	—	—	—	
45	58	7	0.3	0.3	5.35	4.95	550	500	16.1	11 000	12 000	—	5 900	6809	ZZ	LLB	—	LLU	
	68	12	0.6	0.5	13.1	10.4	1 330	1 060	16.1	9 800	12 000	—	5 600	6909	ZZ	LLB	—	LLU	
	75	10	0.6	—	12.9	10.5	1 320	1 070	16.2	9 200	11 000	—	—	16009	—	—	—	—	
	75	16	1	0.5	21.0	15.1	2 140	1 540	15.3	9 200	11 000	6 500	5 400	6009	ZZ	LLB	LLH	LLU	
	85	19	1.1	0.5	32.5	20.4	3 350	2 080	14.1	7 800	9 200	6 200	5 200	6209	ZZ	LLB	LLH	LLU	
	100	25	1.5	0.5	53.0	32.0	5 400	3 250	13.1	7 000	8 200	5 600	4 700	6309	ZZ	LLB	LLH	LLU	
	120	29	2	—	77.0	45.0	7 850	4 600	12.1	6 300	7 400	—	—	6409	—	—	—	—	
50	65	7	0.3	0.3	6.60	6.10	670	620	16.1	9 600	11 000	—	5 300	6810	ZZ	LLB	—	LLU	
	72	12	0.6	0.5	13.4	11.2	1 370	1 140	16.3	8 900	11 000	—	5 100	6910	ZZ	LLB	—	LLU	
	80	10	0.6	—	13.2	11.3	1 350	1 150	16.4	8 400	9 800	—	—	16010	—	—	—	—	
	80	16	1	0.5	21.8	16.6	2 230	1 690	15.5	8 400	9 800	6 000	5 000	6010	ZZ	LLB	LLH	LLU	
	90	20	1.1	0.5	35.0	23.2	3 600	2 370	14.4	7 100	8 300	5 700	4 700	6210	ZZ	LLB	LLH	LLU	
	110	27	2	0.5	62.0	38.5	6 300	3 900	13.2	6 400	7 500	5 000	4 200	6310	ZZ	LLB	LLH	LLU	
	130	31	2.1	—	83.0	49.5	8 450	5 050	12.5	5 700	6 700	—	—	6410	—	—	—	—	
55	72	9	0.3	0.3	8.80	8.10	900	825	16.2	8 700	10 000	—	4 800	6811	ZZ	LLB	—	LLU	
	80	13	1	0.5	16.0	13.3	1 630	1 350	16.2	8 200	9 600	—	4 600	6911	ZZ	LLB	—	LLU	
	90	11	0.6	—	18.6	15.3	1 900	1 560	16.2	7 700	9 000	—	—	16011	—	—	—	—	
	90	18	1.1	0.5	28.3	21.2	2 880	2 170	15.3	7 700	9 000	—	4 500	6011	ZZ	LLB	—	LLU	
	100	21	1.5	0.5	43.5	29.2	4 450	2 980	14.3	6 400	7 600	—	4 300	6211	ZZ	LLB	—	LLU	
	120	29	2	0.5	71.5	45.0	7 300	4 600	13.2	5 800	6 800	—	3 900	6311	ZZ	LLB	—	LLU	
	140	33	2.1	—	89.0	54.0	9 050	5 500	12.7	5 200	6 100	—	—	6411	—	—	—	—	
60	78	10	0.3	0.3	11.5	10.6	1 170	1 080	16.3	8 000	9 400	—	4 400	6812	ZZ	LLB	—	LLU	
	85	13	1	0.5	16.4	14.3	1 670	1 450	16.4	7 600	8 900	—	4 300	6912	ZZ	LLB	—	LLU	
	95	11	0.6	—	20.0	17.5	2 040	1 780	16.3	7 000	8 300	—	—	16012	—	—	—	—	
	95	18	1.1	0.5	29.5	23.2	3 000	2 370	15.6	7 000	8 300	—	4 100	6012	ZZ	LLB	—	LLU	
	110	22	1.5	0.5	52.5	36.0	5 350	3 700	14.3	6 000	7 000	—	3 800	6212	ZZ	LLB	—	LLU	
	130	31	2.1	0.5	82.0	52.0	8 350	5 300	13.2	5 400	6 300	—	3 600	6312	ZZ	LLB	—	LLU	
	150	35	2.1	—	102	64.5	10 400	6 550	12.6	4 800	5 700	—	—	6412	—	—	—	—	

1) Smallest allowable dimension for chamfer dimension r.

Deep Groove Ball Bearings

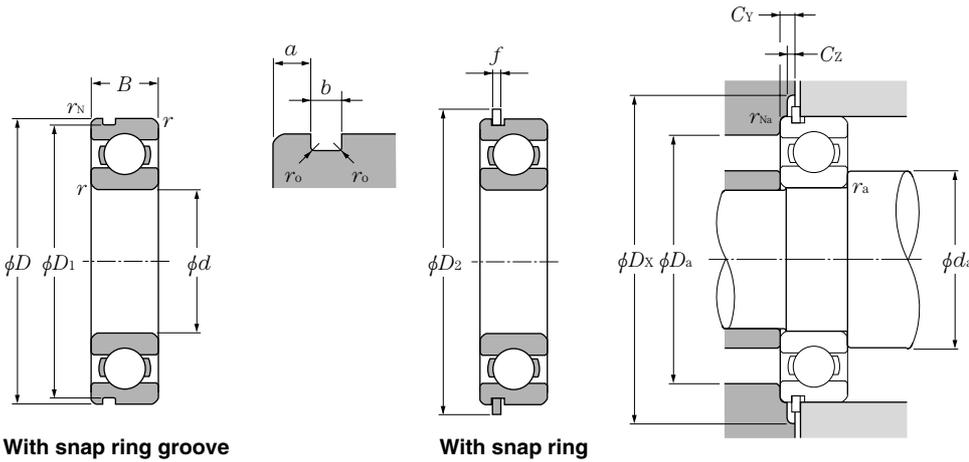

Dynamic equivalent radial load

$$P_r = X F_r + Y F_a$$

$\frac{f_0 \cdot F_a}{C_{or}}$	e	$\frac{F_a}{F_r} \leq e$		$\frac{F_a}{F_r} > e$	
		X	Y	X	Y
0.172	0.19				2.30
0.345	0.22				1.99
0.689	0.26				1.71
1.03	0.28				1.55
1.38	0.30	1	0	0.56	1.45
2.07	0.34				1.31
3.45	0.38				1.15
5.17	0.42				1.04
6.89	0.44				1.00

Static equivalent radial load

$$P_{or} = 0.6 F_r + 0.5 F_a$$

When $P_{or} < F_r$ use $P_{or} = F_r$

Bearing numbers		Snap ring groove dimensions mm				Snap ring dimensions mm		Abutment and fillet dimensions mm								Mass ⁴⁾
snap ring groove	snap ring	D ₁ max	a max	b min	r ₀ max	D ₂ max	f max	d _a min	d _a max ³⁾	D _a max	D _X (approx.)	C _Y max	C _Z min	r _{as} max	r _{Nas} max	kg (approx.)
N	NR	50.7	1.3	0.95	0.25	54.8	0.85	42	43	50	55.5	1.9	0.9	0.3	0.3	0.033
N	NR	60.7	1.7	0.95	0.25	64.8	0.85	44	45	58	65.5	2.3	0.9	0.6	0.5	0.11
—	—	—	—	—	—	—	—	42	—	66	—	—	—	0.3	—	0.125
N	NR	64.82	2.49	1.9	0.6	74.6	1.7	45	47	63	76	3.8	1.7	1	0.5	0.19
N	NR	76.81	3.28	1.9	0.6	86.6	1.7	46.5	51	73.5	88	4.6	1.7	1	0.5	0.366
N	NR	86.79	3.28	2.7	0.6	96.5	2.46	48	54	82	98	5.4	2.5	1.5	0.5	0.63
—	—	—	—	—	—	—	—	49	—	101	—	—	—	2.0	—	1.23
N	NR	56.7	1.3	0.95	0.25	60.8	0.85	47	48	56	61.5	1.9	0.9	0.3	0.3	0.04
N	NR	66.7	1.7	0.95	0.25	70.8	0.85	49	51	64	72	2.3	0.9	0.6	0.5	0.128
—	—	—	—	—	—	—	—	49	—	71	—	—	—	0.6	—	0.171
N	NR	71.83	2.49	1.9	0.6	81.6	1.7	50	52.5	70	83	3.8	1.7	1	0.5	0.237
N	NR	81.81	3.28	1.9	0.6	91.6	1.7	51.5	55.5	78.5	93	4.6	1.7	1	0.5	0.398
N	NR	96.8	3.28	2.7	0.6	106.5	2.46	53	61.5	92	108	5.4	2.5	1.5	0.5	0.814
—	—	—	—	—	—	—	—	54	—	111	—	—	—	2	—	1.53
N	NR	63.7	1.3	0.95	0.25	67.8	0.85	52	54	63	68.5	1.9	0.9	0.3	0.3	0.052
N	NR	70.7	1.7	0.95	0.25	74.8	0.85	54	55.5	68	76	2.3	0.9	0.6	0.5	0.132
—	—	—	—	—	—	—	—	54	—	76	—	—	—	0.6	—	0.18
N	NR	76.81	2.49	1.9	0.6	86.6	1.7	55	57.5	75	88	3.8	1.7	1	0.5	0.261
N	NR	86.79	3.28	2.7	0.6	96.5	2.46	56.5	60	83.5	98	5.4	2.5	1	0.5	0.454
N	NR	106.81	3.28	2.7	0.6	116.6	2.46	59	68.5	101	118	5.4	2.5	2	0.5	1.07
—	—	—	—	—	—	—	—	61	—	119	—	—	—	2	—	1.88
N	NR	70.7	1.7	0.95	0.25	74.8	0.85	57	59	70	76	2.3	0.9	0.3	0.3	0.083
N	NR	77.9	2.1	1.3	0.4	84.4	1.12	60	61.5	75	86	2.9	1.2	1	0.5	0.18
—	—	—	—	—	—	—	—	59	—	86	—	—	—	0.6	—	0.258
N	NR	86.79	2.87	2.7	0.6	96.5	2.46	61.5	64	83.5	98	5	2.5	1	0.5	0.388
N	NR	96.8	3.28	2.7	0.6	106.5	2.46	63	67	92	108	5.4	2.5	1.5	0.5	0.601
N	NR	115.21	4.06	3.1	0.6	129.7	2.82	64	74	111	131.5	6.5	2.9	2	0.5	1.37
—	—	—	—	—	—	—	—	66	—	129	—	—	—	2	—	2.29
N	NR	76.2	1.7	1.3	0.4	82.7	1.12	62	64.5	76	84	2.5	1.2	0.3	0.3	0.106
N	NR	82.9	2.1	1.3	0.4	89.4	1.12	65	66.5	80	91	2.9	1.2	1	0.5	0.193
—	—	—	—	—	—	—	—	64	—	91	—	—	—	0.6	—	0.283
N	NR	91.82	2.87	2.7	0.6	101.6	2.46	66.5	69	88.5	103	5	2.5	1	0.5	0.414
N	NR	106.81	3.28	2.7	0.6	116.6	2.46	68	75	102	118	5.4	2.5	1.5	0.5	0.783
N	NR	125.22	4.06	3.1	0.6	139.7	2.82	71	80.5	119	141.5	6.5	2.9	2	0.5	1.73
—	—	—	—	—	—	—	—	71	—	139	—	—	—	2	—	2.77

2) Sealed and shielded bearings are also available.

3) This dimension applies to sealed and shielded bearings.

4) Does not include bearings with snap rings.

Deep Groove Ball Bearings

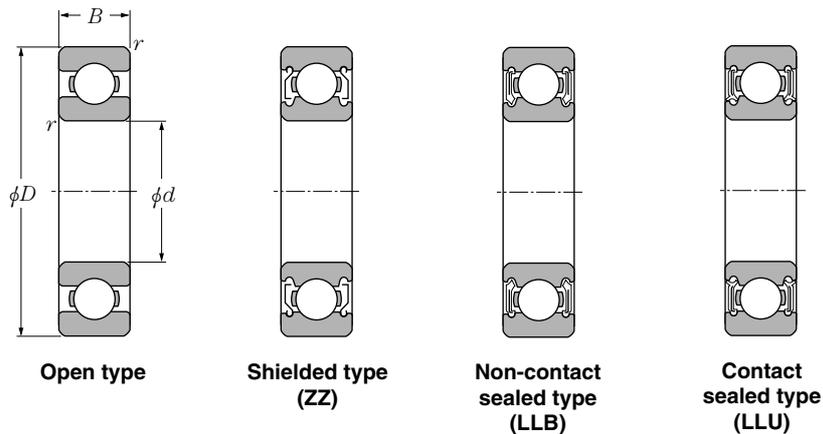

d 65 ~ 85mm

d	Boundary dimensions				Basic load ratings				Factor f_0	Limiting speeds			Bearing numbers			
	mm				dynamic		static			grease open type	min ⁻¹ oil		open type	non- contact shielded type	low- torque sealed type	contact sealed type
	D	B	$r_{s\ min}^{1)}$	$r_{NS\ min}$	C_r	C_{or}	C_r	C_{or}			ZZ	LLB				
65	85	10	0.6	0.5	11.6	11.0	1 180	1 120	16.2	7 400	8 700	4 100	6813	ZZ	LLB	LLU
	90	13	1	0.5	17.4	16.1	1 770	1 640	16.6	7 000	8 200	4 000	6913	ZZ	LLB	LLU
	100	11	0.6	—	20.5	18.7	2 090	1 910	16.5	6 500	7 700	—	16013	—	—	—
	100	18	1.1	0.5	30.5	25.2	3 100	2 570	15.8	6 500	7 700	3 900	6013	ZZ	LLB	LLU
	120	23	1.5	0.5	57.5	40.0	5 850	4 100	14.4	5 500	6 500	3 600	6213	ZZ	LLB	LLU
	140	33	2.1	0.5	92.5	60.0	9 450	6 100	13.2	4 900	5 800	3 300	6313	ZZ	LLB	LLU
	160	37	2.1	—	111	72.5	11 300	7 400	12.7	4 400	5 200	—	6413	—	—	—
70	90	10	0.6	0.5	12.1	11.9	1 230	1 220	16.1	6 900	8 100	3 800	6814	ZZ	LLB	LLU
	100	16	1	0.5	23.7	21.2	2 420	2 160	16.3	6 500	7 700	3 700	6914	ZZ	LLB	LLU
	110	13	0.6	—	24.4	22.6	2 480	2 300	16.5	6 100	7 100	—	16014	—	—	—
	110	20	1.1	0.5	38.0	31.0	3 900	3 150	15.6	6 100	7 100	3 600	6014	ZZ	LLB	LLU
	125	24	1.5	0.5	62.0	44.0	6 350	4 500	14.5	5 100	6 000	3 400	6214	ZZ	LLB	LLU
	150	35	2.1	0.5	104	68.0	10 600	6 950	13.2	4 600	5 400	3 100	6314	ZZ	LLB	LLU
	180	42	3	—	128	89.5	13 100	9 100	12.7	4 100	4 800	—	6414	—	—	—
75	95	10	0.6	0.5	12.5	12.9	1 280	1 310	16.0	6 400	7 600	3 600	6815	ZZ	LLB	LLU
	105	16	1	0.5	24.4	22.6	2 480	2 300	16.5	6 100	7 200	3 500	6915	ZZ	LLB	LLU
	115	13	0.6	—	25.0	24.0	2 540	2 450	16.6	5 700	6 700	—	16015	—	—	—
	115	20	1.1	0.5	39.5	33.5	4 050	3 400	15.8	5 700	6 700	3 300	6015	ZZ	LLB	LLU
	130	25	1.5	0.5	66.0	49.5	6 750	5 050	14.7	4 800	5 600	3 200	6215	ZZ	LLB	LLU
	160	37	2.1	0.5	113	77.0	11 600	7 850	13.2	4 300	5 000	2 900	6315	ZZ	LLB	LLU
	190	45	3	—	138	99.0	14 000	10 100	12.7	3 800	4 500	—	6415	—	—	—
80	100	10	0.6	0.5	12.7	13.3	1 290	1 360	16.0	6 000	7 100	3 400	6816	ZZ	LLB	LLU
	110	16	1	0.5	24.9	24.0	2 540	2 450	16.6	5 700	6 700	3 200	6916	ZZ	LLB	LLU
	125	14	0.6	—	25.4	25.1	2 590	2 560	16.4	5 300	6 200	—	16016	—	—	—
	125	22	1.1	0.5	47.5	40.0	4 850	4 050	15.6	5 300	6 200	3 100	6016	ZZ	LLB	LLU
	140	26	2	0.5	72.5	53.0	7 400	5 400	14.6	4 500	5 300	3 000	6216	ZZ	LLB	LLU
	170	39	2.1	0.5	123	86.5	12 500	8 850	13.3	4 000	4 700	2 700	6316	ZZ	LLB	LLU
	200	48	3	—	164	125	16 700	12 800	12.3	3 600	4 200	—	6416	—	—	—
85	110	13	1	0.5	18.7	19.0	1 910	1 940	16.2	5 700	6 700	3 100	6817	ZZ	LLB	LLU
	120	18	1.1	0.5	32.0	29.6	3 250	3 000	16.4	5 400	6 300	3 000	6917	ZZ	LLB	LLU
	130	14	0.6	—	25.9	26.2	2 640	2 670	16.4	5 000	5 900	—	16017	—	—	—
	130	22	1.1	0.5	49.5	43.0	5 050	4 400	15.8	5 000	5 900	2 900	6017	ZZ	LLB	LLU
	150	28	2	0.5	83.5	64.0	8 500	6 500	14.7	4 200	5 000	2 800	6217	ZZ	LLB	LLU
	180	41	3	0.5	133	97.0	13 500	9 850	13.3	3 800	4 500	2 600	6317	ZZ	LLB	LLU

1) Smallest allowable dimension for chamfer dimension r.

Deep Groove Ball Bearings

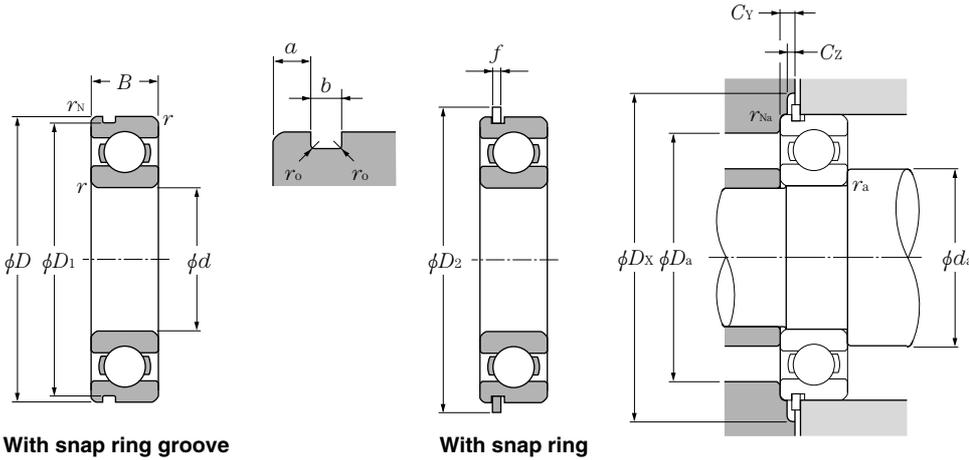

Dynamic equivalent radial load

$$P_r = X F_r + Y F_a$$

$\frac{f_0 \cdot F_a}{C_{or}}$	e	$\frac{F_a}{F_r} \leq e$		$\frac{F_a}{F_r} > e$	
		X	Y	X	Y
0.172	0.19				2.30
0.345	0.22				1.99
0.689	0.26				1.71
1.03	0.28				1.55
1.38	0.30	1	0	0.56	1.45
2.07	0.34				1.31
3.45	0.38				1.15
5.17	0.42				1.04
6.89	0.44				1.00

Static equivalent radial load

$$P_{or} = 0.6 F_r + 0.5 F_a$$

When $P_{or} < F_r$ use $P_{or} = F_r$

Bearing numbers		Snap ring groove dimensions mm				Snap ring dimensions mm		Abutment and fillet dimensions mm							Mass ⁴⁾	
snap ring groove ²⁾	snap ring ²⁾	D ₁ max	a max	b min	r ₀ max	D ₂ max	f max	d _a min	d _a max ³⁾	D _a max	D _x (approx.)	C _Y max	C _Z min	r _{as} max	r _{Nas} max	kg (approx.)
N	NR	82.9	1.7	1.3	0.4	89.4	1.12	69	70	81	91	2.5	1.2	0.6	0.5	0.128
N	NR	87.9	2.1	1.3	0.4	94.4	1.12	70	71.5	85	96	2.9	1.2	1	0.5	0.206
—	—	—	—	—	—	—	—	69	—	96	—	—	—	0.6	—	0.307
N	NR	96.8	2.87	2.7	0.6	106.5	2.46	71.5	74	93.5	108	5	2.5	1	0.5	0.421
N	NR	115.21	4.06	3.1	0.6	129.7	2.82	73	80.5	112	131.5	6.5	2.9	1.5	0.5	0.99
N	NR	135.23	4.9	3.1	0.6	149.7	2.82	76	86	129	152	7.3	2.9	2	0.5	2.08
—	—	—	—	—	—	—	—	76	—	149	—	—	—	2	—	3.3
N	NR	87.9	1.7	1.3	0.4	94.4	1.12	74	75.5	86	96	2.5	1.2	0.6	0.5	0.137
N	NR	97.9	2.5	1.3	0.4	104.4	1.12	75	77.5	95	106	3.3	1.2	1	0.5	0.334
—	—	—	—	—	—	—	—	74	—	106	—	—	—	0.6	—	0.441
N	NR	106.81	2.87	2.7	0.6	116.6	2.46	76.5	80.5	103.5	118	5	2.5	1	0.5	0.604
N	NR	120.22	4.06	3.1	0.6	134.7	2.82	78	85	117	136.5	6.5	2.9	1.5	0.5	1.07
N	NR	145.24	4.9	3.1	0.6	159.7	2.82	81	92.5	139	162	7.3	2.9	2	0.5	2.52
—	—	—	—	—	—	—	—	83	—	167	—	—	—	2.5	—	4.83
N	NR	92.9	1.7	1.3	0.4	99.4	1.12	79	80	91	101	2.5	1.2	0.6	0.5	0.145
N	NR	102.6	2.5	1.3	0.4	110.7	1.12	80	82.5	100	112	3.3	1.2	1	0.5	0.353
—	—	—	—	—	—	—	—	79	—	111	—	—	—	0.6	—	0.464
N	NR	111.81	2.87	2.7	0.6	121.6	2.46	81.5	85.5	108.5	123	5	2.5	1	0.5	0.649
N	NR	125.22	4.06	3.1	0.6	139.7	2.82	83	90.5	122	141.5	6.5	2.9	1.5	0.5	1.18
N	NR	155.22	4.9	3.1	0.6	169.7	2.82	86	99	149	172	7.3	2.9	2	0.5	3.02
—	—	—	—	—	—	—	—	88	—	177	—	—	—	2.5	—	5.72
N	NR	97.9	1.7	1.3	0.4	104.4	1.12	84	85	96	106	2.5	1.2	0.6	0.5	0.154
N	NR	107.6	2.5	1.3	0.4	115.7	1.12	85	88	105	117	3.3	1.2	1	0.5	0.373
—	—	—	—	—	—	—	—	84	—	121	—	—	—	0.6	—	0.597
N	NR	120.22	2.87	3.1	0.6	134.7	2.82	86.5	91.5	118.5	136.5	5.3	2.9	1	0.5	0.854
N	NR	135.23	4.9	3.1	0.6	149.7	2.82	89	95.5	131	152	7.3	2.9	2	0.5	1.4
N	NR	163.65	5.69	3.5	0.6	182.9	3.1	91	105	159	185	8.4	3.1	2	0.5	3.59
—	—	—	—	—	—	—	—	93	—	187	—	—	—	2.5	—	6.76
N	NR	107.6	2.1	1.3	0.4	115.7	1.12	90	91	105	117	2.9	1.2	1	0.5	0.27
N	NR	117.6	3.3	1.3	0.4	125.7	1.12	91.5	94	113.5	127	4.1	1.2	1	0.5	0.536
—	—	—	—	—	—	—	—	89	—	126	—	—	—	0.6	—	0.626
N	NR	125.22	2.87	3.1	0.6	139.7	2.82	91.5	97	123.5	141.5	5.3	2.9	1	0.5	0.89
N	NR	145.24	4.9	3.1	0.6	159.7	2.82	94	103	141	162	7.3	2.9	2	0.5	1.79
N	NR	173.66	5.69	3.5	0.6	192.9	3.1	98	112	167	195	8.4	3.1	2.5	0.5	4.23

2) Sealed and shielded bearings are also available.

3) This dimension applies to sealed and shielded bearings.

4) Does not include bearings with snap rings.

Deep Groove Ball Bearings

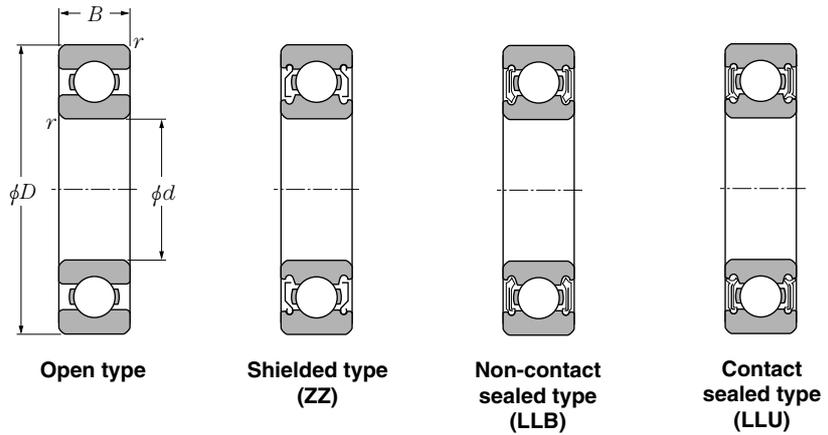

d 90 ~ 120mm

	Boundary dimensions				Basic load ratings				Factor	Limiting speeds			Bearing numbers			
	mm				dynamic		static			f_0	min ⁻¹		open type	non-contact shielded type	low-torque sealed type	contact sealed type
	d	D	B	$r_{s \min}^{1)}$	$r_{NS \min}$	C_r	C_{or}	C_r	C_{or}		grease open type	oil open type				
90	115	13	1	0.5	19.0	19.7	1 940	2 010	16.1	5 400	6 300	3 000	6818	ZZ	LLB	LLU
	125	18	1.1	0.5	33.0	31.5	3 350	3 200	16.5	5 100	6 000	2 900	6918	ZZ	LLB	LLU
	140	16	1	—	33.5	33.5	3 400	3 400	16.5	4 700	5 600	—	16018	—	—	—
	140	24	1.5	0.5	58.0	49.5	5 950	5 050	15.6	4 700	5 600	2 800	6018	ZZ	LLB	LLU
	160	30	2	0.5	96.0	71.5	9 800	7 300	14.5	4 000	4 700	2 600	6218	ZZ	LLB	LLU
	190	43	3	0.5	143	107	14 500	10 900	13.3	3 600	4 200	2 400	6318	ZZ	LLB	LLU
95	120	13	1	0.5	19.3	20.5	1 970	2 090	16.1	5 000	5 900	2 800	6819	ZZ	LLB	LLU
	130	18	1.1	0.5	33.5	33.5	3 450	3 400	16.6	4 800	5 700	2 800	6919	ZZ	LLB	LLU
	145	16	1	—	34.5	35.0	3 500	3 550	16.5	4 500	5 300	—	16019	—	—	—
	145	24	1.5	0.5	60.5	54.0	6 150	5 500	15.8	4 500	5 300	2 600	6019	ZZ	LLB	LLU
	170	32	2.1	0.5	109	82.0	11 100	8 350	14.4	3 700	4 400	2 500	6219	ZZ	LLB	LLU
	200	45	3	0.5	153	119	15 600	12 100	13.3	3 300	3 900	2 300	6319	ZZ	—	LLU
100	125	13	1	0.5	19.6	21.2	2 000	2 160	16.0	4 800	5 600	2 700	6820	ZZ	LLB	LLU
	140	20	1.1	0.5	41.0	39.5	4 200	4 050	16.4	4 500	5 300	2 600	6920	ZZ	LLB	LLU
	150	16	1	—	35.0	36.5	3 600	3 750	16.4	4 200	5 000	—	16020	—	—	—
	150	24	1.5	0.5	60.0	54.0	6 150	5 500	15.9	4 200	5 000	2 600	6020	ZZ	LLB	LLU
	180	34	2.1	0.5	122	93.0	12 500	9 450	14.4	3 500	4 200	2 300	6220	ZZ	LLB	LLU
	215	47	3	—	173	141	17 600	14 400	13.2	3 200	3 700	2 200	6320	ZZ	—	LLU
105	130	13	1	0.5	19.8	22.0	2 020	2 240	15.9	4 600	5 400	—	6821	—	—	—
	145	20	1.1	0.5	42.5	42.0	4 300	4 300	16.5	4 300	5 100	2 500	6921	ZZ	LLB	LLU
	160	18	1	—	52.0	50.5	5 300	5 150	16.3	4 000	4 700	—	16021	—	—	—
	160	26	2	0.5	72.5	65.5	7 400	6 700	15.8	4 000	4 700	2 400	6021	ZZ	LLB	LLU
	190	36	2.1	0.5	133	105	13 600	10 700	14.4	3 400	4 000	2 300	6221	ZZ	—	LLU
	225	49	3	—	184	153	18 700	15 700	13.2	3 000	3 600	2 100	6321	ZZ	—	LLU
110	140	16	1	0.5	24.9	28.2	2 540	2 880	16.0	4 300	5 100	—	6822	—	—	—
	150	20	1.1	0.5	43.5	44.5	4 450	4 550	16.6	4 100	4 800	2 400	6922	ZZ	LLB	LLU
	170	19	1	—	57.5	56.5	5 850	5 800	16.3	3 800	4 500	—	16022	—	—	—
	170	28	2	0.5	82.0	73.0	8 350	7 450	15.6	3 800	4 500	2 300	6022	ZZ	LLB	LLU
	200	38	2.1	0.5	144	117	14 700	11 900	14.3	3 200	3 800	2 200	6222	ZZ	—	LLU
	240	50	3	—	205	179	20 900	18 300	13.1	2 900	3 400	1 900	6322	ZZ	—	LLU
120	150	16	1	0.5	28.9	33.0	2 950	3 350	16.0	4 000	4 700	—	6824	—	—	—
	165	22	1.1	0.5	53.0	54.0	5 400	5 500	16.5	3 800	4 400	—	6924	—	—	—
	180	19	1	—	63.0	63.5	6 450	6 450	16.4	3 500	4 100	—	16024	—	—	—
	180	28	2	0.5	85.0	79.5	8 650	8 100	15.9	3 500	4 100	2 100	6024	ZZ	LLB	LLU

1) Smallest allowable dimension for chamfer dimension r.

Deep Groove Ball Bearings

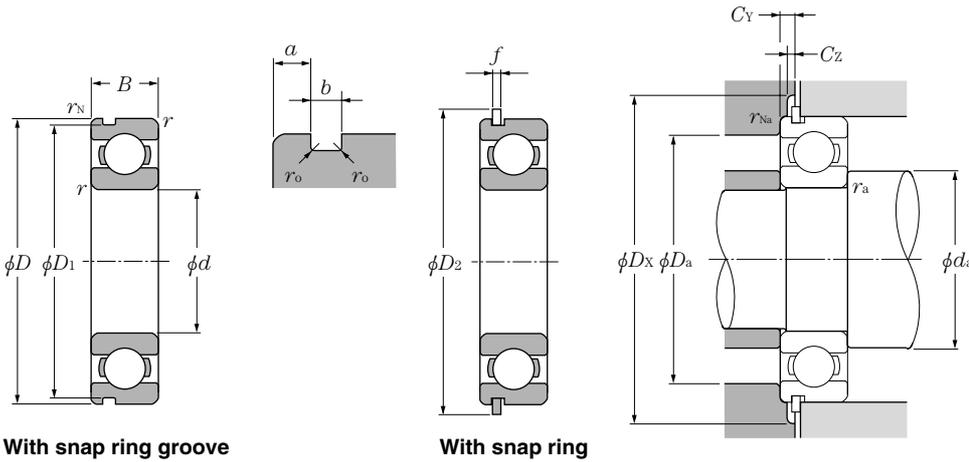

Dynamic equivalent radial load

$$P_r = X F_r + Y F_a$$

$\frac{f_0 \cdot F_a}{C_{or}}$	e	$\frac{F_a}{F_r} \leq e$		$\frac{F_a}{F_r} > e$	
		X	Y	X	Y
0.172	0.19				2.30
0.345	0.22				1.99
0.689	0.26				1.71
1.03	0.28				1.55
1.38	0.30	1	0	0.56	1.45
2.07	0.34				1.31
3.45	0.38				1.15
5.17	0.42				1.04
6.89	0.44				1.00

Static equivalent radial load

$$P_{or} = 0.6 F_r + 0.5 F_a$$

When $P_{or} < F_r$ use $P_{or} = F_r$

Bearing numbers	Snap ring groove dimensions mm				Snap ring dimensions mm		Abutment and fillet dimensions mm								Mass ⁴⁾ kg	
	snap ²⁾ ring groove	snap ²⁾ ring	D ₁ max	a max	b min	r ₀ max	D ₂ max	f max	d _a min	d _a max ³⁾	D _a max	D _X (approx.)	C _Y max	C _Z min		r _{as} max
N	NR	112.6	2.1	1.3	0.4	120.7	1.12	95	96	110	122	2.9	1.2	1	0.5	0.285
N	NR	122.6	3.3	1.3	0.4	130.7	1.12	96.5	99	118.5	132	4.1	1.2	1	0.5	0.554
—	—	—	—	—	—	—	—	95	—	135	—	—	—	1	—	0.848
N	NR	135.23	3.71	3.1	0.6	149.7	2.82	98	102	132	152	6.1	2.9	1.5	0.5	1.02
N	NR	155.22	4.9	3.1	0.6	169.7	2.82	99	109	151	172	7.3	2.9	2	0.5	2.15
N	NR	183.64	5.69	3.5	0.6	202.9	3.1	103	118	177	205	8.4	3.1	2.5	0.5	4.91
N	NR	117.6	2.1	1.3	0.4	125.7	1.12	100	101	115	127	2.9	1.2	1	0.5	0.3
N	NR	127.6	3.3	1.3	0.4	135.7	1.12	101.5	104	123.5	137	4.1	1.2	1	0.5	0.579
—	—	—	—	—	—	—	—	100	—	140	—	—	—	1	—	0.885
N	NR	140.23	3.71	3.1	0.6	154.7	2.82	103	109	137	157	6.1	2.9	1.5	0.5	1.08
N	NR	163.65	5.69	3.5	0.6	182.9	3.1	106	116	159	185	8.4	3.1	2	0.5	2.62
N	NR	193.65	5.69	3.5	0.6	212.9	3.1	108	125	187	215	8.4	3.1	2.5	0.5	5.67
N	NR	122.6	2.1	1.3	0.4	130.7	1.12	105	106	120	132	2.9	1.2	1	0.5	0.313
N	NR	137.6	3.3	1.9	0.6	145.7	1.7	106.5	110	133.5	147	4.7	1.7	1	0.5	0.785
—	—	—	—	—	—	—	—	105	—	145	—	—	—	1	—	0.91
N	NR	145.24	3.71	3.1	0.6	159.7	2.82	108	110	142	162	6.1	2.9	1.5	0.5	1.15
N	NR	173.66	5.69	3.5	0.6	192.9	3.1	111	122	169	195	8.4	3.1	2	0.5	3.14
N	NR	208.6	5.69	3.5	1	227.8	3.1	113	133	202	230	8.4	3.1	2.5	0.5	7
N	NR	127.6	2.1	1.3	0.4	135.7	1.12	110	—	125	137	2.9	1.2	1	0.5	0.33
N	NR	142.6	3.3	1.9	0.6	150.7	1.7	111.5	115	138.5	152	4.7	1.7	1	0.5	0.816
—	—	—	—	—	—	—	—	110	—	155	—	—	—	1	—	1.2
N	NR	155.22	3.71	3.1	0.6	169.7	2.82	114	119	151	172	6.1	2.9	2	0.5	1.59
N	NR	183.64	5.69	3.5	0.6	202.9	3.1	116	125	179	205	8.4	3.1	2	0.5	3.7
N	NR	217.0	6.5	4.5	1	237	3.5	118	134	212	239	9.6	3.5	2.5	0.5	8.05
N	NR	137.6	2.5	1.9	0.6	145.7	1.7	115	—	135	147	3.9	1.7	1	0.5	0.515
N	NR	147.6	3.3	1.9	0.6	155.7	1.7	116.5	120	143.5	157	4.7	1.7	1	0.5	0.849
—	—	—	—	—	—	—	—	115	—	165	—	—	—	1	—	1.46
N	NR	163.65	3.71	3.5	0.6	182.9	3.1	119	126	161	185	6.4	3.1	2	0.5	1.96
N	NR	193.65	5.69	3.5	0.6	212.9	3.1	121	132	189	215	8.4	3.1	2	0.5	4.36
N	NR	232.0	6.5	4.5	1	252	3.5	123	149	227	254	9.6	3.5	2.5	0.5	9.54
N	NR	147.6	2.5	1.9	0.6	155.7	1.7	125	—	145	157	3.9	1.7	1	0.5	0.555
N	NR	161.8	3.7	1.9	0.6	171.5	1.7	126.5	—	158.5	173	5.1	1.7	1	0.5	1.15
—	—	—	—	—	—	—	—	125	—	175	—	—	—	1	—	1.56
N	NR	173.66	3.71	3.5	0.6	192.9	3.1	129	136	171	195	6.4	3.1	2	0.5	2.07

2) Sealed and shielded bearings are also available. 3) This dimension applies to sealed and shielded bearings. 4) Does not include bearings with snap rings.

Deep Groove Ball Bearings

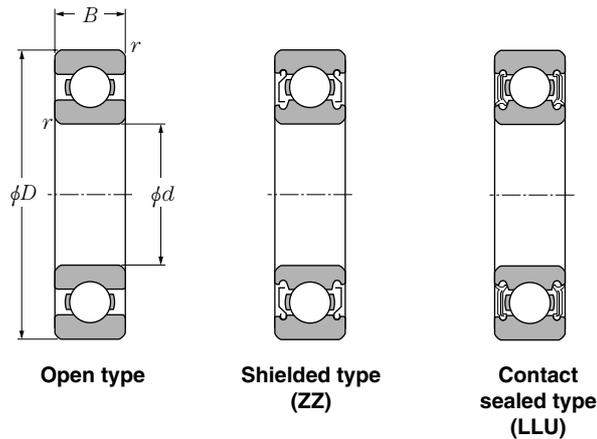

d 120 ~ 170mm

d	Boundary dimensions				Basic load ratings				Factor f_o	Limiting speeds			Bearing numbers		
	mm				kN		kgf			grease open type ZZ	oil open type Z	LLU	open type	shielded type	contact sealed type
	D	B	$r_{s \min}^{1)}$	$r_{NS \min}$	C_r	C_{or}	C_r	C_{or}							
120	215	40	2.1	—	155	131	15 900	13 400	14.4	2 900	3 400	2 000	6224	ZZ	LLU
	260	55	3	—	207	185	21 100	18 800	13.5	2 600	3 100	—	6324	—	—
130	165	18	1.1	0.5	37.0	41.0	3 750	4 200	16.1	3 700	4 300	—	6826	—	—
	180	24	1.5	0.5	65.0	67.5	6 650	6 850	16.5	3 500	4 100	—	6926	—	—
	200	22	1.1	—	80.0	79.5	8 150	8 100	16.2	3 200	3 800	—	16026	—	—
	200	33	2	0.5	106	101	10 800	10 300	15.8	3 200	3 800	1 900	6026	ZZ	LLU
	230	40	3	—	167	146	17 000	14 900	14.5	2 700	3 100	—	6226	—	—
	280	58	4	—	229	214	23 400	21 800	13.6	2 400	2 800	—	6326	—	—
140	175	18	1.1	0.5	38.5	44.5	3 900	4 550	16.0	3 400	4 000	—	6828	—	—
	190	24	1.5	0.5	66.5	71.5	6 800	7 300	16.6	3 200	3 800	—	6928	—	—
	210	22	1.1	—	82.0	85.0	8 350	8 650	16.4	3 000	3 500	—	16028	—	—
	210	33	2	—	110	109	11 200	11 100	15.9	3 000	3 500	1 800	6028	ZZ	LLU
	250	42	3	—	166	150	17 000	15 300	14.8	2 500	2 900	—	6228	—	—
	300	62	4	—	253	246	25 800	25 100	13.6	2 200	2 600	—	6328	—	—
150	190	20	1.1	0.5	47.5	55.0	4 850	5 600	16.1	3 100	3 700	—	6830	—	—
	210	28	2	—	85.0	90.5	8 650	9 200	16.5	3 000	3 500	—	6930	—	—
	225	24	1.1	—	96.5	101	9 850	10 300	16.4	2 800	3 200	—	16030	—	—
	225	35	2.1	—	126	126	12 800	12 800	15.9	2 800	3 200	1 700	6030	ZZ	LLU
	270	45	3	—	176	168	18 000	17 100	15.1	2 300	2 700	—	6230	—	—
	320	65	4	—	274	284	28 000	28 900	13.9	2 100	2 400	—	6330	—	—
160	200	20	1.1	0.5	48.5	57.0	4 950	5 800	16.1	2 900	3 400	—	6832	—	—
	220	28	2	—	87.0	96.0	8 850	9 800	16.6	2 800	3 300	—	6932	—	—
	240	25	1.5	—	99.0	108	10 100	11 000	16.5	2 600	3 000	—	16032	—	—
	240	38	2.1	—	143	144	14 500	14 700	15.9	2 600	3 000	1 600	6032	ZZ	LLU
	290	48	3	—	185	186	18 900	19 000	15.4	2 100	2 500	—	6232	—	—
	340	68	4	—	278	286	28 300	29 200	13.9	1 900	2 300	—	6332	—	—
170	215	22	1.1	—	60.0	70.5	6 100	7 200	16.1	2 700	3 200	—	6834	—	—
	230	28	2	—	86.0	95.5	8 750	9 750	16.5	2 600	3 100	—	6934	—	—
	260	28	1.5	—	119	128	12 100	13 100	16.4	2 400	2 800	—	16034	—	—
	260	42	2.1	—	168	172	17 200	17 600	15.8	2 400	2 800	—	6034	—	—
	310	52	4	—	212	223	21 700	22 800	15.3	2 000	2 400	—	6234	—	—
	360	72	4	—	325	355	33 500	36 000	13.6	1 800	2 100	—	6334	—	—

1) Smallest allowable dimension for chamfer dimension r .

Deep Groove Ball Bearings

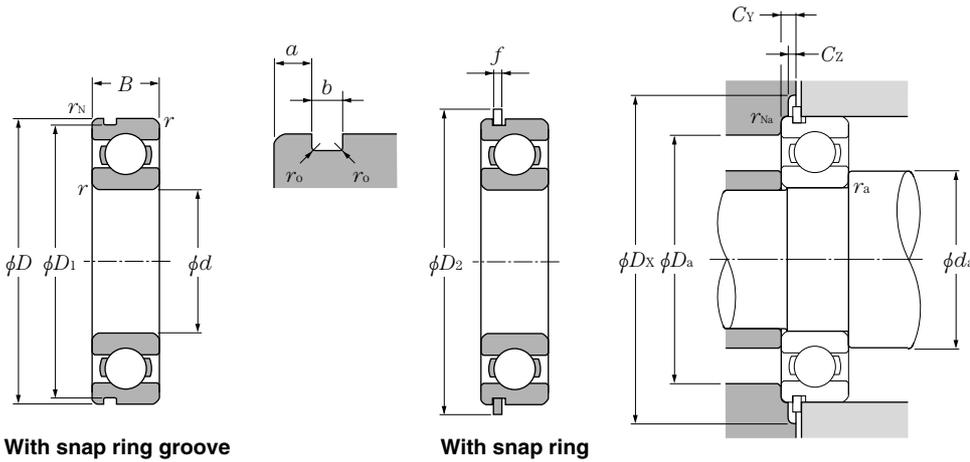

Dynamic equivalent radial load

$$P_r = X F_r + Y F_a$$

$\frac{f_0 \cdot F_a}{C_{or}}$	e	$\frac{F_a}{F_r} \leq e$		$\frac{F_a}{F_r} > e$	
		X	Y	X	Y
0.172	0.19				2.30
0.345	0.22				1.99
0.689	0.26				1.71
1.03	0.28				1.55
1.38	0.30	1	0	0.56	1.45
2.07	0.34				1.31
3.45	0.38				1.15
5.17	0.42				1.04
6.89	0.44				1.00

Static equivalent radial load

$$P_{or} = 0.6 F_r + 0.5 F_a$$

When $P_{or} < F_r$ use $P_{or} = F_r$

Bearing numbers		Snap ring groove dimensions mm				Snap ring dimensions mm		Abutment and fillet dimensions mm								Mass ⁴⁾
snap ²⁾ ring groove	snap ²⁾ ring	D_1 max	a max	b min	r_0 max	D_2 max	f max	d_a min	d_a max ³⁾	D_a max	D_x (approx.)	C_Y max	C_Z min	r_{as} max	r_{Ns} max	kg (approx.)
N	NR	217.0	6.5	4.5	1	227.8	3.1	131	143	204	230	9.2	3.1	2	0.5	5.15
—	—	—	—	—	—	—	—	133	—	247	—	—	—	2.5	—	12.4
N	NR	161.8	3.3	1.9	0.6	171.5	1.7	136.5	—	158.5	173	4.7	1.7	1	0.5	0.8
N	NR	176.8	3.7	1.9	0.6	186.5	1.7	138	—	172	188	5.1	1.7	1.5	0.5	1.52
—	—	—	—	—	—	—	—	136.5	—	193.5	—	—	—	1	—	2.31
N	NR	193.65	5.69	3.5	0.6	212.9	3.1	139	148	191	215	8.4	3.1	2	0.5	3.16
N	NR	222.0	6.5	4.5	1	242	3.5	143	—	217	244	9.6	3.5	2.5	0.5	5.82
—	—	—	—	—	—	—	—	146	—	264	—	—	—	3	—	15.3
N	NR	171.8	3.3	1.9	0.6	181.5	1.7	146.5	—	168.5	183	4.7	1.7	1	0.5	0.85
N	NR	186.8	3.7	1.9	0.6	196.5	1.7	148	—	182	198	5.1	1.7	1.5	0.5	1.62
—	—	—	—	—	—	—	—	146.5	—	203.5	—	—	—	1	—	2.45
—	—	—	—	—	—	—	—	149	158	201	—	—	—	2	—	3.35
N	NR	242.0	6.5	4.5	1	262	3.5	153	—	237	264	9.6	3.5	2.5	0.5	7.57
—	—	—	—	—	—	—	—	156	—	284	—	—	—	3	—	18.5
N	NR	186.8	3.3	1.9	0.6	196.5	1.7	156.5	—	183.5	198	4.7	1.7	1	0.5	1.16
—	—	—	—	—	—	—	—	159	—	201	—	—	—	2	—	2.47
—	—	—	—	—	—	—	—	156.5	—	218.5	—	—	—	1	—	3.07
—	—	—	—	—	—	—	—	161	169	214	—	—	—	2	—	4.08
—	—	—	—	—	—	—	—	163	—	257	—	—	—	2.5	—	9.41
—	—	—	—	—	—	—	—	166	—	304	—	—	—	3	—	22
N	NR	196.8	3.3	1.9	0.6	206.5	1.7	166.5	—	193.5	208	4.7	1.7	1	0.5	1.23
—	—	—	—	—	—	—	—	169	—	211	—	—	—	2	—	2.61
—	—	—	—	—	—	—	—	168	—	232	—	—	—	1.5	—	3.64
—	—	—	—	—	—	—	—	171	183	229	—	—	—	2	—	5.05
—	—	—	—	—	—	—	—	173	—	277	—	—	—	2.5	—	11.7
—	—	—	—	—	—	—	—	176	—	324	—	—	—	3	—	26
—	—	—	—	—	—	—	—	176.5	—	208.5	—	—	—	1	—	1.63
—	—	—	—	—	—	—	—	179	—	221	—	—	—	2	—	2.74
—	—	—	—	—	—	—	—	178	—	252	—	—	—	1.5	—	4.93
—	—	—	—	—	—	—	—	181	—	249	—	—	—	2	—	6.76
—	—	—	—	—	—	—	—	186	—	294	—	—	—	3	—	14.5
—	—	—	—	—	—	—	—	186	—	344	—	—	—	3	—	30.7

2) Sealed and shielded bearings are also available.

3) This dimension applies to sealed and shielded bearings.

4) Does not include bearings with snap rings.

Deep Groove Ball Bearings

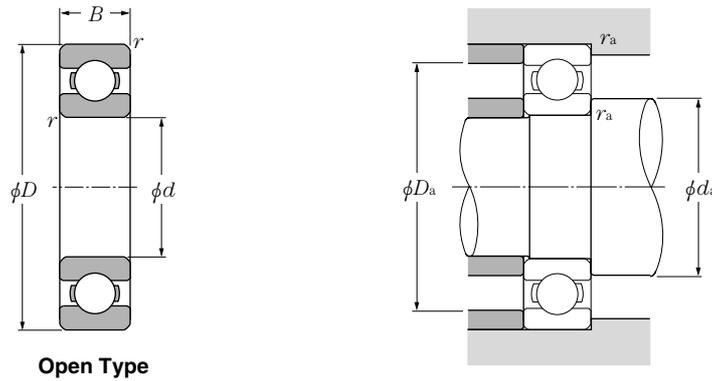

Open Type

d 180 ~ 260mm

d	Boundary dimensions			Basic load ratings				Factor f_o	Limiting speeds		Bearing numbers
	mm			dynamic	static	dynamic	static		min ⁻¹		
	D	B	$r_{s \min}^{1)}$	C_r	C_{or}	C_r	C_{or}		grease lubrication	oil lubrication	
180	225	22	1.1	60.5	73.0	6 200	7 450	16.1	2 600	3 000	6836
	250	33	2	110	119	11 200	12 200	16.5	2 400	2 900	6936
	280	31	2	117	134	11 900	13 600	16.5	2 300	2 700	16036
	280	46	2.1	189	199	19 300	20 300	15.6	2 300	2 700	6036
	320	52	4	227	241	23 200	24 600	15.1	1 900	2 200	6236
	380	75	4	355	405	36 000	41 500	13.9	1 700	2 000	6336
190	240	24	1.5	73.0	88.0	7 450	9 000	16.1	2 400	2 900	6838
	260	33	2	113	127	11 500	13 000	16.6	2 300	2 700	6938
	290	31	2	134	156	13 700	15 900	16.6	2 100	2 500	16038
	290	46	2.1	197	215	20 100	21 900	15.8	2 100	2 500	6038
	340	55	4	255	281	26 000	28 700	15.0	1 800	2 100	6238
	400	78	5	355	415	36 000	42 500	14.1	1 600	1 900	6338
200	250	24	1.5	74.0	91.5	7 550	9 300	16.1	2 300	2 700	6840
	280	38	2.1	157	168	16 000	17 100	16.2	2 200	2 600	6940
	310	34	2	142	160	14 400	16 300	16.6	2 000	2 400	16040
	310	51	2.1	218	243	22 200	24 800	15.6	2 000	2 400	6040
	360	58	4	269	310	27 400	31 500	15.2	1 700	2 000	6240
	420	80	5	410	500	42 000	51 000	13.8	1 500	1 800	6340
220	270	24	1.5	76.5	98.0	7 800	10 000	16.0	2 100	2 400	6844
	300	38	2.1	160	180	16 400	18 400	16.4	2 000	2 300	6944
	340	37	2.1	181	216	18 500	22 000	16.5	1 800	2 200	16044
	340	56	3	241	289	24 600	29 400	15.8	1 800	2 200	6044
	400	65	4	297	365	30 500	37 000	15.3	1 500	1 800	6244
	460	88	5	410	520	42 000	53 000	14.3	1 400	1 600	6344
240	300	28	2	85.0	112	8 650	11 400	15.9	1 900	2 200	6848
	320	38	2.1	170	203	17 300	20 700	16.5	1 800	2 100	6948
	360	37	2.1	178	217	18 200	22 100	16.5	1 700	2 000	16048
	360	56	3	249	310	25 400	32 000	16.0	1 700	2 000	6048
260	320	28	2	87.0	120	8 900	12 200	15.8	1 700	2 000	6852
	360	46	2.1	222	280	22 600	28 500	16.3	1 600	1 900	6952
	400	44	3	227	299	23 200	30 500	16.5	1 500	1 800	16052
	400	65	4	291	375	29 700	38 500	15.8	1 500	1 800	6052

1) Smallest allowable dimension for chamfer dimension r .



Dynamic equivalent radial load

$$P_r = X F_r + Y F_a$$

$\frac{f_0 \cdot F_a}{C_{or}}$	e	$\frac{F_a}{F_r} \leq e$		$\frac{F_a}{F_r} > e$	
		X	Y	X	Y
0.172	0.19				2.30
0.345	0.22				1.99
0.689	0.26				1.71
1.03	0.28				1.55
1.38	0.30	1	0	0.56	1.45
2.07	0.34				1.31
3.45	0.38				1.15
5.17	0.42				1.04
6.89	0.44				1.00

Static equivalent radial load

$$P_{or} = 0.6 F_r + 0.5 F_a$$

When $P_{or} < F_r$ use $P_{or} = F_r$

Abutment and fillet dimensions mm			Mass kg
d_a min	D_a max	r_{as} max	(approx.)

186.5	218.5	1	2.03
189	241	2	4.76
189	271	2	6.49
191	269	2	8.8
196	304	3	15.1
196	364	3	35.6
<hr/>			
198	232	1.5	2.62
199	251	2	4.98
199	281	2	6.77
201	279	2	9.18
206	324	3	18.2
210	380	4	41
<hr/>			
208	242	1.5	2.73
211	269	2	7.1
209	301	2	8.68
211	299	2	11.9
216	344	3	21.6
220	400	4	46.3
<hr/>			
228	262	1.5	3
231	289	2	7.69
231	329	2	11.3
233	327	2.5	15.7
236	384	3	30.2
240	440	4	60.8
<hr/>			
249	291	2	4.6
251	309	2	8.28
251	349	2	12.1
253	347	2.5	16.8
<hr/>			
269	311	2	5
271	349	2	13.9
273	387	2.5	18.5
276	384	3	25



Deep Groove Ball Bearings

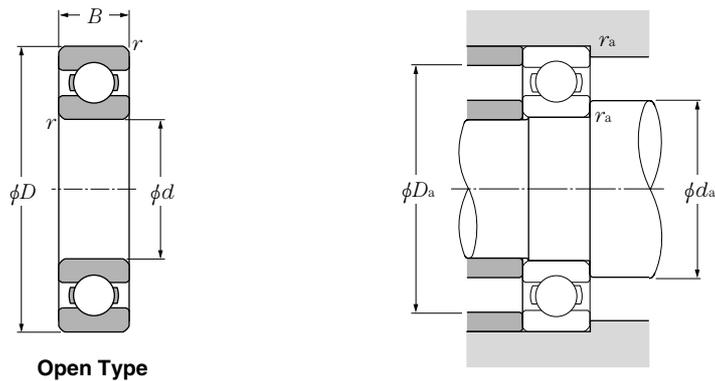

Open Type

d 280 ~ 440mm

d	Boundary dimensions			Basic load ratings				Factor f_0	Limiting speeds		Bearing numbers
	mm			dynamic	static	dynamic	static		min ⁻¹		
	D	B	$r_{s, min}^{1)}$	C_r	C_{or}	C_r	C_{or}		grease lubrication	oil lubrication	
280	350	33	2	137	177	13 900	18 100	16.1	1 600	1 900	6856
	380	46	2.1	227	299	23 200	30 500	16.5	1 500	1 800	6956
	420	44	3	232	315	23 700	32 500	16.5	1 400	1 600	16056
	420	65	4	325	420	33 000	43 000	15.5	1 400	1 600	6056
300	380	38	2.1	162	210	16 500	21 500	16.1	1 500	1 700	6860
	420	56	3	276	375	28 200	38 500	16.2	1 400	1 600	6960
	460	50	4	292	410	29 800	42 000	16.3	1 300	1 500	16060
	460	74	4	355	480	36 000	49 000	15.6	1 300	1 500	6060
320	400	38	2.1	168	228	17 200	23 200	16.1	1 400	1 600	6864
	440	56	3	285	405	29 000	41 000	16.4	1 300	1 500	6964
	480	50	4	300	440	30 500	45 000	16.4	1 200	1 400	16064
	480	74	4	370	530	38 000	54 000	15.7	1 200	1 400	6064
340	420	38	2.1	170	236	17 400	24 000	16.0	1 300	1 500	6868
	460	56	3	293	430	29 800	44 000	16.5	1 200	1 400	6968
	520	57	4	340	515	35 000	52 500	16.3	1 100	1 300	16068
	520	82	5	420	610	42 500	62 500	15.6	1 100	1 300	6068
360	440	38	2.1	187	258	19 100	26 300	16.0	1 200	1 400	6872
	480	56	3	300	455	30 500	46 500	16.5	1 100	1 300	6972
	540	57	4	350	550	36 000	56 000	16.4	1 100	1 200	16072
	540	82	5	440	670	44 500	68 000	15.7	1 100	1 200	6072
380	480	46	2.1	231	340	23 600	34 500	16.1	1 100	1 300	6876
	520	65	4	325	510	33 000	52 000	16.6	1 100	1 200	6976
	560	82	5	455	725	46 500	74 000	15.9	990	1 200	6076
400	500	46	2.1	226	340	23 100	34 500	16.0	1 100	1 200	6880
	540	65	4	335	535	34 000	54 500	16.5	990	1 200	6980
	600	90	5	510	825	52 000	84 000	15.7	930	1 100	6080
420	520	46	2.1	260	405	26 500	41 500	16.1	1 000	1 200	6884
	560	65	4	340	560	35 000	57 000	16.4	940	1 100	6984
	620	90	5	530	895	54 000	91 000	15.8	880	1 000	6084
440	540	46	2.1	264	420	26 900	43 000	16.0	950	1 100	6888
	600	74	4	365	615	37 500	63 000	16.4	890	1 000	6988

1) Smallest allowable dimension for chamfer dimension r.



Dynamic equivalent radial load

$$P_r = X F_r + Y F_a$$

$\frac{f_0 \cdot F_a}{C_{or}}$	e	$\frac{F_a}{F_r} \leq e$		$\frac{F_a}{F_r} > e$	
		X	Y	X	Y
		0.172	0.19		
0.345	0.22				1.99
0.689	0.26				1.71
1.03	0.28				1.55
1.38	0.30	1	0	0.56	1.45
2.07	0.34				1.31
3.45	0.38				1.15
5.17	0.42				1.04
6.89	0.44				1.00

Static equivalent radial load

$$P_{or} = 0.6 F_r + 0.5 F_a$$

When $P_{or} < F_r$ use $P_{or} = F_r$

Abutment and fillet dimensions mm			Mass kg
d_a min	D_a max	r_{as} max	(approx.)
289	341	2	7.4
291	369	2	14.8
293	407	2.5	23
296	404	3	31
<hr/>			
311	369	2	10.5
313	407	2.5	23.5
316	444	3	32.5
316	444	3	43.8
<hr/>			
331	389	2	10.9
333	427	2.5	24.8
336	464	3	34.2
336	464	3	46.1
<hr/>			
351	409	2	11.5
353	447	2.5	26.2
356	504	3	47.1
360	500	4	61.8
<hr/>			
371	429	2	12.3
373	467	2.5	27.5
376	524	3	49.3
380	520	4	64.7
<hr/>			
391	469	2	19.7
396	504	3	39.8
400	540	4	67.5
<hr/>			
411	489	2	20.6
416	524	3	41.6
420	580	4	87.6
<hr/>			
431	509	2	21.6
436	544	3	43.4
440	600	4	91.1
<hr/>			
451	529	2	22.5
456	584	3	60



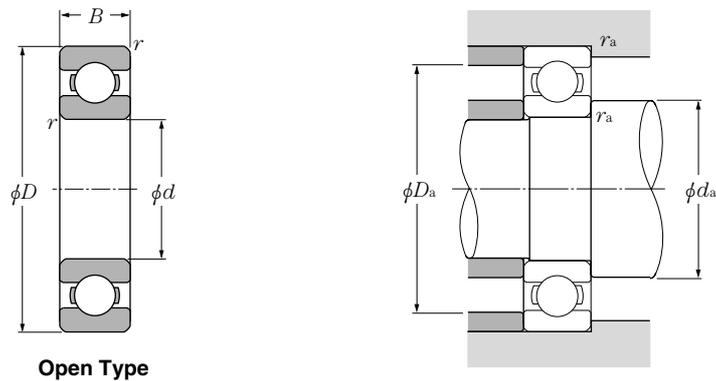

Open Type

d 460 ~ 600mm

d	Boundary dimensions			Basic load ratings				Factor f_o	Limiting speeds		Bearing numbers
	mm			dynamic	static	dynamic	static		min ⁻¹		
	D	B	$r_{s \min}^{1)}$	C _r	C _{or}	C _r	C _{or}		grease lubrication	oil lubrication	
460	580	56	3	315	515	32 000	52 500	16.2	900	1 100	6892
	620	74	4	375	645	38 500	66 000	16.4	850	1 000	6992
480	600	56	3	320	540	32 500	55 000	16.1	860	1 000	6896
	650	78	5	430	770	44 000	78 500	16.5	810	950	6996
500	620	56	3	325	560	33 500	57 000	16.1	820	970	68/500
	670	78	5	445	805	45 500	82 500	16.5	770	910	69/500
530	650	56	3	330	580	34 000	59 500	16.0	770	900	68/530
560	680	56	3	335	600	34 000	61 500	16.0	710	840	68/560
600	730	60	3	375	705	38 500	72 000	16.0	660	780	68/600

1) Smallest allowable dimension for chamfer dimension r.

Dynamic equivalent radial load

$$P_r = X F_r + Y F_a$$

$\frac{f_0 \cdot F_a}{C_{or}}$	e	$\frac{F_a}{F_r} \leq e$		$\frac{F_a}{F_r} > e$	
		X	Y	X	Y
0.172	0.19				2.30
0.345	0.22				1.99
0.689	0.26				1.71
1.03	0.28				1.55
1.38	0.30	1	0	0.56	1.45
2.07	0.34				1.31
3.45	0.38				1.15
5.17	0.42				1.04
6.89	0.44				1.00

Static equivalent radial load

$$P_{or} = 0.6 F_r + 0.5 F_a$$

When $P_{or} < F_r$ use $P_{or} = F_r$

Abutment and fillet dimensions mm			Mass kg
d_a min	D_a max	r_{as} max	(approx.)
473	567	2.5	34.8
476	604	3	62.2
493	587	2.5	36.2
500	630	4	73.0
513	607	2.5	37.5
520	650	4	75.5
543	637	2.5	39.5
573	667	2.5	41.5
613	717	2.5	51.7



Expansion Compensating Bearings

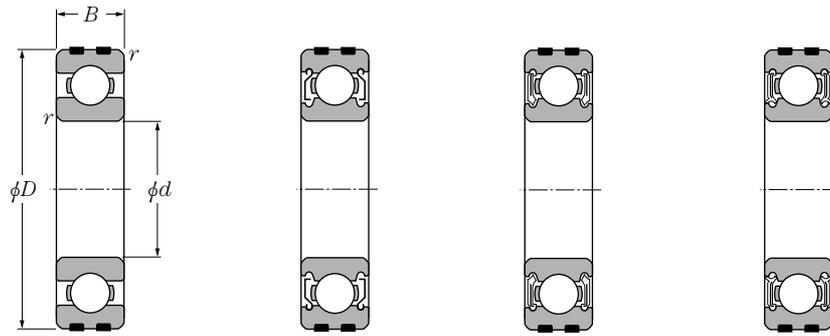

Open type

Shielded type (ZZ)

Non-contact sealed type (LLB)

Contact sealed type (LLU)

d 10 ~ 50mm

d	Boundary dimensions			Basic load ratings				Allowable load		Factor f_0	Limiting speeds			Bearing numbers				
	mm			dynamic		static		kN	kgf		min ⁻¹		LU, LLU		open type	shielded ¹⁾ type	non- ¹⁾ contact sealed type	contact sealed type
	D	B	$r_{s \min}^{(2)}$	C_r	C_{or}	C_r	C_{or}	C_p	C_p		grease open type ZZ, LLB	oil open type Z, LB						
10	26	8	0.3	4.55	1.96	465	200	1.65	168	12.4	29 000	34 000	21 000	EC-6000	ZZ	LLB	LLU	
	30	9	0.6	5.10	2.39	520	244	2.39	244	13.2	25 000	30 000	18 000	EC-6200	ZZ	LLB	LLU	
	35	11	0.6	8.20	3.50	835	355	3.45	355	11.4	23 000	27 000	16 000	EC-6300	ZZ	LLB	LLU	
12	28	8	0.3	5.10	2.39	520	244	1.78	181	13.2	26 000	30 000	18 000	EC-6001	ZZ	LLB	LLU	
	32	10	0.6	6.10	2.75	620	280	2.29	233	12.7	22 000	26 000	16 000	EC-6201	ZZ	LLB	LLU	
	37	12	1	9.70	4.20	990	425	3.65	375	11.1	20 000	24 000	15 000	EC-6301	ZZ	LLB	LLU	
15	32	9	0.3	5.60	2.83	570	289	2.83	289	13.9	22 000	26 000	15 000	EC-6002	ZZ	LLB	LLU	
	35	11	0.6	7.75	3.60	790	365	2.78	284	12.7	19 000	23 000	15 000	EC-6202	ZZ	LLB	LLU	
	42	13	1	11.4	5.45	1 170	555	4.40	450	12.3	17 000	21 000	12 000	EC-6302	ZZ	LLB	LLU	
17	35	10	0.3	6.80	3.35	695	345	2.88	294	13.6	20 000	24 000	14 000	EC-6003	ZZ	LLB	LLU	
	40	12	0.6	9.60	4.60	980	465	3.45	350	12.8	18 000	21 000	12 000	EC-6203	ZZ	LLB	LLU	
	47	14	1	13.5	6.55	1 380	665	6.55	665	12.2	16 000	19 000	11 000	EC-6303	ZZ	LLB	LLU	
20	42	12	0.6	9.40	5.05	955	515	5.05	515	13.9	18 000	21 000	11 000	EC-6004	ZZ	LLB	LLU	
	47	14	1	12.8	6.65	1 310	680	5.05	515	13.2	16 000	18 000	10 000	EC-6204	ZZ	LLB	LLU	
	52	15	1.1	15.9	7.90	1 620	805	7.90	805	12.4	14 000	17 000	10 000	EC-6304	ZZ	LLB	LLU	
25	47	12	0.6	10.1	5.85	1 030	595	5.85	595	14.5	15 000	18 000	9 400	EC-6005	ZZ	LLB	LLU	
	52	15	1	14.0	7.85	1 430	800	6.55	665	13.9	13 000	15 000	8 900	EC-6205	ZZ	LLB	LLU	
	62	17	1.1	21.2	10.9	2 160	1 110	10.9	1 110	12.6	12 000	14 000	8 100	EC-6305	ZZ	LLB	LLU	
30	55	13	1	13.2	8.30	1 350	845	8.30	845	14.8	13 000	15 000	7 700	EC-6006	ZZ	LLB	LLU	
	62	16	1	19.5	11.3	1 980	1 150	9.85	1 000	13.8	11 000	13 000	7 300	EC-6206	ZZ	LLB	LLU	
	72	19	1.1	26.7	15.0	2 720	1 530	15.0	1 530	13.3	10 000	12 000	6 600	EC-6306	ZZ	LLB	LLU	
35	62	14	1	16.0	10.3	1 630	1 050	10.3	1 050	14.8	12 000	14 000	6 800	EC-6007	ZZ	LLB	LLU	
	72	17	1.1	25.7	15.3	2 620	1 560	14.5	1 480	13.8	9 800	11 000	6 300	EC-6207	ZZ	LLB	LLU	
	80	21	1.5	33.5	19.1	3 400	1 950	18.5	1 890	13.1	8 800	10 000	6 000	EC-6307	ZZ	LLB	LLU	
40	68	15	1	16.8	11.5	1 710	1 170	11.5	1 170	15.2	10 000	12 000	6 100	EC-6008	ZZ	LLB	LLU	
	80	18	1.1	29.1	17.8	2 970	1 820	17.5	1 780	14.0	8 700	10 000	5 600	EC-6208	ZZ	LLB	LLU	
	90	23	1.5	40.5	24.0	4 150	2 450	23.4	2 380	13.2	7 800	9 200	5 300	EC-6308	ZZ	LLB	LLU	
45	75	16	1	21.0	15.1	2 140	1 540	15.1	1 540	15.3	9 200	11 000	5 400	EC-6009	ZZ	LLB	LLU	
	85	19	1.1	32.5	20.4	3 350	2 080	20.3	2 070	14.1	7 800	9 200	5 200	EC-6209	ZZ	LLB	LLU	
	100	25	1.5	53.0	32.0	5 400	3 250	27.4	2 790	13.1	7 000	8 200	4 700	EC-6309	ZZ	LLB	LLU	
50	80	16	1	21.8	16.6	2 230	1 690	16.6	1 690	15.5	8 400	9 800	5 000	EC-6010	ZZ	LLB	LLU	
	90	20	1.1	35.0	23.2	3 600	2 370	17.7	1 810	14.4	7 100	8 300	4 700	EC-6210	ZZ	LLB	LLU	
	110	27	2	62.0	38.5	6 300	3 900	33.0	3 350	13.2	6 400	7 500	4 200	EC-6310	ZZ	LLB	LLU	

1) This bearing number is for double sealed and double shielded type bearings, but single sealed and single shielded type are also available. 2) Smallest allowable dimension for chamfer dimension r.

Expansion Compensating Bearings

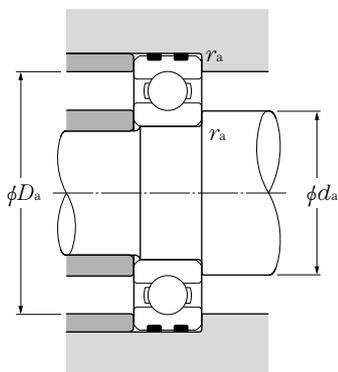

Dynamic equivalent radial load

$$P_r = XF_r + YF_a$$

$\frac{f_o \cdot F_a}{C_{or}}$	e	$\frac{F_a}{F_r} \leq e$		$\frac{F_a}{F_r} > e$	
		X	Y	X	Y
		0.172	0.19		
0.345	0.22				1.99
0.689	0.26				1.71
1.03	0.28				1.55
1.38	0.30	1	0	0.56	1.45
2.07	0.34				1.31
3.45	0.38				1.15
5.17	0.42				1.04
6.89	0.44				1.00

Static equivalent radial load

$$P_{or} = 0.6F_r + 0.5F_a$$

When $P_{or} < F_r$ use $P_{or} = F_r$

Abutment and fillet dimensions mm				Mass kg
d_a min	d_a max ³⁾	D_a max	r_{as} max	open type (approx.)
12	13.5	24	0.3	0.019
14	16	26	0.6	0.031
14	17	31	0.6	0.051
<hr/>				
14	16	26	0.3	0.021
16	17.5	28	0.6	0.036
17	18.5	32	1	0.058
<hr/>				
17	19	30	0.3	0.029
19	20.5	31	0.6	0.043
20	23	37	1	0.079
<hr/>				
19	21	33	0.3	0.037
21	23	36	0.6	0.062
22	25	42	1	0.11
<hr/>				
24	26	38	0.6	0.066
25	28	42	1	0.101
26.5	28.5	45.5	1	0.139
<hr/>				
29	30.5	43	0.6	0.075
30	32	47	1	0.122
31.5	35	55.5	1	0.223
<hr/>				
35	37	50	1	0.11
35	39	57	1	0.191
36.5	43	65.5	1	0.334
<hr/>				
40	42	57	1	0.148
41.5	45	65.5	1	0.277
43	47	72	1.5	0.44
<hr/>				
45	47	63	1	0.183
46.5	51	73.5	1	0.352
48	54	82	1.5	0.609
<hr/>				
50	52.5	70	1	0.233
51.5	55.5	78.5	1	0.391
53	61.5	92	1.5	0.80
<hr/>				
55	57.5	75	1	0.246
56.5	60	83.5	1	0.444
59	68.5	101	2	1.03

3) This dimension applies to sealed and shielded bearings.



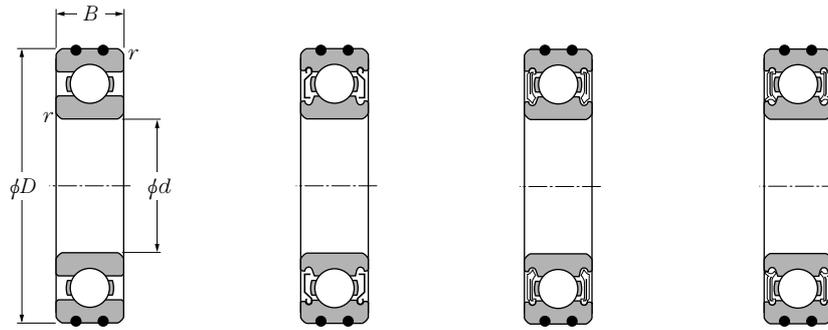

Open type

Shielded type (ZZ)

Non-contact sealed type (LLB)

Contact sealed type (LLU)

d 10 ~ 45mm

d	Boundary dimensions			Basic load ratings				Allowable load		Factor f_0	Limiting speeds			Bearing numbers				
	mm			dynamic		static		kN	kgf		min ⁻¹		LU, LLU		open type	shielded ¹⁾ type	non- ¹⁾ sealed type	contact sealed type
	D	B	$r_{s \min}^{(2)}$	C_r	C_{or}	C_r	C_{or}	C_p	C_p		grease open type ZZ, LLB	oil open type Z, LB	LU, LLU					
10	26	8	0.3	4.55	1.96	465	200	1.53	156	12.4	29 000	34 000	21 000	AC-6000	ZZ	LLB	LLU	
	30	9	0.6	5.10	2.39	520	244	2.39	244	13.2	25 000	30 000	18 000	AC-6200	ZZ	LLB	LLU	
	35	11	0.6	8.20	3.50	835	355	2.98	305	11.4	23 000	27 000	16 000	AC-6300	ZZ	LLB	LLU	
12	28	8	0.3	5.10	2.39	520	244	1.73	177	13.2	26 000	30 000	18 000	AC-6001	ZZ	LLB	LLU	
	32	10	0.6	6.10	2.75	620	280	2.75	280	12.7	22 000	26 000	16 000	AC-6201	ZZ	LLB	LLU	
	37	12	1	9.70	4.20	990	425	3.00	310	11.1	20 000	24 000	15 000	AC-6301	ZZ	LLB	LLU	
15	32	9	0.3	5.60	2.83	570	289	2.43	247	13.9	22 000	26 000	15 000	AC-6002	ZZ	LLB	LLU	
	35	11	0.6	7.75	3.60	790	365	2.71	277	12.7	19 000	23 000	15 000	AC-6202	ZZ	LLB	LLU	
	42	13	1	11.4	5.45	1 170	555	3.90	400	12.3	17 000	21 000	12 000	AC-6302	ZZ	LLB	LLU	
17	35	10	0.3	6.80	3.35	695	345	2.44	249	13.6	20 000	24 000	14 000	AC-6003	ZZ	LLB	LLU	
	40	12	0.6	9.60	4.60	980	465	3.50	355	12.8	18 000	21 000	12 000	AC-6203	ZZ	LLB	LLU	
	47	14	1	13.5	6.55	1 380	665	5.10	520	12.2	16 000	19 000	11 000	AC-6303	ZZ	LLB	LLU	
20	42	12	0.6	9.40	5.05	955	515	3.80	385	13.9	18 000	21 000	11 000	AC-6004	ZZ	LLB	LLU	
	47	14	1	12.8	6.65	1 310	680	4.20	430	13.2	16 000	18 000	10 000	AC-6204	ZZ	LLB	LLU	
	52	15	1.1	15.9	7.90	1 620	805	5.40	550	12.4	14 000	17 000	10 000	AC-6304	ZZ	LLB	LLU	
25	47	12	0.6	10.1	5.85	1 030	595	4.50	460	14.5	15 000	18 000	9 400	AC-6005	ZZ	LLB	LLU	
	52	15	1	14.0	7.85	1 430	800	5.80	590	13.9	13 000	15 000	8 900	AC-6205	ZZ	LLB	LLU	
	62	17	1.1	21.2	10.9	2 160	1 110	7.30	745	12.6	12 000	14 000	8 100	AC-6305	ZZ	LLB	LLU	
30	55	13	1	13.2	8.30	1 350	845	6.85	695	14.8	13 000	15 000	7 700	AC-6006	ZZ	LLB	LLU	
	62	16	1	19.5	11.3	1 980	1 150	7.55	770	13.8	11 000	13 000	7 300	AC-6206	ZZ	LLB	LLU	
	72	19	1.1	26.7	15.0	2 720	1 530	11.0	1 120	13.3	10 000	12 000	6 600	AC-6306	ZZ	LLB	LLU	
35	62	14	1	16.0	10.3	1 630	1 050	8.95	910	14.8	12 000	14 000	6 800	AC-6007	ZZ	LLB	LLU	
	72	17	1.1	25.7	15.3	2 620	1 560	9.65	985	13.8	9 800	11 000	6 300	AC-6207	ZZ	LLB	LLU	
	80	21	1.5	33.5	19.1	3 400	1 950	13.4	1 360	13.1	8 800	10 000	6 000	AC-6307	ZZ	LLB	LLU	
40	80	18	1.1	29.1	17.8	2 970	1 820	11.6	1 190	14.0	8 700	10 000	5 600	AC-6208	ZZ	LLB	LLU	
	90	23	1.5	40.5	24.0	4 150	2 450	16.6	1 690	13.2	7 800	9 200	5 300	AC-6308	ZZ	LLB	LLU	
45	85	19	1.1	32.5	20.4	3 350	2 080	14.7	1 500	14.1	7 800	9 200	5 200	AC-6209	ZZ	LLB	LLU	
	100	25	1.5	53.0	32.0	5 400	3 250	21.8	2 200	13.1	7 000	8 200	4 700	AC-6309	ZZ	LLB	LLU	

1) This bearing number is for double sealed and double shielded type bearings, but single sealed and single shielded type are also available. 2) Smallest allowable dimension for chamfer dimension r.

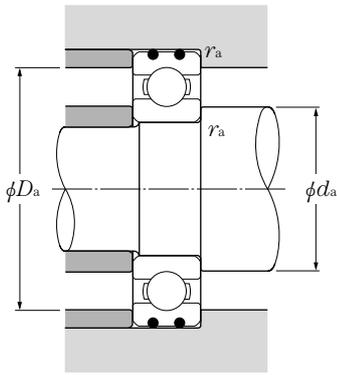

Dynamic equivalent radial load

$$P_r = X F_r + Y F_a$$

$\frac{f_0 \cdot F_a}{C_{or}}$	e	$\frac{F_a}{F_r} \leq e$		$\frac{F_a}{F_r} > e$	
		X	Y	X	Y
		0.172	0.19		
0.345	0.22				1.99
0.689	0.26				1.71
1.03	0.28				1.55
1.38	0.30	1	0	0.56	1.45
2.07	0.34				1.31
3.45	0.38				1.15
5.17	0.42				1.04
6.89	0.44				1.00

Static equivalent radial load

$$P_{or} = 0.6 F_r + 0.5 F_a$$

When $P_{or} < F_r$ use $P_{or} = F_r$

Abutment and fillet dimensions mm				Mass kg
d_a min	d_a max ³⁾	D_a max	r_{as} max	open type (approx.)
12	13.5	24	0.3	0.019
14	16	26	0.6	0.031
14	17	31	0.6	0.051
<hr/>				
14	16	26	0.3	0.021
16	17.5	28	0.6	0.036
17	18.5	32	1	0.058
<hr/>				
17	19	30	0.3	0.029
19	20.5	31	0.6	0.043
20	23	37	1	0.079
<hr/>				
19	21	33	0.3	0.037
21	23	36	0.6	0.062
22	25	42	1	0.11
<hr/>				
24	26	38	0.6	0.066
25	28	42	1	0.101
26.5	28.5	45.5	1	0.139
<hr/>				
29	30.5	43	0.6	0.075
30	32	47	1	0.122
31.5	35	55.5	1	0.223
<hr/>				
35	37	50	1	0.11
35	39	57	1	0.191
36.5	43	65.5	1	0.334
<hr/>				
40	42	57	1	0.148
41.5	45	65.5	1	0.277
43	47	72	1.5	0.44
<hr/>				
46.5	51	73.5	1	0.352
48	54	82	1.5	0.609
<hr/>				
51.5	55.5	78.5	1	0.391
53	61.5	92	1.5	0.80

3) This dimension applies to sealed and shielded bearings.





سجاد
چرخه کشور

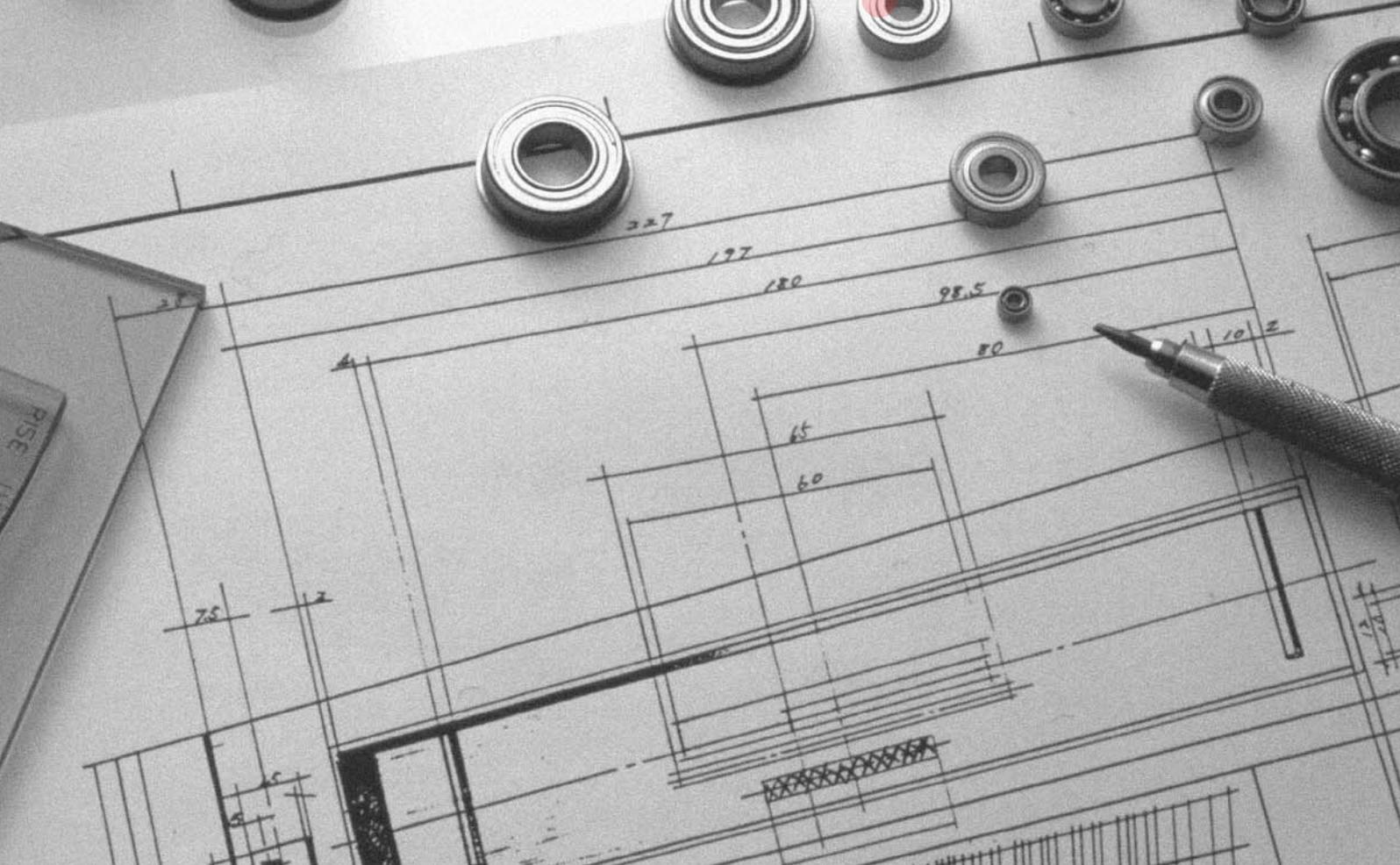



1. Design features and special characteristics

The dimensional range of miniature and extra small ball bearings is given in **Table 1**. Boundary dimensions for both metric and inch systems are in accordance with the internationally specified ISO and ANSI/ABMA standards. The most widely used sealed and shielded type ball bearings have a 1–2 mm wider width dimension than open type bearings.

The main variations of these bearings are shown in **Table 2**. Bearings with snap rings, which simplify the bearing housing construction and design, have also been serialized and are listed in dimension tables. Among the most generally used sealed and shielded bearings are standard ZZ and ZZA type which incorporate non-contact steel shield plates.

Diagram 1 also shows non-contact type rubber sealed LLB and resin sealed SSA type bearings, and the contact-type rubber sealed LLU bearing.

Table 1 Dimensional range

Bearing	Dimensional range
Miniature ball bearings	Nominal outer diameter $D < 9\text{mm}$
Extra small ball bearings	Nominal bore diameter $d < 10\text{mm}$ Nominal outer diameter $D \geq 9\text{mm}$

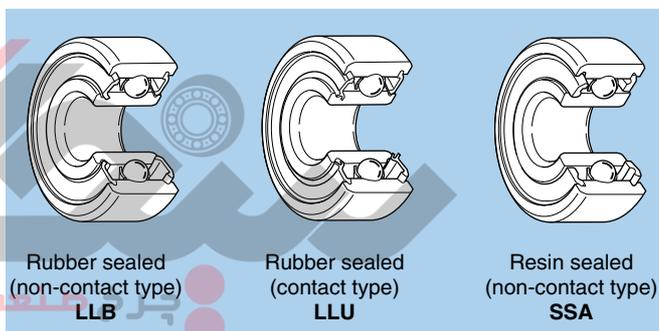

Diagram 1.

Table 2 Main types and construction

Type	Standard type code			Flange-attached type code		
	Construction	Metric series	Inch series	Construction	Metric series	Inch series
Open type		6 BC	R		FL6 FLBC	FLR
Shielded type		6 x x ZZ W6 x x ZZ WBC x x x ZZ	RA x x ZZ		FL6 x x x ZZ FLW6 x x x ZZ FLWBC x x ZZ	FLRA x x ZZ

Note: 1. Representative type codes are shown. For further details, please refer to dimension tables.
2. May change to ZA or SA for shielded type bearings, according to the bearing number.

2. Standard cage types

Pressed cage are standard for these bearings. However, molded resin cage are used for some bearings depending on the application.

3. Dimensional and rotational accuracy

The accuracy of miniature and extra small ball bearings complies with JIS standards. Accuracy standards are listed in the Bearings Tolerances clause on page A-35. Flange accuracies are listed in **Table 3**.

Table 3 Tolerance and tolerance values for outer ring flange

Units μm

Accuracy class		Outer diameter dimensional tolerance		Outer ring surface runout for rear surface S_{D1} Max.	Back face axial runout S_{ea1} Max.	Width dimension tolerance		Width unevenness V_{C1S} or V_{C2S} Max.
		ΔD_{1S} or ΔD_{2S} Upper	Lower			ΔC_{1S} or ΔC_{2S} Upper	Lower	
ISO standard	Class 0	* (see table below)		—	—	Identical to same bearing's inner ring V_{BS}		Identical to same bearing's inner ring V_{BS}
	Class 6			—	—			5
	Class 5			8	11			2.5
	Class 4			4	7			1.5
	Class 2			1.5	3 ^① 4			1.5

① Nominal outer diameter, 18 mm or less.

* Units μm

Flange nominal outer diameter D_1 or D_2 mm		Outer diameter dimensional tolerance ΔD_{1S} or ΔD_{2S}	
over	incl.	Upper	Lower
—	10	+220	-36
10	18	+270	-43
18	30	+330	-52
30	50	+390	-62

4. Radial internal clearance

Radial internal clearance values should be applied as listed in the table regarding the Bearing Internal Clearance and Preload clause on page A-58.

However, for miniature and extra small bearings, the radial clearance values for high precision bearings given in **Table 4**

are applied in many cases.

For more specific selection information, please refer to the **NTN Miniature and Extra Small Ball Bearings Catalog**, or contact **NTN Engineering**.

Table 4 Radial internal clearance for high precision bearings

Units μm

MIL Standard	Tight				Standard						Loose		Extra Loose	
Code	C2S		CNS		CNM		CNL		C3S		C3M		C3L	
Internal clearance	Min.	Max.	Min.	Max.	Min.	Max.	Min.	Max.	Min.	Max.	Min.	Max.	Min.	Max.
	0	5	3	8	5	10	8	13	10	15	13	20	20	28

Note: 1. These standards are specified in accordance with MIL B-23063. However, NTN codes are shown.

2. Clearance values do not include compensation for measuring load.



Miniature and Extra Small Ball Bearings

Metric series

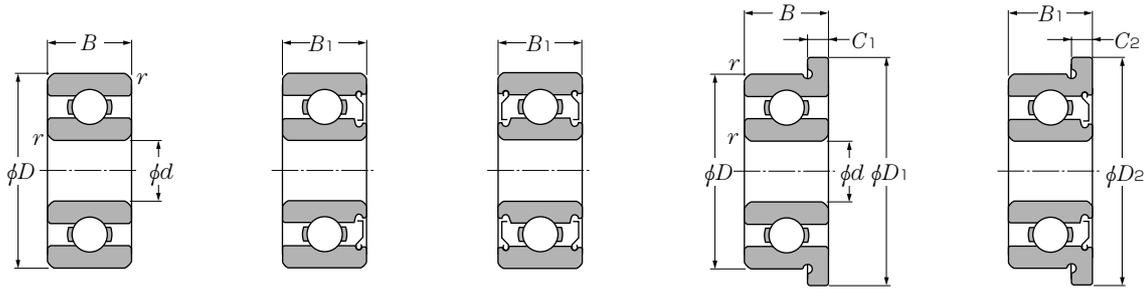

Open type

With single shield (Z)

With double shield (ZZ)

Open type with flange (FL)

With flanged outer ring and single shield (FL...Z)

d 1.5 ~ 5mm

d	Boundary dimensions								Basic load ratings				Factor f_0	Limiting speeds	
	D	B	B ₁	D ₁	D ₂	C ₁	C ₂	$r_{s\ min}^{1)}$	dynamic	static	dynamic	static		grease	oil
									N	C _{or}	C _r	C _{or}			
					mm						kgf				
1.5	4	1.2	2	5	5	0.4	0.6	0.15	102	29.0	10.0	3.00	13.6	88 000	100 000
	5	2	2.6	6.5	6.5	0.6	0.8	0.15	171	51.0	17.0	5.00	13.3	79 000	93 000
	6	2.5	3	7.5	7.5	0.6	0.8	0.15	274	86.0	28.0	9.00	12.3	71 000	84 000
2	4	1.2	—	—	—	—	—	0.05	104	37.0	11.0	4.00	14.8	83 000	98 000
	5	1.5	2.3	6.1	6.1	0.5	0.6	0.08	171	51.0	17.0	5.00	13.3	74 000	87 000
	5	2	2.5	—	—	—	—	0.1	171	51.0	17.0	5.00	13.3	74 000	87 000
	6	2.3	3	7.5	7.5	0.6	0.8	0.15	279	89.0	28.0	9.00	12.8	67 000	79 000
	6	2.5	—	7.2	—	0.6	—	0.15	279	89.0	28.0	9.00	12.8	67 000	79 000
	7	2.5	—	—	—	—	—	0.15	390	120	40.0	12.0	11.9	59 000	70 000
	7	2.8	3.5	8.5	8.5	0.7	0.9	0.15	380	125	39.0	13.0	12.4	62 000	73 000
2.5	5	1.5	2.3	—	—	—	—	0.08	153	59.0	16.0	6.00	15.0	70 000	82 000
	6	1.8	2.6	7.1	7.1	0.5	0.8	0.08	209	73.0	21.0	7.50	14.2	65 000	76 000
	7	—	3	—	8.2	—	0.6	0.15	284	96.0	29.0	10.0	13.8	59 000	70 000
	7	2.5	3.5	8.5	8.5	0.7	0.9	0.15	284	96.0	29.0	10.0	13.8	59 000	70 000
	8	2.5	2.8	9.2	—	0.6	—	0.15	430	152	44.0	16.0	13.2	56 000	66 000
	8	2.8	4	9.5	9.5	0.7	0.9	0.15	550	174	56.0	18.0	11.5	56 000	66 000
3	6	2	2.5	7.2	7.2	0.6	0.6	0.08	242	94.0	25.0	9.50	14.7	60 000	71 000
	7	2	3	8.1	8.1	0.5	0.8	0.1	390	130	40.0	13.0	13.0	58 000	68 000
	8	2.5	—	9.2	—	0.6	—	0.15	560	180	57.0	18.0	11.9	54 000	63 000
	8	3	4	9.5	9.5	0.7	0.9	0.15	560	180	57.0	18.0	11.9	54 000	63 000
	9	2.5	4	10.2	10.6	0.6	0.8	0.15	635	219	65.0	22.0	12.4	50 000	59 000
	9	3	5	10.5	10.5	0.7	1	0.15	635	219	65.0	22.0	12.4	50 000	59 000
	10	4	4	11.5	11.5	1	1	0.15	640	224	65.0	23.0	12.7	50 000	58 000
4	7	2	2.5	8.2	8.2	0.6	0.6	0.08	222	88.0	23.0	9.00	15.3	54 000	63 000
	8	2	3	9.2	9.2	0.6	0.6	0.08	395	140	40.0	14.0	13.9	52 000	61 000
	9	2.5	4	10.3	10.3	0.6	1	0.15	640	224	65.0	23.0	12.7	49 000	57 000
	10	3	4	11.2	11.6	0.6	0.8	0.15	650	235	66.0	24.0	13.3	46 000	55 000
	11	4	4	12.5	12.5	1	1	0.15	715	276	73.0	28.0	13.7	45 000	52 000
	12	4	4	13.5	13.5	1	1	0.2	970	360	99.0	36.0	12.8	43 000	51 000
	13	5	5	15	15	1	1	0.2	1 310	490	134	50.0	12.4	42 000	49 000
	16	5	5	—	—	—	—	0.3	1 760	680	179	69.0	12.4	37 000	44 000
5	8	2	2.5	9.2	9.2	0.6	0.6	0.08	217	91.0	22.0	9.50	15.8	49 000	57 000
	9	2.5	3	10.2	10.2	0.6	0.6	0.15	500	211	51.0	21.0	14.6	46 000	55 000
	10	3	4	11.2	11.6	0.6	0.8	0.15	715	276	73.0	28.0	13.7	45 000	52 000

1) Smallest allowable dimension for chamfer dimension r.

Miniature and Extra Small Ball Bearings

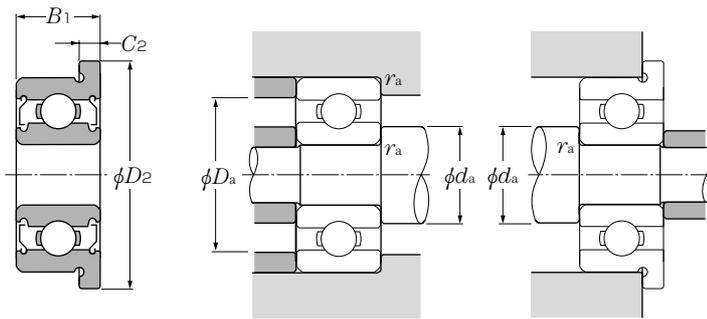

With flanged outer ring and double shield (FL...ZZ)

Dynamic equivalent radial load
 $P_r = X F_r + Y F_a$

$\frac{f_0 \cdot F_a}{C_{or}}$	e	$\frac{F_a}{F_r} \leq e$		$\frac{F_a}{F_r} > e$	
		X	Y	X	Y
0.172	0.19				2.30
0.345	0.22				1.99
0.689	0.26				1.71
1.03	0.28				1.55
1.38	0.30	1	0	0.56	1.45
2.07	0.34				1.31
3.45	0.38				1.15
5.17	0.42				1.04
6.89	0.44				1.00

Static equivalent radial load

$$P_{or} = 0.6 F_r + 0.5 F_a$$

When $P_{or} < F_r$ use $P_{or} = F_r$

Bearing numbers						Abutment and fillet dimensions				Mass (approx.)	
open	with single shield	with double shield	unsealed type with flange	with flanged OR and single shield	with flanged OR and double shield	mm			g		
						d_a	D_a	r_{as}	unsealed type		
						min	max ²⁾	max	max	open	with flange
68/1.5	W68/1.5SA	SSA	FL68/1.5	FLW68/1.5SA	SSA	2.3	2.4	3.2	0.05	0.07	0.09
69/1.5A	W69/1.5ASA	SSA	FL69/1.5A	FLW69/1.5ASA	SSA	2.7	2.9	3.8	0.15	0.18	0.24
60/1.5	W60/1.5ZA	ZZA	FL60/1.5	FLW60/1.5ZA	ZZA	2.7	3.0	4.8	0.15	0.35	0.42
672	—	—	—	—	—	2.5	2.6	3.5	0.05	0.06	—
682	W682SA	SSA	FL682	FLW682SA	SSA	2.8	2.9	4.2	0.08	0.13	0.17
BC2-5	WBC2-5SA	SSA	—	—	—	2.8	2.9	4.2	0.10	0.16	—
692	W692SA	SSA	FL692	FLW692SA	SSA	3.2	3.3	4.8	0.15	0.31	0.38
BC2-6	—	—	FLBC2-6	—	—	3.2	3.3	4.8	0.15	0.32	0.38
BC2-7A	—	—	—	—	—	3.2	3.6	5.8	0.15	0.44	—
602	W602ZA	ZZA	FL602	FLW602ZA	ZZA	3.2	3.7	5.8	0.15	0.54	0.64
67/2.5	W67/2.5ZA	ZZA	—	—	—	3.1	3.3	4.4	0.08	0.11	—
68/2.5	W68/2.5ZA	ZZA	FL68/2.5	FLW68/2.5ZA	ZZA	3.1	3.6	4.8	0.08	0.22	0.26
—	WBC2.5-7ZA	ZZA	—	FLWBC2.5-7ZA	ZZA	3.7	4.0	5.8	0.15	0.6 ³⁾	0.67 ³⁾
69/2.5	W69/2.5SA	SSA	FL69/2.5	FLW69/2.5SA	SSA	3.7	4.0	5.8	0.15	0.43	0.53
BC2.5-8	WBC2.5-8ZA	ZZA	FLBC2.5-8	—	—	3.7	4.3	6.8	0.15	0.57	0.65
60/2.5	W60/2.5ZA	ZZA	FL60/2.5	FLW60/2.5ZA	ZZA	3.7	4.1	6.8	0.15	0.72	0.83
673	WA673SA	SSA	FL673	FLWA673SA	SSA	3.6	4.1	5.4	0.08	0.2	0.26
683	W683ZA	ZZA	FL683	FLW683ZA	ZZA	3.9	4.1	5.8	0.1	0.33	0.38
BC3-8	—	—	FLBC3-8	—	—	4.2	4.4	6.8	0.15	0.52	0.6
693	W693Z	ZZ	FL693	FLW693Z	ZZ	4.2	4.4	6.8	0.15	0.61	0.72
BC3-9	WBC3-9ZA	ZZA	FLBC3-9	FLAWBC3-9ZA	ZZA	4.2	5.0	7.8	0.15	0.71	0.79
603	W603Z	ZZ	FL603	FLW603Z	ZZ	4.2	5.0	7.8	0.15	0.92	1
623	623Z	ZZ	FL623	FL623Z	ZZ	4.2	5.2	8.8	0.15	1.6	1.8
674A	WA674ASA	SSA	FL674A	FLWA674ASA	SSA	4.6	5.0	6.4	0.08	0.28	0.35
BC4-8	WBC4-8Z	ZZ	FLBC4-8	FLWBC4-8Z	ZZ	4.8	5.0	6.8	0.08	0.38	0.46
684AX50	W684AX50Z	ZZ	FL684AX50	FLW684AX50Z	ZZ	5.0	5.2	7.8	0.1	0.67	0.76
BC4-10	WBC4-10Z	ZZ	FLBC4-10	FLAWBC4-10Z	ZZ	5.2	6.0	8.8	0.15	1	1.1
694	694Z	ZZ	FL694	FL694Z	ZZ	5.2	6.4	9.8	0.15	1.8	2
604	604Z	ZZ	FL604	FL604Z	ZZ	5.6	6.6	10.4	0.2	2.1	2.3
624	624Z	ZZ	FL624	FL624Z	ZZ	5.6	6.2	11.4	0.2	3.2	3.5
634	634Z	ZZ	—	—	—	6	7.6	14	0.3	5.1	—
675	WA675Z	ZZ	FL675	FLWA675Z	ZZ	5.6	6.0	7.4	0.08	0.32	0.4
BC5-9	WBC5-9Z	ZZ	FLBC5-9	FLWBC5-9Z	ZZ	5.2	6.1	7.8	0.15	0.55	0.63
BC5-10	WBC5-10Z	ZZ	FLBC5-10	FLAWBC5-10Z	ZZ	6.2	6.4	8.8	0.15	0.88	0.97

2) This dimension applies to sealed and shielded bearings. 3) Values for double shielded bearings shown.

Miniature and Extra Small Ball Bearings

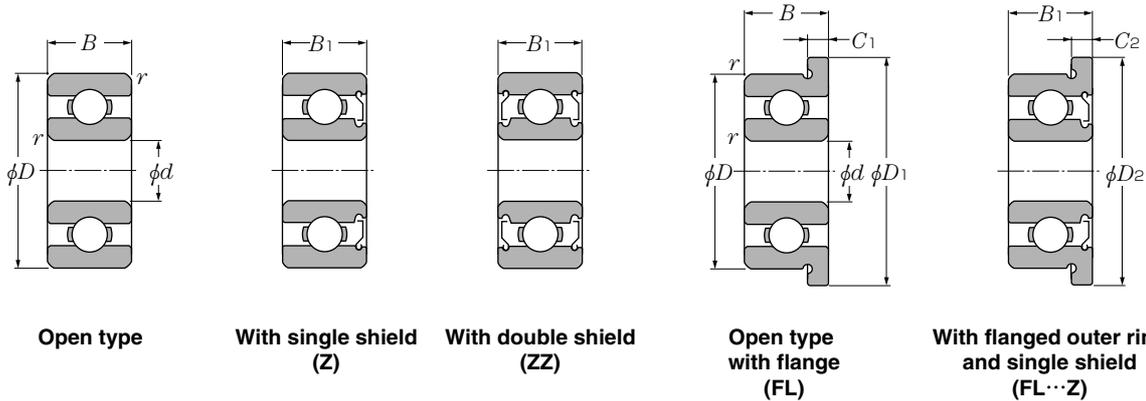

d 5 ~ 9mm

d	Boundary dimensions								Basic load ratings				Factor f_o	Limiting speeds	
	D	B	B ₁	D ₁	D ₂	C ₁	C ₂	$r_{s\ min}^{1)}$	dynamic	static	dynamic	static		grease	oil
									N	C _{or}	kgf	C _{or}			
5	11	—	4	—	12.6	—	0.8	0.15	715	282	73.0	29.0	14.0	43 000	51 000
	11	3	5	12.5	12.5	0.8	1	0.15	715	282	73.0	29.0	14.0	43 000	51 000
	13	4	4	15	15	1	1	0.2	1 080	430	110	44.0	13.4	40 000	47 000
	13	—	5	—	15	—	1	0.2	1 080	430	110	44.0	13.4	40 000	47 000
	14	5	5	16	16	1	1	0.2	1 330	505	135	52.0	12.8	39 000	46 000
	16	5	5	18	18	1	1	0.3	1 760	680	179	69.0	12.4	37 000	44 000
	19	6	6	—	—	—	—	0.3	2 340	885	238	90.0	12.1	34 000	40 000
6	10	2.5	3	11.2	11.2	0.6	0.6	0.1	465	196	47.0	20.0	15.2	43 000	51 000
	12	3	4	13.2	13.6	0.6	0.8	0.15	830	365	85.0	37.0	14.5	40 000	47 000
	13	3.5	5	15	15	1.0	1.1	0.15	1 080	440	110	45.0	13.7	39 000	46 000
	15	5	5	17	17	1.2	1.2	0.2	1 350	530	137	54.0	13.3	37 000	44 000
	16	6	6	—	—	—	—	0.2	1 770	695	181	71.0	12.7	36 000	42 000
	17	6	6	19	19	1.2	1.2	0.3	2 190	865	224	88.0	12.3	35 000	42 000
	19	6	6	22	22	1.5	1.5	0.3	2 340	885	238	90.0	12.1	34 000	40 000
7	11	2.5	3	12.2	12.2	0.6	0.6	0.1	555	269	56.0	27.0	15.6	40 000	47 000
	13	3	4	14.2	14.6	0.6	0.8	0.15	825	375	84.0	38.0	14.9	38 000	45 000
	14	3.5	5	16	16	1	1.1	0.15	1 170	505	120	51.0	14.0	37 000	44 000
	17	5	5	19	19	1.2	1.2	0.3	1 610	715	164	73.0	14.0	35 000	41 000
	19	6	6	—	—	—	—	0.3	2 240	910	228	93.0	12.9	34 000	40 000
	22	7	7	—	—	—	—	0.3	3 350	1 400	340	142	12.5	32 000	37 000
8	12	2.5	3.5	13.2	13.6	0.6	0.8	0.1	515	252	52.0	26.0	15.9	38 000	45 000
	14	3.5	4	15.6	15.6	0.8	0.8	0.15	820	385	84.0	39.0	15.2	36 000	43 000
	16	4	5	18	18	1	1.1	0.2	1 610	715	164	73.0	14.0	35 000	41 000
	19	6	6	22	22	1.5	1.5	0.3	1 990	865	202	88.0	13.8	33 000	39 000
	22	7	7	25	25	1.5	1.5	0.3	3 350	1 400	340	142	12.5	32 000	37 000
	24	8	8	—	—	—	—	0.3	4 000	1 590	410	162	11.7	31 000	36 000
9	14	3	4.5	—	—	—	—	0.1	920	465	94.0	48.0	15.5	36 000	42 000
	17	4	5	19	19	1	1.1	0.2	1 720	820	176	83.0	14.4	33 000	39 000
	20	6	6	—	—	—	—	0.3	2 480	1 090	253	111	13.5	32 000	38 000
	24	7	7	—	—	—	—	0.3	3 400	1 450	345	148	12.9	31 000	36 000
	26	8	8	—	—	—	—	0.6	4 550	1 960	465	200	12.4	30 000	35 000

1) Smallest allowable dimension for chamfer dimension r .

Miniature and Extra Small Ball Bearings

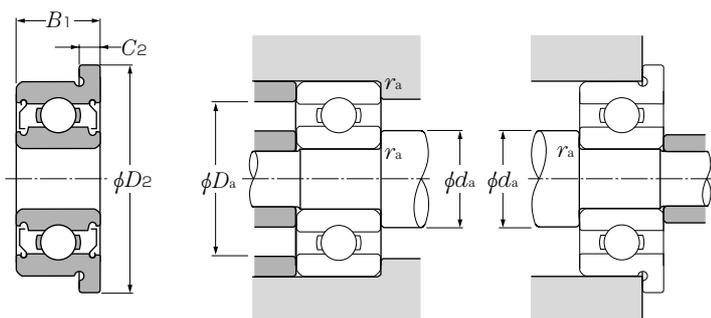

With flanged outer ring and double shield (FL...ZZ)

Dynamic equivalent radial load

$$P_r = X F_r + Y F_a$$

$\frac{f_0 \cdot F_a}{C_{or}}$	e	$\frac{F_a}{F_r} \leq e$		$\frac{F_a}{F_r} > e$	
		X	Y	X	Y
0.172	0.19				2.30
0.345	0.22				1.99
0.689	0.26				1.71
1.03	0.28				1.55
1.38	0.30	1	0	0.56	1.45
2.07	0.34				1.31
3.45	0.38				1.15
5.17	0.42				1.04
6.89	0.44				1.00

Static equivalent radial load

$$P_{or} = 0.6 F_r + 0.5 F_a$$

When $P_{or} < F_r$ use $P_{or} = F_r$

Bearing numbers						Abutment and fillet dimensions				Mass (approx.)	
open	with single shield	with double shield	unsealed type with flange	with flanged OR and single shield	with flanged OR and double shield	mm		r_{as}	g		
						d_a min	d_a max ⁽²⁾	D_a max	max	open	with flange
—	WBC5-11Z	ZZ	—	FLWBC5-11Z	ZZ	6.2	6.8	9.8	0.2	1.8 ⁽³⁾	2 ⁽²⁾
685	W685Z	ZZ	FL685	FLW685Z	ZZ	6.2	6.8	9.8	0.15	1.1	1.3
695	695Z	ZZ	FL695	FL695Z	ZZ	6.6	6.9	11.4	0.2	2.4	2.7
—	WBC5-13Z	ZZ	—	FLWBC5-13Z	ZZ	6.6	6.9	11.4	0.2	3.4 ⁽³⁾	3.7 ⁽³⁾
605	605Z	ZZ	FL605	FL605Z	ZZ	6.6	7.4	12.4	0.2	3.5	3.9
625	625Z	ZZ	FL625	FL625Z	ZZ	7	7.6	14	0.3	4.8	5.2
635	635Z	ZZ	—	—	—	7	9.5	17	0.3	8	—
676A	WA676AZ	ZZ	FL676A	FLWA676AZ	ZZ	6.6	6.7	9.2	0.1	0.65	0.74
BC6-12	WBC6-12Z	ZZ	FLBC6-12	FLAWBC6-12Z	ZZ	7.2	7.9	10.8	0.15	1.3	1.4
686	W686Z	ZZ	FL686	FLW686Z	ZZ	7.0	7.2	11.8	0.15	1.9	2.2
696	696Z	ZZ	FL696	FL696Z	ZZ	7.6	7.8	13.4	0.2	3.8	4.3
BC6-16A	BC6-16AZ	ZZ	—	—	—	7.6	8.0	14.4	0.2	5.2	—
606	606Z	ZZ	FL606	FL606Z	ZZ	8	8.6	15	0.3	6	6.5
626	626Z	ZZ	FL626	FL626Z	ZZ	8	9.5	17	0.3	8.1	9.2
677	WA677Z	ZZ	FL677	FLWA677Z	ZZ	7.8	8.1	10.2	0.1	0.67	0.77
BC7-13	WBC7-13Z	ZZ	FLBC7-13	FLAWBC7-13Z	ZZ	8.2	8.9	11.8	0.15	1.4	1.5
687A	W687AZ	ZZ	FL687A	FLW687AZ	ZZ	8.2	8.7	12.8	0.15	2.1	2.4
697	697Z	ZZ	FL697	FL697Z	ZZ	9	10.0	15	0.3	5.2	5.7
607	607Z	ZZ	—	—	—	9	10.4	17	0.3	8	—
627	627Z	ZZ	—	—	—	9	12.2	20	0.3	13	—
678A	W678AZ	ZZ	FL678A	FLAW678AZ	ZZ	8.8	9.1	11.2	0.1	0.75	0.86
BC8-14	WBC8-14Z	ZZ	FLBC8-14	FLWBC8-14Z	ZZ	9.2	9.5	12.8	0.15	1.8	1.9
688A	W688AZ	ZZ	FL688A	FLW688AZ	ZZ	9.6	10.0	14.4	0.2	3.1	3.5
698	698Z	ZZ	FL698	FL698Z	ZZ	10	10.6	17	0.3	7.3	8.4
608	608Z	ZZ	FL608	FL608Z	ZZ	10	12.2	20	0.3	12	13
628	628Z	ZZ	—	—	—	10	12.1	22	0.3	17	—
679	W679Z	ZZ	—	—	—	9.8	10.4	13.2	0.1	1.4	—
689	W689Z	ZZ	FL689	FLW689Z	ZZ	10.6	10.7	15.4	0.2	3.2	3.6
699	699Z	ZZ	—	—	—	11	11.6	18	0.3	8.2	—
609	609Z	ZZ	—	—	—	11	13.1	22	0.3	14	—
629X50	629X50Z	ZZ	—	—	—	13	13.9	22	0.3	20	—

2) This dimension applies to sealed and shielded bearings. 3) Values for double shielded bearings shown.

Miniature and Extra Small Ball Bearings

Inch series

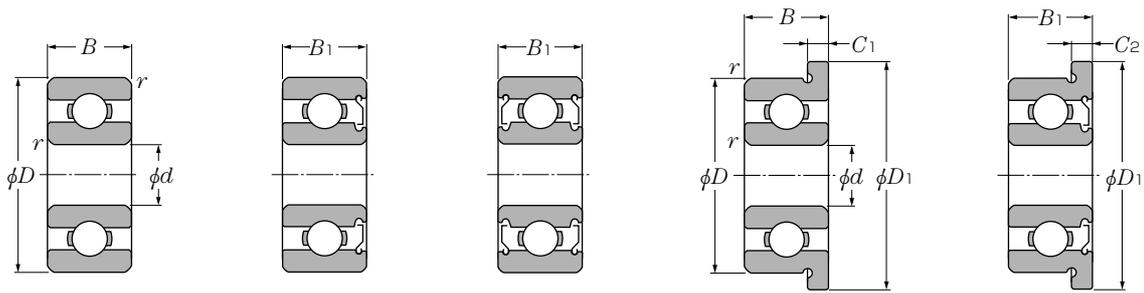

Open type

With single shield (Z)

With double shield (ZZ)

Open type with flange (FL)

With flanged outer ring and single shield (FL...Z)

d 1.984 ~

d	Boundary dimensions							Basic load ratings				Factor f_0	Limiting speeds	
	D	B	B ₁	mm		$r_s \text{ min}^{-1}$)	dynamic	static	dynamic	static	grease		oil	
				D ₁	C ₁		C ₂	N	kgf	kgf		kgf		
1.984	6.35	2.38	3.571	7.52	0.58	0.79	0.08	279	89.0	28	9	12.8	67 000	79 000
	2.380	4.762	1.588	2.38	5.94	0.46	0.79	0.08	124	42.0	13	4.5	14.8	73 000
2.380	7.938	2.779	3.571	9.12	0.58	0.79	0.13	430	152	44	16	13.2	56 000	66 000
	3.175	6.35	2.38	2.779	7.52	0.58	0.79	0.08	284	96.0	29	10	13.7	59 000
7.938		2.779	3.571	9.12	0.58	0.79	0.08	560	180	57	18	11.9	54 000	63 000
9.525		2.779	3.571	10.72	0.58	0.79	0.13	640	224	65	23	12.7	49 000	58 000
9.525		3.967	3.967	11.18	0.76	0.76	0.3	640	224	65	23	12.7	49 000	58 000
3.175	12.7	4.366	4.366	—	—	—	0.3	1 150	395	117	40	11.7	43 000	51 000
	3.967	7.938	2.779	3.175	9.12	0.58	0.91	0.08	335	133	34	14	14.8	51 000
4.762	7.938	2.779	3.175	9.12	0.58	0.91	0.08	395	143	40	15	14.2	49 000	58 000
	9.525	3.175	3.175	10.72	0.58	0.79	0.08	710	268	72	27	13.3	46 000	55 000
	12.7	3.967	—	—	—	—	0.3	1 310	490	134	50	12.4	41 000	48 000
	12.7	4.978	4.978	14.35	1.07	1.07	0.3	1 310	490	134	50	12.4	41 000	48 000
6.350	9.525	3.175	3.175	10.72	0.58	0.91	0.08	210	94.0	21	9.5	16.4	43 000	51 000
	12.7	3.175	4.762	13.89	0.58	1.14	0.13	830	370	84	38	14.7	39 000	46 000
	15.875	4.978	4.978	17.53	1.07	1.07	0.3	1 480	615	151	63	13.6	36 000	43 000
	19.05	—	7.142	—	—	—	0.41	2 340	885	238	90	12.1	34 000	40 000
9.525	22.225	—	7.142	24.61	—	1.57	0.41	3 300	1 400	340	142	12.7	31 000	37 000

1) Smallest allowable dimension for chamfer dimension r.

Miniature and Extra Small Ball Bearings

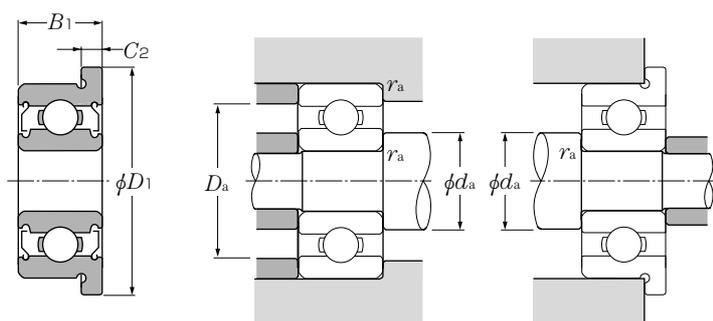

With flanged outer ring and double shield (FL...ZZ)

Dynamic equivalent radial load

$$P_r = X F_r + Y F_a$$

$\frac{f_0 \cdot F_a}{C_{or}}$	e	$\frac{F_a}{F_r} \leq e$		$\frac{F_a}{F_r} > e$	
		X	Y	X	Y
0.172	0.19	1	0	0.56	2.30
0.345	0.22				1.99
0.689	0.26				1.71
1.03	0.28				1.55
1.38	0.30				1.45
2.07	0.34				1.31
3.45	0.38				1.15
5.17	0.42				1.04
6.89	0.44				1.00

Static equivalent radial load

$$P_{or} = 0.6 F_r + 0.5 F_a$$

When $P_{or} < F_r$ use $P_{or} = F_r$

Bearing numbers						Abutment and fillet dimensions				Mass (approx.)	
open	with single shield	with double shield	unsealed type with flange	with flanged OR and single shield	with flanged OR and double shield	mm		r_{as} max	g	g	
					d_a min	d_a max ²⁾	D_a max			open	unsealed type with flange
R1-4	RA1-4ZA	ZZA	FLR1-4	FLRA1-4ZA	ZZA	2.8	3.3	5.5	0.08	0.35	0.41
R133	RA133ZA	ZZA	FLR133	FLRA133ZA	ZZA	2.9	3.1	4	0.08	0.12	0.16
R1-5	RA1-5ZA	ZZA	FLR1-5	FLRA1-5ZA	ZZA	3.2	4.3	7.1	0.1	0.69	0.76
R144	RA144ZA	ZZA	FLR144	FLRA144ZA	ZZA	3.9	4.0	5.5	0.08	0.27	0.33
R2-5	RA2-5Z	ZZ	FLR2-5	FLRA2-5Z	ZZ	4	4.4	7	0.08	0.61	0.68
R2-6	RA2-6ZA	ZZA	FLR2-6	FLRA2-6ZA	ZZA	4	5.2	8.7	0.1	0.88	0.96
R2	RA2ZA	ZZA	FLR2	FLRA2ZA	ZZA	4.8	5.2	7.8	0.3	1.3	1.5
RA2	RA2Z	ZZ	—	—	—	4.8	5.4	11	0.3	2.5	—
R155	RA155ZA	ZZA	FLR155	FLRA155ZA	ZZA	4.8	5.3	7	0.08	0.54	0.61
R156	RA156Z	ZZ	FLR156	FLRA156Z	ZZ	5.5	5.6	7	0.08	0.44	0.51
R166	R166Z	ZZ	FLR166	FLRA166Z	ZZ	5.6	5.9	8.7	0.08	0.8	0.89
R3	—	—	—	—	—	6.4	7.2	11	0.3	2.2	—
RA3	RA3Z	ZZ	FLRA3	FLRA3Z	ZZ	6.0	6.4	11	0.3	2.4	2.7
R168A	R168AZ	AZZ	—	FLRA168AZ	ZZ	7.1	7.3	8.7	0.08	0.6	0.69
R188	RA188ZA	ZZA	FLR188	FLRA188ZA	ZZA	7.2	8.2	11.8	0.1	1.6	1.7
R4	R4Z	ZZ	FLR4	FLR4Z	ZZ	8	8.6	14.2	0.3	4.4	4.8
—	RA4Z	ZZ	—	—	—	8.4	9.5	17	0.4	11 ³⁾	—
—	R6Z	ZZ	—	FLR6Z	ZZ	11.5	11.9	20.2	0.4	14 ³⁾	15 ³⁾

2) This dimension applies to sealed and shielded bearings. 3) Values for double shielded bearings shown.

Miniature and Extra Small Ball Bearings

With Snap Ring Grooves,
Snap Rings

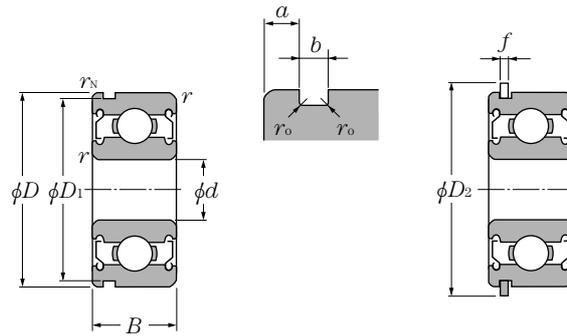

Snap ring groove
Shielded type
(ZZ)

Snap ring
Shielded type
(ZZ)

d 5 ~ 12mm

d	Boundary dimensions				Basic load ratings				Limiting speeds		Bearing numbers		
	D	B	$r_{s \min}^{1)}$	$r_{Na} \min$	dynamic N	static kgf	dynamic kgf	static kgf	f_0	grease	oil	with snap ring groove shielded type	with snap ring shielded type
5	13	4	0.2	0.1	1 080	430	110	44	13.4	40 000	47 000	SC559ZZN	ZZNR
	14	5	0.2	0.2	1 330	505	135	52	12.8	39 000	46 000	SC571ZZN	ZZNR
6	12	4	0.15	0.1	640	365	65	37	14.5	40 000	47 000	* F-SC6A06ZZ1N	ZZ1NR
	13	5	0.15	0.1	1 080	440	110	45	13.7	39 000	46 000	SC6A04ZZN	ZZNR
	15	5	0.2	0.2	1 350	530	137	54	13.3	37 000	44 000	SC6A17ZZN	ZZNR
	19	6	0.3	0.3	2 340	885	238	90	12.1	34 000	40 000	SC669ZZN	ZZNR
8	16	5	0.2	0.1	1 260	585	128	60	14.6	35 000	41 000	SC890ZZN	ZZNR
	22	7	0.3	0.4	3 350	1 400	340	142	12.5	32 000	37 000	SC850ZZN	ZZNR
10	26	8	0.3	0.3	4 550	1 960	465	200	12.4	29 000	34 000	SC0039ZZN	ZZNR
12	28	8	0.3	0.3	5 100	2 390	520	244	13.2	26 000	30 000	SC0142ZZN	ZZNR

1) Smallest allowable dimension for chamfer dimension r.
Note: " * " mark indicates stainless steel is used.

● Miniature and Extra Small Ball Bearings

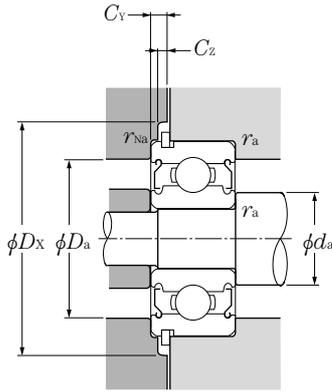

Dynamic equivalent radial load
 $P_r = X F_r + Y F_a$

$\frac{f_0 \cdot F_a}{C_{or}}$	e	$\frac{F_a}{F_r} \leq e$		$\frac{F_a}{F_r} > e$	
		X	Y	X	Y
0.172	0.19				2.30
0.345	0.22				1.99
0.689	0.26				1.71
1.03	0.28				1.55
1.38	0.30	1	0	0.56	1.45
2.07	0.34				1.31
3.45	0.38				1.15
5.17	0.42				1.04
6.89	0.44				1.00

Static equivalent radial load

$P_{or} = 0.6 F_r + 0.5 F_a$

When $P_{or} < F_r$ use $P_{or} = F_r$

Snap ring groove dimensions mm				Snap ring dimensions mm				Abutment and fillet dimensions mm					Mass kg	
D_1 max	a max	b min	r_0 max	D_2 max	f max	d_a min	d_a max	D_a max	D_X (approx.)	C_Y max	C_Z min	r_{as} max	r_{nas} max	with snap ring (approx.)
12.15	0.88	0.55	0.2	15.2	0.55	6.6	6.9	11.4	15.9	1.2	0.6	0.2	0.1	0.002
13.03	1.28	0.65	0.06	16.13	0.54	6.6	7.4	12.4	16.9	1.6	0.6	0.2	0.2	0.004
11.15	0.78	0.60	0.02	14.2	0.55	7.2	7.9	10.8	14.9	1.1	0.6	0.15	0.1	0.001
12.15	1.08	0.55	0.2	15.2	0.55	7.0	7.2	11.8	15.9	1.4	0.6	0.15	0.1	0.002
14.03	1.03	0.65	0.06	17.2	0.60	7.6	7.8	13.4	17.9	1.4	0.7	0.2	0.2	0.004
17.9	0.93	0.80	0.2	22.0	0.70	8.0	9.5	17.0	22.8	1.4	0.7	0.3	0.3	0.008
14.95	0.53	0.65	0.05	18.2	0.54	9.6	10.0	14.4	18.9	0.9	0.6	0.2	0.1	0.003
20.8	2.35	0.80	0.2	24.8	0.70	10.0	12.7	20	25.5	2.8	0.7	0.3	0.4	0.013
24.5	2.20	0.90	0.3	28.8	0.85	12	13.5	24	29.5	2.8	0.9	0.3	0.3	0.02
26.44	2.20	0.90	0.3	32.7	0.85	14	16	26	33.4	2.8	0.9	0.3	0.3	0.022



سنگین
چرخ صنعت کشور

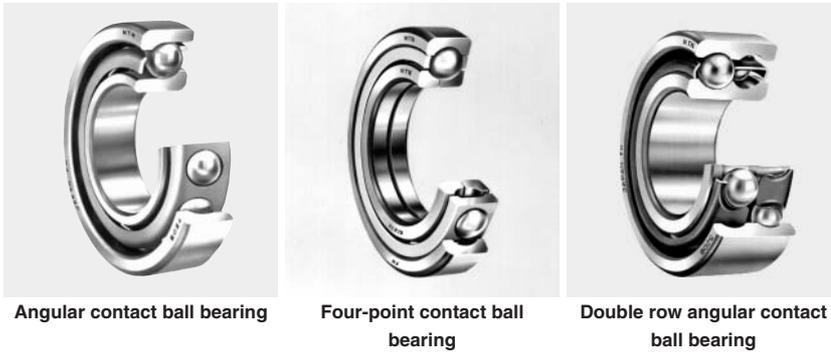

1. Design features and special characteristics

1.1 Angular contact ball bearing

Angular contact ball bearings are non-separable bearings which have a certain contact angle in the radial direction relative to the straight line that runs through the point where each ball makes contact with the inner and outer rings (see **Diagram 1**). **Table 1** gives contact angle and contact angle symbol.

In addition to radial loads, single direction axial loads can also be accommodated by angular contact ball bearings.

Furthermore, since an axial load is generated from a radial force, these bearings are generally used in pairs facing each other. Standard type, high speed use type and ultra high speed varieties of angular contact ball bearings are available through NTN, and there are also many duplex varieties. A bearing accuracy of JIS Class 5 or higher is applied to duplex type angular contact ball bearings, and in many cases they are given a preload, in compliance with standard preload levels,

before being used in an application. **Table 2** shows information concerning angular contact ball bearings, and **Table 3** shows similar information for duplex angular contact ball bearings.

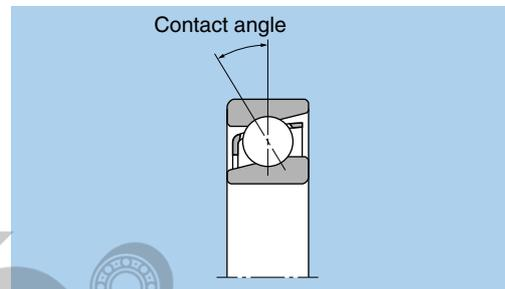

Diagram 1.

Table 1 Contact angle and contact angle codes

Contact angle	15°	30°	40°
Code	C	A ^①	B

① Contact angle symbol A is omitted.

Table 2 Angular contact ball bearing types and characteristics

Type	Design	Characteristics
Standard type		<ul style="list-style-type: none"> Available in bearing series 79, 70, 72, 72B, 73, and 73B. Contact angles: 30° and 40° (with B) available. Standard bearing cage type differs depending on bearing no. (Refer to Table 4)

Table 3 Duplex angular contact ball bearings — types and characteristics

Duplex type		Characteristics
Back-to-back duplex (DB)		<ul style="list-style-type: none"> Can accommodate radial loads and axial loads in either direction. Has a large distance l between the acting load center of the bearing, and therefore a large momentary force load capacity. Allowable misalignment angle is small.
Face-to-face duplex (DF)		<ul style="list-style-type: none"> Can accommodate radial loads and axial loads in either direction. Has a smaller distance l between the acting load center of the bearing, and therefore a smaller momentary force load capacity. Has a larger allowable misalignment angle than back-to-back duplex type.
Tandem duplex (DT)		<ul style="list-style-type: none"> Can accommodate radial loads and single direction axial loads. Axial loads are received by both bearings as a set, and therefore heavy axial loads can be accommodated.

Note: 1. Duplex bearings are manufactured in a set to specified clearance and preload values, therefore they must be assembled together with identically numbered bearings and not mixed with other arrangements.

2. Triplex arrangements of angular contact bearings are also available. Consult NTN Engineering for details.

1.2 Four-point angular contact ball bearings

Four-point angular contact ball bearings have a contact angle of 30° and inner rings which are separated in half. As shown in **Diagram 2**, when the inner and outer rings receive a radial load the ball bearings contact the inner and outer rings at four points. This construction enables a single bearing to accommodate axial loads from either direction, and when generally under a simple axial load or heavy axial load, the bearing functions in reliance on two contact points like ordinary bearings.

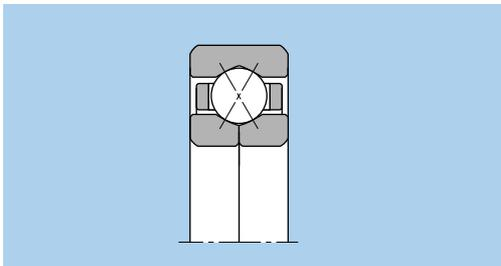

Diagram 2.

1.3 Double row angular contact ball bearings

The structure of double row angular contact ball bearings is designed by arranging two single row angular contact bearings back-to-back in duplex (DB) to form one united bearing with a contact angle of 25°.

These bearings are capable of accommodating radial loads, axial loads in either direction, and have a high capacity for momentary loads as well.

As shown in **Diagram 3**, sealed and shielded type double row angular contact ball bearings are also available. Standard loads vary from those of open type bearings.

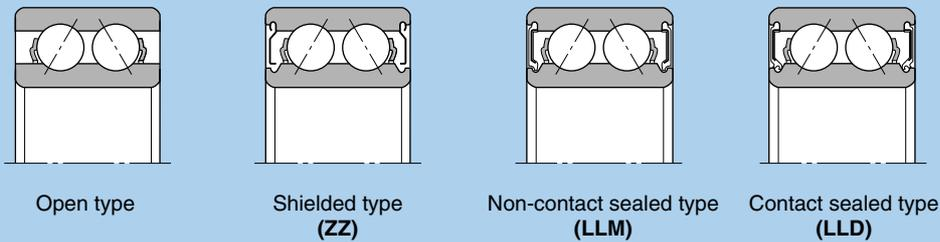

Diagram 3.

Flush ground

"Flush ground" is the name given to the finishing method shown in **Diagram 4** where the offset of the front and back faces of the bearing are ground to the same value. By doing this, a stated clearance or preload value can be achieved by using bearings with identical codes for these values, in other words by combining either DB or DF series bearings. DT series bearings can also be used in various arrangements to achieve uniform load distribution.

All BNT type bearings are flush ground, but other angular contact ball bearing series are not. If it is necessary to flush grind any of these other bearings, please consult NTN Engineering.

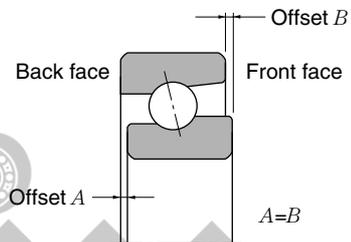

Diagram 4.

2. Standard cage types

Table 4 lists the standard cage types for angular contact ball bearings.

Table 4 Standard cages for angular contact ball bearings

Type	Bearing series	Molded resin cage	Pressed cage	Machined cage
Standard	79	7904~7913	—	7914 ~7960
	70	7000~7024	—	7026 ~7040
	72	—	7200 ~7222	7224 ~7240
	73	—	7300 ~7322	7324 ~7340
	72B	—	7200B~7222B	7224B ~7240B
	73B	—	7300B~7322B	7324B ~7340B
4-point contact	QJ2	—	—	QJ208 ~QJ224
	QJ3	—	—	QJ306 ~QJ324
Double row	52	—	5200S~5217S	—
	53	—	5302S~5314S	—

Note: Due to the material characteristics of molded resin cages, use at application temperatures in excess of 120°C is not possible.



Single and Duplex Angular Contact Ball Bearings

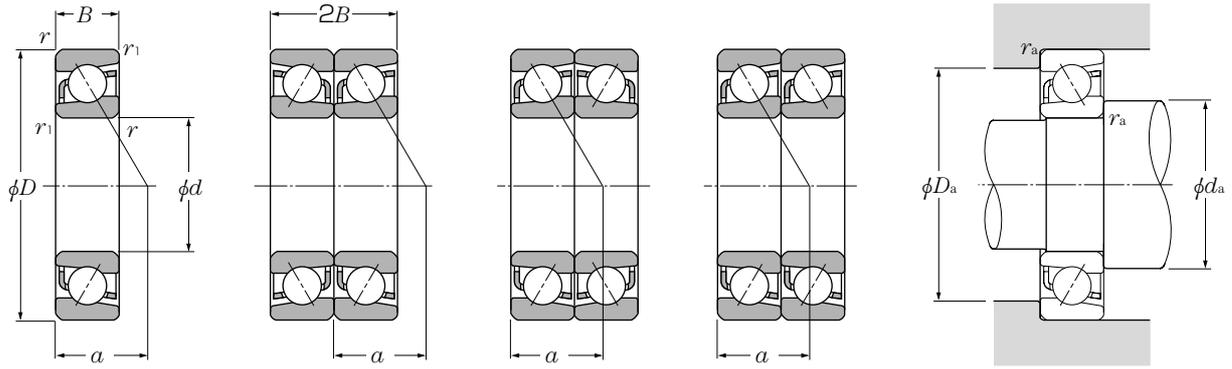

Single

Back-to-back arrangement (DB)

Face-to-face arrangement (DF)

Tandem arrangement (DT)

d 10 ~ 30mm

d	Boundary dimensions					Basic load ratings				Limiting speeds ¹⁾		Bearing ²⁾ numbers	Load center mm a	Mass kg single (approx.)
	D	B	2B	$r_s \text{ min}^{(3)}$	$r_{1s} \text{ min}^{(3)}$	dynamic kN C_r	static kN C_{or}	dynamic kgf C_r	static kgf C_{or}	grease min ⁻¹	oil min ⁻¹			
10	26	8	16	0.3	0.15	4.65	2.07	470	212	29 000	39 000	7000	9	0.023
	30	9	18	0.6	0.3	5.45	2.74	555	279	28 000	37 000	7200	10.5	0.029
	30	9	18	0.6	0.3	5.00	2.52	510	257	24 000	32 000	7200B	13	0.029
	35	11	22	0.6	0.3	10.1	4.95	1 030	500	26 000	34 000	7300	12	0.04
	35	11	22	0.6	0.3	9.50	4.60	970	470	22 000	29 000	7300B	15	0.041
12	28	8	16	0.3	0.15	5.05	2.46	515	251	26 000	35 000	7001	10	0.025
	32	10	20	0.6	0.3	7.60	3.95	775	405	25 000	33 000	7201	11.5	0.035
	32	10	20	0.6	0.3	7.00	3.65	775	405	21 000	28 000	7201B	14	0.036
	37	12	24	1	0.6	11.2	5.25	1 140	535	23 000	30 000	7301	13	0.044
	37	12	24	1	0.6	10.5	4.95	1 080	505	19 000	26 000	7301B	16.5	0.045
15	32	9	18	0.3	0.15	5.80	3.15	590	320	23 000	31 000	7002	11.5	0.035
	35	11	22	0.6	0.3	9.05	4.70	925	480	22 000	29 000	7202	12.5	0.046
	35	11	22	0.6	0.3	8.35	4.35	855	445	18 000	25 000	7202B	16	0.046
	42	13	26	1	0.6	13.5	7.20	1 370	735	19 000	26 000	7302	15	0.055
	42	13	26	1	0.6	12.5	6.65	1 270	680	17 000	22 000	7302B	19	0.057
17	35	10	20	0.3	0.15	7.15	3.85	730	390	21 000	28 000	7003	12.5	0.046
	40	12	24	0.6	0.3	12.0	6.60	1 220	675	19 000	26 000	7203	14.5	0.064
	40	12	24	0.6	0.3	11.0	6.10	1 120	625	17 000	22 000	7203B	18	0.066
	47	14	28	1	0.6	15.9	8.65	1 630	880	18 000	24 000	7303	16	0.107
	47	14	28	1	0.6	14.8	8.00	1 510	820	15 000	20 000	7303B	20.5	0.109
20	42	12	24	0.6	0.3	9.70	5.60	990	570	19 000	25 000	7004	15	0.08
	47	14	28	1	0.6	14.5	8.40	1 480	855	17 000	23 000	7204	17	0.1
	47	14	28	1	0.6	13.3	7.70	1 360	785	15 000	20 000	7204B	21.5	0.102
	52	15	30	1.1	0.6	18.7	10.4	1 910	1 060	16 000	21 000	7304	18	0.138
	52	15	30	1.1	0.6	17.3	9.65	1 770	985	13 000	18 000	7304B	22.5	0.141
25	42	9	18	0.3	0.15	7.15	4.95	730	505	17 000	22 000	7905	14	0.05
	47	12	24	0.6	0.3	10.7	6.85	1 100	700	16 000	21 000	7005	16.5	0.093
	52	15	30	1	0.6	16.2	10.3	1 650	1 050	14 000	19 000	7205	19	0.125
	52	15	30	1	0.6	14.8	9.40	1 510	960	12 000	16 000	7205B	24	0.129
	62	17	34	1.1	0.6	26.4	15.8	2 690	1 610	13 000	17 000	7305	21	0.23
	62	17	34	1.1	0.6	24.4	14.6	2 490	1 490	11 000	15 000	7305B	27	0.234
30	47	9	18	0.3	0.15	7.55	5.75	770	585	14 000	19 000	7906	15.5	0.058
	55	13	26	1	0.6	13.9	9.45	1 410	965	13 000	18 000	7006	19	0.135

1) This value achieved with machined cages; when pressed cages are used, 80% of this value is acceptable.
 2) Bearing numbers appended with the code "B" have a contact angle of 40°; bearings with this code have a contact angle of 30°.
 3) Smallest allowable dimension for chamfer dimension r.

Single and Duplex Angular Contact Ball Bearings

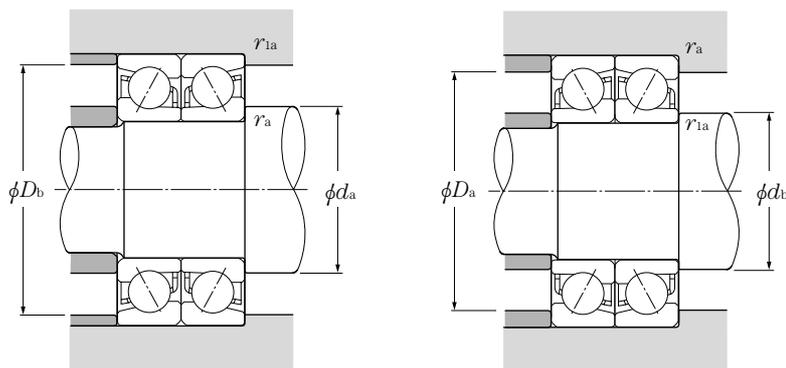

Dynamic equivalent radial load

$$P_r = X F_r + Y F_a$$

Contact angle	e	Single, DT				DB, DF			
		$F_a/F_r \leq e$		$F_a/F_r > e$		$F_a/F_r \leq e$		$F_a/F_r > e$	
		X	Y	X	Y	X	Y	X	Y
30°	0.80	1	0	0.39	0.76	1	0.78	0.63	1.24
40°	1.14	1	0	0.35	0.57	1	0.55	0.57	0.93

Static equivalent radial load

$$P_{or} = X_0 F_r + Y_0 F_a$$

Contact angle	Single, DT		DB, DF	
	X_0	Y_0	X_0	Y_0
30°	0.5	0.33	1	0.66
40°	0.5	0.26	1	0.52

For single and DT arrangement,
When $P_{or} < F_r$ use $P_{or} = F_r$

Basic load ratings				Limiting speeds ¹⁾		Bearing numbers ²⁾			Abutment and fillet dimensions					
dynamic (duplex) kN	static kN	dynamic (duplex) kgf	static kgf	(duplex) min ⁻¹		DB	DF	DT	mm					
C_r	C_{or}	C_r	C_{or}	grease	oil				d_a min	d_b min	D_a max	D_b max	r_{as} max	r_{1as} max
7.50	4.15	765	425	23 000	31 000	DB	DF	DT	12.5	12.5	23.5	24.8	0.3	0.15
8.80	5.45	900	560	22 000	30 000	DB	DF	DT	14.5	12.5	25.5	27.5	0.6	0.3
8.10	5.05	825	515	19 000	26 000	DB	DF	DT	14.5	12.5	25.5	27.5	0.6	0.3
16.5	9.85	1 680	1 000	20 000	27 000	DB	DF	DT	14.5	12.5	30.5	32.5	0.6	0.3
15.4	9.20	1 570	940	18 000	24 000	DB	DF	DT	14.5	12.5	30.5	32.5	0.6	0.3
8.20	4.90	840	500	21 000	28 000	DB	DF	DT	14.5	14.5	25.5	26.8	0.3	0.15
12.3	7.95	1 260	810	20 000	26 000	DB	DF	DT	16.5	14.5	27.5	29.5	0.6	0.3
11.4	7.35	1 160	750	17 000	23 000	DB	DF	DT	16.5	14.5	27.5	29.5	0.6	0.3
18.2	10.5	1 850	1 070	18 000	24 000	DB	DF	DT	17.5	16.5	31.5	32.5	1	0.6
17.1	9.90	1 750	1 010	16 000	21 000	DB	DF	DT	17.5	16.5	31.5	32.5	1	0.6
9.40	6.30	960	640	18 000	24 000	DB	DF	DT	17.5	17.5	29.5	30.8	0.3	0.15
14.7	9.40	1 500	960	17 000	23 000	DB	DF	DT	19.5	17.5	30.5	32.5	0.6	0.3
13.6	8.70	1 390	885	15 000	20 000	DB	DF	DT	19.5	17.5	30.5	32.5	0.6	0.3
21.9	14.4	2 230	1 470	15 000	21 000	DB	DF	DT	20.5	19.5	36.5	37.5	1	0.6
20.3	13.3	2 070	1 360	13 000	18 000	DB	DF	DT	20.5	19.5	36.5	37.5	1	0.6
11.6	7.65	1 190	780	17 000	22 000	DB	DF	DT	19.5	19.5	32.5	33.8	0.3	0.15
19.4	13.2	1 980	1 350	15 000	21 000	DB	DF	DT	21.5	19.5	35.5	37.5	0.6	0.3
17.9	12.2	1 830	1 250	13 000	18 000	DB	DF	DT	21.5	19.5	35.5	37.5	0.6	0.3
25.9	17.3	2 640	1 760	14 000	19 000	DB	DF	DT	22.5	21.5	41.5	42.5	1	0.6
24.0	16.0	2 450	1 640	12 000	16 000	DB	DF	DT	22.5	21.5	41.5	42.5	1	0.6
15.8	11.2	1 610	1 140	15 000	20 000	DB	DF	DT	24.5	24.5	37.5	39.5	0.6	0.3
23.6	16.8	2 400	1 710	14 000	18 000	DB	DF	DT	25.5	24.5	41.5	42.5	1	0.6
21.6	15.4	2 200	1 570	12 000	16 000	DB	DF	DT	25.5	24.5	41.5	42.5	1	0.6
30.5	20.8	3 100	2 130	12 000	17 000	DB	DF	DT	27	24.5	45	47.5	1	0.6
28.2	19.3	2 870	1 970	11 000	14 000	DB	DF	DT	27	24.5	45	47.5	1	0.6
11.6	9.95	1 180	1 010	13 000	18 000	DB	DF	DT	27.5	27.5	39.5	40.8	0.3	0.15
17.5	13.7	1 780	1 400	12 000	17 000	DB	DF	DT	29.5	29.5	42.5	44.5	0.6	0.3
26.3	20.6	2 690	2 100	11 000	15 000	DB	DF	DT	30.5	29.5	46.5	47.5	1	0.6
24.0	18.8	2 450	1 920	10 000	13 000	DB	DF	DT	30.5	29.5	46.5	47.5	1	0.6
43.0	31.5	4 400	3 250	10 000	14 000	DB	DF	DT	32	29.5	55	57.5	1	0.6
39.5	29.3	4 050	2 980	9 100	12 000	DB	DF	DT	32	29.5	55	57.5	1	0.6
12.3	11.5	1 250	1 170	12 000	15 000	DB	DF	DT	32.5	32.5	44.5	45.8	0.3	0.15
22.5	18.9	2 300	1 930	11 000	14 000	DB	DF	DT	35.5	35.5	49.5	50.5	1	0.6

Note: For bearing series 79 and 70, inner rings are constructed with groove abutments on both sides. Therefore, the inner ring chamfer dimension r_1 is identical to dimension r . Furthermore, the radius r_{1a} of the shaft corner roundness is likewise identical to r_a .

Single and Duplex Angular Contact Ball Bearings

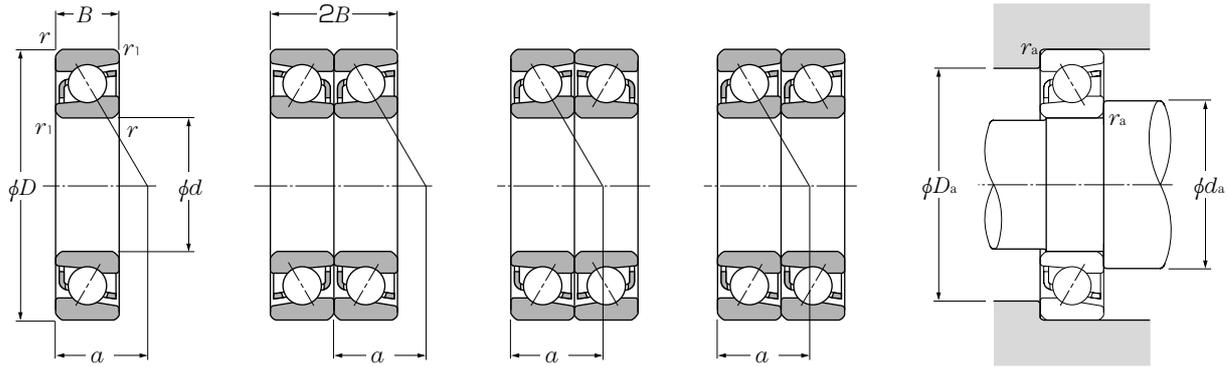

Single

Back-to-back arrangement (DB)

Face-to-face arrangement (DF)

Tandem arrangement (DT)

d 30 ~ 55mm

d	Boundary dimensions					Basic load ratings				Limiting speeds ¹⁾		Bearing ²⁾ numbers	Load center mm a	Mass kg single (approx.)
	D	B	2B	$r_s \text{ min}^{(3)}$	$r_{1s} \text{ min}^{(3)}$	dynamic kN C_r	static kN C_{or}	dynamic kgf C_r	static kgf C_{or}	grease min ⁻¹	oil min ⁻¹			
30	62	16	32	1	0.6	22.5	14.8	2 300	1 510	12 000	16 000	7206	21.5	0.193
	62	16	32	1	0.6	20.5	13.5	2 090	1 380	11 000	14 000	7206B	27.5	0.197
	72	19	38	1.1	0.6	33.5	22.3	3 450	2 280	11 000	15 000	7306	24.5	0.345
	72	19	38	1.1	0.6	31.0	20.5	3 150	2 090	9 600	13 000	7306B	31.5	0.352
35	55	10	20	0.6	0.3	12.0	8.85	1 220	905	13 000	17 000	7907	18	0.088
	62	14	28	1	0.6	17.5	12.6	1 790	1 280	12 000	16 000	7007	21	0.18
	72	17	34	1.1	0.6	29.7	20.1	3 050	2 050	11 000	14 000	7207	24	0.281
	72	17	34	1.1	0.6	27.1	18.4	2 760	1 870	9 300	12 000	7207B	31	0.287
	80	21	42	1.5	1	40.0	26.3	4 050	2 680	9 800	13 000	7307	27	0.462
	80	21	42	1.5	1	36.5	24.2	3 750	2 470	8 400	11 000	7307B	34.5	0.469
40	62	12	24	0.6	0.3	12.7	10.2	1 290	1 040	11 000	15 000	7908	20.5	0.13
	68	15	30	1	0.6	18.8	14.6	1 910	1 490	10 000	14 000	7008	23	0.222
	80	18	36	1.1	0.6	35.5	25.1	3 600	2 560	9 600	13 000	7208	26.5	0.355
	80	18	36	1.1	0.6	32.0	23.0	3 250	2 340	8 300	11 000	7208B	34	0.375
	90	23	46	1.5	1	49.0	33.0	5 000	3 350	8 600	12 000	7308	30.5	0.625
	90	23	46	1.5	1	45.0	30.5	4 550	3 100	7 400	9 900	7308B	39	0.636
45	68	12	24	0.6	0.3	15.7	12.9	1 600	1 310	10 000	14 000	7909	22.5	0.15
	75	16	32	1	0.6	22.3	17.7	2 270	1 800	9 500	13 000	7009	25.5	0.282
	85	19	38	1.1	0.6	39.5	28.7	4 050	2 930	8 700	12 000	7209	28.5	0.404
	85	19	38	1.1	0.6	36.0	26.2	3 650	2 680	7 400	9 900	7209B	37	0.41
	100	25	50	1.5	1	63.5	44.0	6 450	4 500	7 800	10 000	7309	33.5	0.837
	100	25	50	1.5	1	58.5	40.0	5 950	4 100	6 600	8 900	7309B	43.0	0.854
50	72	12	24	0.6	0.3	16.6	14.5	1 690	1 470	9 200	12 000	7910	23.5	0.157
	80	16	32	1	0.6	23.7	20.1	2 410	2 050	8 600	11 000	7010	27	0.306
	90	20	40	1.1	0.6	41.5	31.5	4 200	3 200	7 900	10 000	7210	30	0.457
	90	20	40	1.1	0.6	37.5	28.6	3 800	2 920	6 700	9 000	7210B	39.5	0.466
	110	27	54	2	1	74.5	52.5	7 600	5 350	7 100	9 400	7310	36.5	1.09
	110	27	54	2	1	68.0	48.0	6 950	4 950	6 000	8 100	7310B	47	1.11
55	80	13	26	1	0.6	17.3	16.1	1 770	1 640	8 400	11 000	7911	26	0.214
	90	18	36	1.1	0.6	31.0	26.3	3 150	2 680	7 900	11 000	7011	30	0.447
	100	21	42	1.5	1	51.0	39.5	5 200	4 050	7 100	9 500	7211	33	0.6
	100	21	42	1.5	1	46.5	36.0	4 700	3 700	6 100	8 200	7211B	43	0.612
	120	29	58	2	1	86.0	61.5	8 750	6 300	6 400	8 600	7311	40	1.39
	120	29	58	2	1	79.0	56.5	8 050	5 800	5 500	7 300	7311B	52	1.42

1) This value achieved with machined cages; when pressed cages are used, 80% of this value is acceptable.
 2) Bearing numbers appended with the code "B" have a contact angle of 40°; bearings with this code have a contact angle of 30°.
 3) Smallest allowable dimension for chamfer dimension r or r_1 .

Single and Duplex Angular Contact Ball Bearings

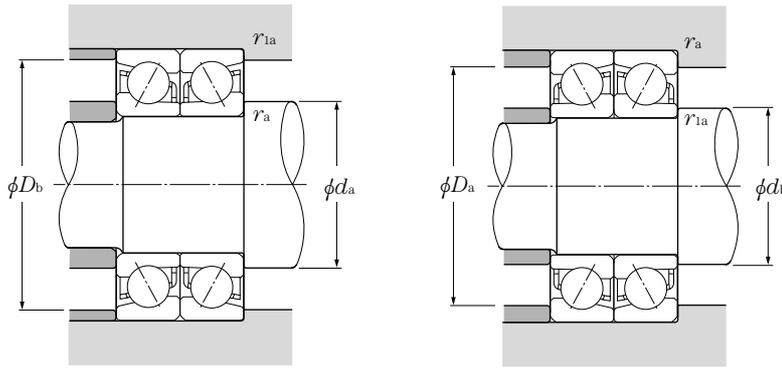

Dynamic equivalent radial load

$$P_r = X F_r + Y F_a$$

Contact angle	e	Single, DT				DB, DF			
		$F_a/F_r \leq e$		$F_a/F_r > e$		$F_a/F_r \leq e$		$F_a/F_r > e$	
		X	Y	X	Y	X	Y	X	Y
30°	0.80	1	0	0.39	0.76	1	0.78	0.63	1.24
40°	1.14	1	0	0.35	0.57	1	0.55	0.57	0.93

Static equivalent radial load

$$P_{or} = X_0 F_r + Y_0 F_a$$

Contact angle	Single, DT		DB, DF	
	X_0	Y_0	X_0	Y_0
30°	0.5	0.33	1	0.66
40°	0.5	0.26	1	0.52

For single and DT arrangement,
When $P_{or} < F_r$ use $P_{or} = F_r$

Basic load ratings				Limiting speeds ¹⁾		Bearing numbers ²⁾			Abutment and fillet dimensions					
dynamic (duplex) kN	static kN	dynamic (duplex) kgf	static kgf	(duplex) min ⁻¹		DB	DF	DT	mm					
C_r	C_{or}	C_r	C_{or}	grease	oil				d_a min	d_b min	D_a max	D_b max	r_{as} max	r_{1as} max
36.5	29.6	3 750	3 000	9 800	13 000	DB	DF	DT	35.5	34.5	56.5	57.5	1	0.6
33.5	27.1	3 400	2 760	8 600	11 000	DB	DF	DT	35.5	34.5	56.5	57.5	1	0.6
54.5	44.5	5 550	4 550	8 900	12 000	DB	DF	DT	37	34.5	65	67.5	1	0.6
50.0	41.0	5 100	4 200	7 700	10 000	DB	DF	DT	37	34.5	65	67.5	1	0.6
19.5	17.7	1 990	1 810	10 000	13 000	DB	DF	DT	39.5	39.5	50.5	52.5	0.6	0.3
28.5	25.1	2 900	2 560	9 400	13 000	DB	DF	DT	40.5	40.5	56.5	57.5	1	0.6
48.5	40.0	4 900	4 100	8 600	11 000	DB	DF	DT	42	39.5	65	67.5	1	0.6
44.0	36.5	4 500	3 750	7 500	10 000	DB	DF	DT	42	39.5	65	67.5	1	0.6
65.0	52.5	6 600	5 350	7 800	10 000	DB	DF	DT	43.5	40.5	71.5	74.5	1.5	1
59.5	48.5	6 100	4 950	6 800	9 000	DB	DF	DT	43.5	40.5	71.5	74.5	1.5	1
20.6	20.4	2 100	2 080	9 000	12 000	DB	DF	DT	44.5	44.5	57.5	59.5	0.6	0.3
30.5	29.2	3 100	2 970	8 300	11 000	DB	DF	DT	45.5	45.5	62.5	63.5	1	0.6
57.5	50.5	5 850	5 150	7 700	10 000	DB	DF	DT	47	44.5	73.0	75.5	1	0.6
52.0	46.0	5 300	4 700	6 700	8 900	DB	DF	DT	47	44.5	73	75.5	1	0.6
79.5	66.0	8 100	6 700	6 900	9 200	DB	DF	DT	48.5	45.5	81.5	84.5	1.5	1
73.0	60.5	7 400	6 200	6 000	8 000	DB	DF	DT	48.5	45.5	81.5	84.5	1.5	1
25.5	25.7	2 600	2 620	8 100	11 000	DB	DF	DT	49.5	49.5	63.5	65.5	0.6	0.3
36.0	35.5	3 700	3 600	7 500	10 000	DB	DF	DT	50.5	50.5	69.5	70.5	1	0.6
64.5	57.5	6 550	5 850	6 900	9 200	DB	DF	DT	52	49.5	78	80.5	1	0.6
58.5	52.5	5 950	5 350	6 000	8 000	DB	DF	DT	52	49.5	78	80.5	1	0.6
103	88.0	10 500	8 950	6 200	8 200	DB	DF	DT	53.5	50.5	91.5	94.5	1.5	1
95.0	80.5	9 650	8 250	5 400	7 200	DB	DF	DT	53.5	50.5	91.5	94.5	1.5	1
27.0	28.9	2 750	2 950	7 300	9 800	DB	DF	DT	54.5	54.5	67.5	69.5	0.6	0.3
38.5	40.0	3 900	4 100	6 800	9 100	DB	DF	DT	55.5	55.5	74.5	75.5	1	0.6
67.0	63.0	6 850	6 400	6 300	8 300	DB	DF	DT	57	54.5	83	85.5	1	0.6
60.5	57.0	6 200	5 850	5 500	7 300	DB	DF	DT	57	54.5	83	85.5	1	0.6
121	105	12 300	10 700	5 600	7 500	DB	DF	DT	60	55.5	100	104.5	2	1
111	96.0	11 300	9 850	4 900	6 500	DB	DF	DT	60	55.5	100	104.5	2	1
28.1	32.0	2 870	3 300	6 700	8 900	DB	DF	DT	60.5	60.5	74.5	75.5	1	0.6
50.5	52.5	5 150	5 350	6 300	8 400	DB	DF	DT	62	62	83	85.5	1	0.6
83.0	79.0	8 450	8 050	5 700	7 600	DB	DF	DT	63.5	60.5	91.5	94.5	1.5	1
75.0	72.0	7 650	7 350	5 000	6 600	DB	DF	DT	63.5	60.5	91.5	94.5	1.5	1
139	123	14 200	12 600	5 100	6 800	DB	DF	DT	65	60.5	110	114.5	2	1
128	113	13 000	11 600	4 500	5 900	DB	DF	DT	65	60.5	110	114.5	2	1

Note: For bearing series 79 and 70, inner rings are constructed with groove abutments on both sides. Therefore, the inner ring chamfer dimension r_1 is identical to dimension r . Furthermore, the radius r_{1a} of the shaft corner roundness is likewise identical to r_a .

Single and Duplex Angular Contact Ball Bearings

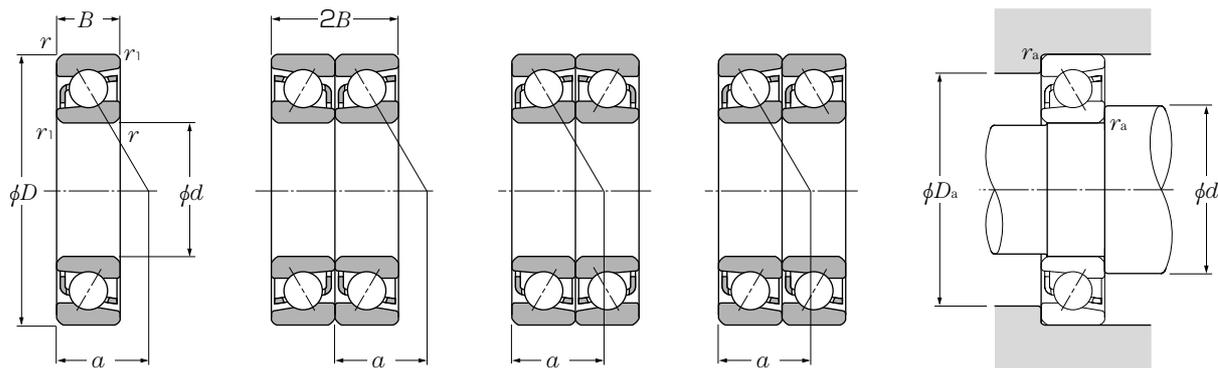

Single

Back-to-back arrangement (DB)

Face-to-face arrangement (DF)

Tandem arrangement (DT)

d 60 ~ 85mm

d	Boundary dimensions					Basic load ratings				Limiting speeds ¹⁾		Bearing ²⁾ numbers	Load center mm a	Mass kg single (approx.)
	D	B	2B	r _s min ³⁾	r _{rs} min ³⁾	dynamic kN C _r	static kN C _{or}	dynamic kgf C _r	static kgf C _{or}	grease	oil			
60	85	13	26	1	0.6	18.1	17.4	1 840	1 780	7 800	10 000	7912	27.5	0.23
	95	18	36	1.1	0.6	32.0	28.1	3 250	2 860	7 200	9 600	7012	31.5	0.478
	110	22	44	1.5	1	61.5	49.0	6 300	5 000	6 600	8 800	7212	36	0.765
	110	22	44	1.5	1	56.0	44.5	5 700	4 550	5 700	7 600	7212B	47.5	0.78
	130	31	62	2.1	1.1	98.0	71.5	10 000	7 300	5 900	7 900	7312	43	1.74
	130	31	62	2.1	1.1	90.0	66.0	9 200	6 700	5 100	6 800	7312B	56	1.77
65	90	13	26	1	0.6	18.3	18.0	1 860	1 840	7 200	9 600	7913	29	0.245
	100	18	36	1.1	0.6	33.5	31.5	3 450	3 200	6 700	9 000	7013	33	0.509
	120	23	46	1.5	1	70.5	58.0	7 150	5 900	6 100	8 100	7213	38	0.962
	120	23	46	1.5	1	63.5	52.5	6 500	5 350	5 200	7 000	7213B	50.5	0.981
	140	33	66	2.1	1.1	111	82.0	11 300	8 350	5 500	7 300	7313	46	2.11
	140	33	66	2.1	1.1	102	75.0	10 400	7 700	4 700	6 300	7313B	59.5	2.15
70	100	16	32	1	0.6	26.2	26.2	2 670	2 670	6 700	9 000	7914	32.5	0.397
	110	20	40	1.1	0.6	42.5	39.5	4 350	4 000	6 200	8 300	7014	36	0.705
	125	24	48	1.5	1	76.5	63.5	7 800	6 500	5 700	7 600	7214	40	1.09
	125	24	48	1.5	1	69.0	58.0	7 050	5 900	4 900	6 500	7214B	53	1.11
	150	35	70	2.1	1.1	125	93.5	12 700	9 550	5 100	6 800	7314	49.5	2.56
	150	35	70	2.1	1.1	114	86	11 700	8 800	4 400	5 800	7314B	63.5	2.61
75	105	16	32	1	0.6	26.50	27.1	2 710	2 760	6 300	8 400	7915	34	0.42
	115	20	40	1.1	0.6	43.50	41.5	4 450	4 250	5 800	7 800	7015	37.5	0.745
	130	25	50	1.5	1	79.0	68.5	8 050	7 000	5 300	7 100	7215	42.5	1.17
	130	25	50	1.5	1	71.5	62.0	7 300	6 350	4 500	6 000	7215B	56	1.19
	160	37	74	2.1	1.1	136	106	13 800	10 800	4 800	6 300	7315	52.5	3.07
	160	37	74	2.1	1.1	125	97.5	12 700	9 900	4 100	5 400	7315B	68	3.13
80	110	16	32	1	0.6	26.9	28.0	2 740	2 860	5 900	7 800	7916	35.5	0.444
	125	22	44	1.1	0.6	53.5	50.5	5 450	5 150	5 500	7 300	7016	40.5	0.994
	140	26	52	2	1	89.0	76.0	9 100	7 750	5 000	6 600	7216	45	1.39
	140	26	52	2	1	80.5	69.5	8 200	7 050	4 300	5 700	7216B	59	1.42
	170	39	78	2.1	1.1	147	119	15 000	12 100	4 500	5 900	7316	55.5	3.65
	170	39	78	2.1	1.1	135	109	13 800	11 100	3 800	5 100	7316B	72	3.72
85	120	18	36	1.1	0.6	36.0	38.0	3 700	3 850	5 500	7 400	7917	38.5	0.628
	130	22	44	1.1	0.6	54.5	53.5	5 600	5 450	5 100	6 900	7017	42	1.04
	150	28	56	2	1	99.5	88.5	10 100	9 050	4 700	6 200	7217	48	1.78
	150	28	56	2	1	90.0	80.5	9 150	8 200	4 000	5 300	7217B	63.5	1.82

1) This value achieved with machined cages; when pressed cages are used, 80% of this value is acceptable.
 2) Bearing numbers appended with the code "B" have a contact angle of 40°; bearings with this code have a contact angle of 30°.
 3) Smallest allowable dimension for chamfer dimension r or r₁.

Single and Duplex Angular Contact Ball Bearings

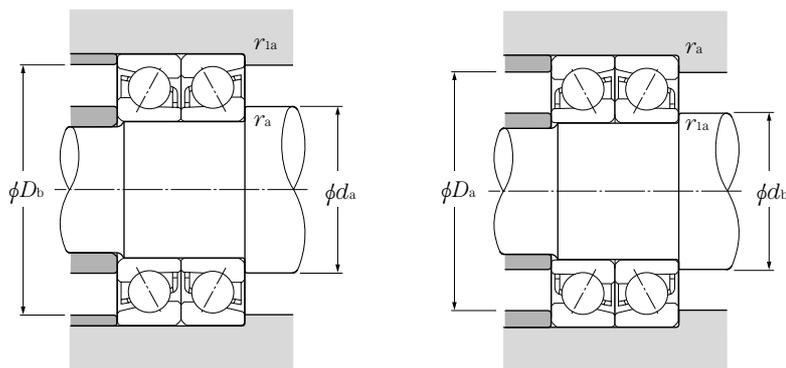

Dynamic equivalent radial load

$$P_r = XF_r + YF_a$$

Contact angle	e	Single, DT				DB, DF			
		$F_a/F_r \leq e$		$F_a/F_r > e$		$F_a/F_r \leq e$		$F_a/F_r > e$	
		X	Y	X	Y	X	Y	X	Y
30°	0.80	1	0	0.39	0.76	1	0.78	0.63	1.24
40°	1.14	1	0	0.35	0.57	1	0.55	0.57	0.93

Static equivalent radial load

$$P_{or} = X_o F_r + Y_o F_a$$

Contact angle	Single, DT		DB, DF	
	X_o	Y_o	X_o	Y_o
30°	0.5	0.33	1	0.66
40°	0.5	0.26	1	0.52

For single and DT arrangement,
When $P_{or} < F_r$ use $P_{or} = F_r$

Basic load ratings				Limiting speeds ¹⁾		Bearing numbers ²⁾			Abutment and fillet dimensions					
dynamic (duplex) kN	static kN	dynamic (duplex) kgf	static kgf	(duplex) min ⁻¹		DB	DF	DT	mm					
C_r	C_{or}	C_r	C_{or}	grease	oil				d_a min	d_b min	D_a max	D_b max	r_{as} max	r_{1as} max
29.3	35.0	2 990	3 550	6 200	8 300	DB	DF	DT	65.5	65.5	79.5	80.5	1	0.6
52.0	56.0	5 300	5 700	5 800	7 700	DB	DF	DT	67	67	88	90.5	1	0.6
100	98.0	10 200	10 000	5 300	7 000	DB	DF	DT	68.5	65.5	101.5	104.5	1.5	1
91.0	89.0	9 250	9 100	4 600	6 100	DB	DF	DT	68.5	65.5	101.5	104.5	1.5	1
159	143	16 200	14 600	4 700	6 300	DB	DF	DT	72	67	118	123	2	1
146	132	14 900	13 400	4 100	5 500	DB	DF	DT	72	67	118	123	2	1
<hr/>														
29.7	36.0	3 050	3 700	5 700	7 600	DB	DF	DT	70.5	70.5	84.5	85.5	1	0.6
55.0	62.5	5 600	6 400	5 400	7 100	DB	DF	DT	72	72	93	95.5	1	0.6
114	116	11 600	11 800	4 900	6 500	DB	DF	DT	73.5	70.5	111.5	114.5	1.5	1
103	105	10 500	10 700	4 200	5 600	DB	DF	DT	73.5	70.5	111.5	114.5	1.5	1
180	164	18 400	16 700	4 400	5 800	DB	DF	DT	77	72	128	133	2	1
166	151	16 900	15 400	3 800	5 100	DB	DF	DT	77	72	128	133	2	1
<hr/>														
42.5	52.5	4 350	5 350	5 300	7 100	DB	DF	DT	75.5	75.5	94.5	95.5	1	0.6
69.5	78.5	7 050	8 050	5 000	6 600	DB	DF	DT	77	77	103	105.5	1	0.6
124	127	12 600	13 000	4 500	6 000	DB	DF	DT	78.5	75.5	116.5	119.5	1.5	1
112	116	11 500	11 800	3 900	5 200	DB	DF	DT	78.5	75.5	116.5	119.5	1.5	1
203	187	20 700	19 100	4 100	5 400	DB	DF	DT	82	77	138	143	2	1
186	172	19 000	17 600	3 500	4 700	DB	DF	DT	82	77	138	143	2	1
<hr/>														
43.0	54.0	4 400	5 500	5 000	6 700	DB	DF	DT	80.5	80.5	99.5	100.5	1	0.6
71.0	83.5	7 250	8 500	4 600	6 200	DB	DF	DT	82	82	108	110.5	1	0.6
128	137	13 100	14 000	4 200	5 600	DB	DF	DT	83.5	80.5	121.5	124.5	1.5	1
116	124	11 800	12 700	3 700	4 900	DB	DF	DT	83.5	80.5	121.5	124.5	1.5	1
221	212	22 500	21 600	3 800	5 000	DB	DF	DT	87	82	148	153	2	1
202	195	20 600	19 800	3 300	4 400	DB	DF	DT	87	82	148	153	2	1
<hr/>														
43.5	56.0	4 450	5 700	4 700	6 200	DB	DF	DT	85.5	85.5	104.5	105.5	1	0.6
86.5	101	8 850	10 300	4 400	5 800	DB	DF	DT	87	87	118	120.5	1	0.6
145	152	14 700	15 500	3 900	5 300	DB	DF	DT	90	85.5	130	134.5	2	1
131	139	13 300	14 100	3 400	4 600	DB	DF	DT	90	85.5	130	134.5	2	1
239	238	24 400	24 200	3 500	4 700	DB	DF	DT	92	87	158	163	2	1
219	218	22 300	22 300	3 100	4 100	DB	DF	DT	92	87	158	163	2	1
<hr/>														
59.0	76.0	6 000	7 750	4 400	5 900	DB	DF	DT	92	92	113	115.5	1	0.6
89.0	107	9 050	10 900	4 100	5 500	DB	DF	DT	92	92	123	125.5	1	0.6
162	177	16 500	18 100	3 700	5 000	DB	DF	DT	95	90.5	140	144.5	2	1
146	161	14 900	16 400	3 200	4 300	DB	DF	DT	95	90.5	140	144.5	2	1

Note: For bearing series 79 and 70, inner rings are constructed with groove abutments on both sides. Therefore, the inner ring chamfer dimension r_1 is identical to dimension r . Furthermore, the radius r_{1a} of the shaft corner roundness is likewise identical to r_a .

Single and Duplex Angular Contact Ball Bearings

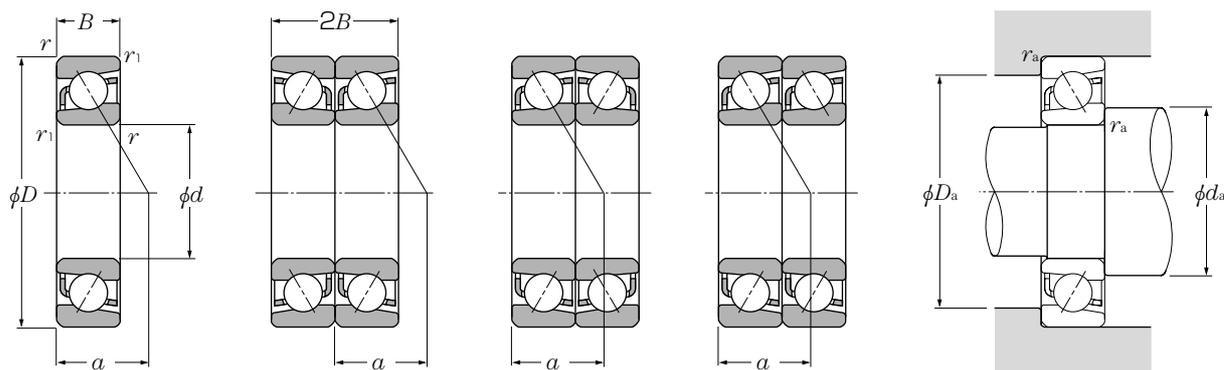

Single

Back-to-back arrangement (DB)

Face-to-face arrangement (DF)

Tandem arrangement (DT)

d 85 ~ 120mm

d	Boundary dimensions					Basic load ratings				Limiting speeds ¹⁾		Bearing ²⁾ numbers	Load center mm a	Mass kg single (approx.)
	D	B	2B	$r_s \text{ min}^{(3)}$	$r_{1s} \text{ min}^{(3)}$	dynamic kN	static C_{or}	dynamic kgf	static C_{or}	grease	oil			
	mm	mm	mm	mm	mm					min ⁻¹	min ⁻¹			
85	180	41	82	3	1.1	159	133	16 200	13 500	4 200	5 600	7317	59	4.34
	180	41	82	3	1.1	146	122	14 800	12 400	3 600	4 800	7317B	76	4.43
90	125	18	36	1.1	0.6	36.0	38.0	3 650	3 850	5 200	7 000	7918	40	0.658
	140	24	48	1.5	1	65.0	63.5	6 650	6 450	4 900	6 500	7018	45	1.35
	160	30	60	2.0	1	118	103	12 000	10 500	4 400	5 900	7218	51	2.18
	160	30	60	2.0	1	107	94.0	10 900	9 550	3 800	5 000	7218B	67.5	2.22
	190	43	86	3.0	1.1	171	147	17 400	15 000	4 000	5 300	7318	62	5.06
190	43	86	3.0	1.1	156	135	15 900	13 800	3 400	4 500	7318B	80.5	5.16	
95	130	18	36	1.1	0.6	37.0	40.5	3 800	4 150	5 000	6 600	7919	41.5	0.688
	145	24	48	1.5	1	67.0	67.0	6 800	6 800	4 600	6 100	7019	46.5	1.41
	170	32	64	2.1	1.1	133	118	13 600	12 000	4 100	5 500	7219	54.5	2.67
	170	32	64	2.1	1.1	121	107	12 300	11 000	3 500	4 700	7219B	71.5	2.72
	200	45	90	3	1.1	183	162	18 600	16 600	3 700	5 000	7319	65	5.89
200	45	90	3	1.1	167	149	17 100	15 200	3 200	4 200	7319B	84.5	6	
100	140	20	40	1.1	0.6	48.0	52.5	4 900	5 350	4 700	6 200	7920	44.5	0.934
	150	24	48	1.5	1	68.5	70.5	6 950	7 200	4 400	5 800	7020	48	1.47
	180	34	68	2.1	1.1	144	126	14 700	12 800	3 900	5 200	7220	57.5	3.2
	180	34	68	2.1	1.1	130	114	13 300	11 700	3 400	4 500	7220B	76	3.26
	215	47	94	3	1.1	207	193	21 100	19 700	3 500	4 700	7320	69	7.18
215	47	94	3	1.1	190	178	19 400	18 100	3 000	4 000	7320B	89.5	7.32	
105	145	20	40	1.1	0.6	48.5	54.5	4 950	5 550	4 400	5 900	7921	46	0.972
	160	26	52	2	1	80.0	81.5	8 150	8 350	4 100	5 500	7021	51.5	1.86
	190	36	72	2.1	1.1	157	142	16 000	14 400	3 700	5 000	7221	60.5	3.79
	190	36	72	2.1	1.1	142	129	14 500	13 100	3 200	4 300	7221B	80	3.87
	225	49	98	3	1.1	220	210	22 400	21 500	3 400	4 500	7321	72	8.2
225	49	98	3	1.1	202	194	20 600	19 700	2 900	3 800	7321B	93.5	8.36	
110	150	20	40	1.1	0.6	49.5	56.0	5 050	5 700	4 200	5 700	7922	47.5	1.01
	170	28	56	2	1	92.0	93.0	9 350	9 450	3 900	5 300	7022	54.5	2.3
	200	38	76	2.1	1.1	170	158	17 300	16 100	3 500	4 700	7222	64	4.45
	200	38	76	2.1	1.1	154	144	15 700	14 700	3 000	4 000	7222B	84	4.54
	240	50	100	3	1.1	246	246	25 100	25 100	3 200	4 300	7322	76	9.6
240	50	100	3	1.1	226	226	23 000	23 100	2 700	3 700	7322B	99	9.8	
120	165	22	44	1.1	0.6	61.0	69.5	6 200	7 100	3 900	5 200	7924	52	1.66

1) This value achieved with machined cages; when pressed cages are used, 80% of this value is acceptable.
 2) Bearing numbers appended with the code "B" have a contact angle of 40°; bearings with this code have a contact angle of 30°.
 3) Smallest allowable dimension for chamfer dimension r or r_1 .

Single and Duplex Angular Contact Ball Bearings

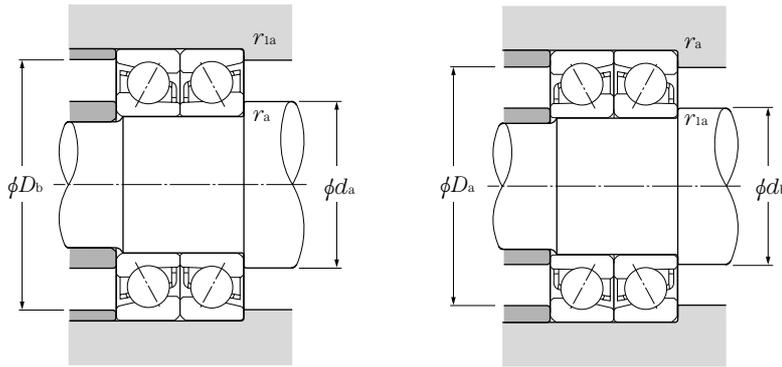

Dynamic equivalent radial load

$$P_r = XF_r + YF_a$$

Contact angle	e	Single, DT				DB, DF			
		$F_a/F_r \leq e$		$F_a/F_r > e$		$F_a/F_r \leq e$		$F_a/F_r > e$	
		X	Y	X	Y	X	Y	X	Y
30°	0.80	1	0	0.39	0.76	1	0.78	0.63	1.24
40°	1.14	1	0	0.35	0.57	1	0.55	0.57	0.93

Static equivalent radial load

$$P_{or} = X_o F_r + Y_o F_a$$

Contact angle	Single, DT		DB, DF	
	X_o	Y_o	X_o	Y_o
30°	0.5	0.33	1	0.66
40°	0.5	0.26	1	0.52

For single and DT arrangement,
When $P_{or} < F_r$ use $P_{or} = F_r$

Basic load ratings				Limiting speeds ¹⁾		Bearing numbers ²⁾			Abutment and fillet dimensions					
dynamic (duplex) kN	static kN	dynamic (duplex) kgf	static kgf	(duplex) min ⁻¹		DB	DF	DT	mm					
C_r	C_{or}	C_r	C_{or}	grease	oil				d_a min	d_b min	D_a max	D_b max	r_{as} max	r_{ias} max
258	265	26 300	27 000	3 300	4 500	DB	DF	DT	99	92	166	173	2.5	1
236	244	24 100	24 900	2 900	3 900	DB	DF	DT	99	92	166	173	2.5	1
58.0	75.5	5 900	7 700	4 200	5 500	DB	DF	DT	97	97	118	120.5	1	0.6
106	127	10 800	12 900	3 900	5 200	DB	DF	DT	98.5	98.5	131.5	134.5	1.5	1
191	206	19 500	21 000	3 500	4 700	DB	DF	DT	100	95.5	150	154.5	2	1
173	188	17 700	19 100	3 100	4 100	DB	DF	DT	100	95.5	150	154.5	2	1
277	294	28 300	30 000	3 200	4 200	DB	DF	DT	104	97	176	183	2.5	1
254	270	25 900	27 600	2 700	3 700	DB	DF	DT	104	97	176	183	2.5	1
60.5	81.5	6 150	8 300	3 900	5 300	DB	DF	DT	102	102	123	125.5	1	0.6
109	134	11 100	13 600	3 700	4 900	DB	DF	DT	103.5	103.5	136.5	139.5	1.5	1
217	236	22 100	24 100	3 300	4 400	DB	DF	DT	107	102	158	163	2	1
196	215	20 000	21 900	2 900	3 800	DB	DF	DT	107	102	158	163	2	1
297	325	30 500	33 000	3 000	3 900	DB	DF	DT	109	102	186	193	2.5	1
272	298	27 700	30 500	2 600	3 400	DB	DF	DT	109	102	186	193	2.5	1
78.0	105	7 950	10 700	3 700	5 000	DB	DF	DT	107	107	133	135.5	1	0.6
111	141	11 300	14 400	3 500	4 600	DB	DF	DT	108.5	108.5	141.5	144.5	1.5	1
233	251	23 800	25 600	3 100	4 200	DB	DF	DT	112	107	168	173	2	1
212	229	21 600	23 300	2 700	3 600	DB	DF	DT	112	107	168	173	2	1
335	385	34 500	39 500	2 800	3 700	DB	DF	DT	114	107	201	208	2.5	1
310	355	31 500	36 000	2 400	3 300	DB	DF	DT	114	107	201	208	2.5	1
79.0	109	8 050	11 100	3 500	4 700	DB	DF	DT	112	112	138	140.5	1	0.6
130	163	13 300	16 700	3 300	4 400	DB	DF	DT	115	115	150	154.5	2	1
254	283	25 900	28 900	3 000	4 000	DB	DF	DT	117	112	178	183	2	1
231	258	23 500	26 300	2 600	3 500	DB	DF	DT	117	112	178	183	2	1
355	420	36 500	43 000	2 700	3 600	DB	DF	DT	119	112	211	218	2.5	1
330	385	33 500	39 500	2 300	3 100	DB	DF	DT	119	112	211	218	2.5	1
80.0	112	8 150	11 400	3 400	4 500	DB	DF	DT	117	117	143	145.5	1	0.6
149	186	15 200	18 900	3 100	4 200	DB	DF	DT	120	120	160	164.5	2	1
276	315	28 100	32 500	2 800	3 800	DB	DF	DT	122	117	188	193	2	1
250	289	25 500	29 400	2 500	3 300	DB	DF	DT	122	117	188	193	2	1
400	490	41 000	50 000	2 600	3 400	DB	DF	DT	124	117	226	233	2.5	1
365	455	37 500	46 000	2 200	3 000	DB	DF	DT	124	117	226	233	2.5	1
99.0	139	10 100	14 200	3 100	4 100	DB	DF	DT	127	127	158	160.5	1	0.6

Note: For bearing series 79 and 70, inner rings are constructed with groove abutments on both sides. Therefore, the inner ring chamfer dimension r_1 is identical to dimension r . Furthermore, the radius r_{1a} of the shaft corner roundness is likewise identical to r_a .

Single and Duplex Angular Contact Ball Bearings

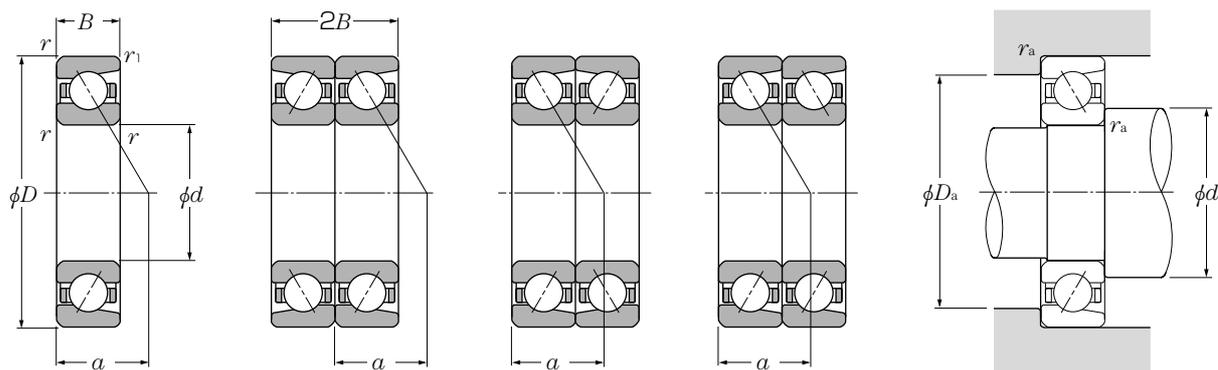

Single

Back-to-back arrangement (DB)

Face-to-face arrangement (DF)

Tandem arrangement (DT)

d 120 ~ 170mm

d	Boundary dimensions					Basic load ratings				Limiting speeds		Bearing ¹⁾ numbers	Load center mm a	Mass kg single (approx.)
	D	B	2B	$r_s \text{ min}^{(2)}$	$r_{1s} \text{ min}^{(2)}$	dynamic kN C_r	static kN C_{or}	dynamic kgf C_r	static kgf C_{or}	grease	oil			
120	180	28	56	2	1	93.5	98.5	9 550	10 000	3 600	4 800	7024	57.5	2.47
	215	40	80	2.1	1.1	183	177	18 600	18 100	3 200	4 300	7224	68.5	6.26
	215	40	80	2.1	1.1	165	162	16 900	16 500	2 800	3 700	7224B	90.5	6.26
	260	55	110	3	1.1	246	252	25 100	25 700	2 900	3 900	7324	82.5	14.7
	260	55	110	3	1.1	225	231	23 000	23 600	2 500	3 300	7324B	107	14.7
130	180	24	48	1.5	1	75.0	87.5	7 650	8 900	3 600	4 700	7926	56.5	1.82
	200	33	66	2	1	117	125	12 000	12 800	3 300	4 400	7026	64	3.73
	230	40	80	3	1.1	196	198	20 000	20 200	3 000	4 000	7226	72	7.15
	230	40	80	3	1.1	177	180	18 100	18 300	2 500	3 400	7226B	95.5	7.15
	280	58	116	4	1.5	273	293	27 900	29 800	2 700	3 600	7326	88	17.6
	280	58	116	4	1.5	250	268	25 500	27 400	2 300	3 100	7326B	115	17.6
140	190	24	48	1.5	1	75.5	90.0	7 700	9 150	3 300	4 400	7928	59.5	1.94
	210	33	66	2	1	120	133	12 200	13 500	3 100	4 100	7028	67	3.96
	250	42	84	3	1.1	203	215	20 700	21 900	2 700	3 600	7228	77.5	8.78
	250	42	84	3	1.1	183	195	18 700	19 900	2 300	3 100	7228B	103	8.78
	300	62	124	4	1.5	300	335	30 500	34 500	2 500	3 300	7328	94.5	21.5
	300	62	124	4	1.5	275	310	28 100	31 500	2 100	2 800	7328B	123	21.5
150	210	28	56	2	1	97.5	117	9 900	11 900	3 100	4 100	7930	66	2.96
	225	35	70	2.1	1.1	137	154	14 000	15 700	2 800	3 800	7030	71.5	4.82
	270	45	90	3	1.1	232	259	23 700	26 400	2 500	3 400	7230	83	11
	270	45	90	3	1.1	210	235	21 400	24 000	2 200	2 900	7230B	111	11
	320	65	130	4	1.5	330	380	33 500	39 000	2 300	3 100	7330	100	25.1
	320	65	130	4	1.5	300	350	30 500	36 000	2 000	2 600	7330B	131	25.1
160	220	28	56	2	1	98.5	121	10 000	12 300	2 800	3 800	7932	69	3.13
	240	38	76	2.1	1.1	155	176	15 800	18 000	2 700	3 600	7032	77	5.96
	290	48	96	3	1.1	263	305	26 800	31 500	2 400	3 200	7232	89	13.7
	290	48	96	3	1.1	238	279	24 200	28 400	2 000	2 700	7232B	118	13.7
	340	68	136	4	1.5	345	420	35 500	43 000	2 100	2 800	7332	106	29.8
	340	68	136	4	1.5	315	385	32 000	39 500	1 800	2 400	7332B	139	29.8
170	230	28	56	2	1	102	129	10 400	13 100	2 700	3 600	7934	71.5	3.29
	260	42	84	2.1	1.1	186	214	18 900	21 900	2 500	3 300	7034	83	7.96
	310	52	104	4	1.5	295	360	30 000	36 500	2 200	3 000	7234	95.5	17
	310	52	104	4	1.5	266	325	27 200	33 000	1 900	2 500	7234B	127	17
	360	72	144	4	1.5	390	485	39 500	49 500	2 000	2 700	7334	113	35.3

1) Bearing numbers appended with the code "B" have a contact angle of 40°; bearings with this code have a contact angle of 30°.
 2) Smallest allowable dimension for chamfer dimension r or r_1 .

Single and Duplex Angular Contact Ball Bearings

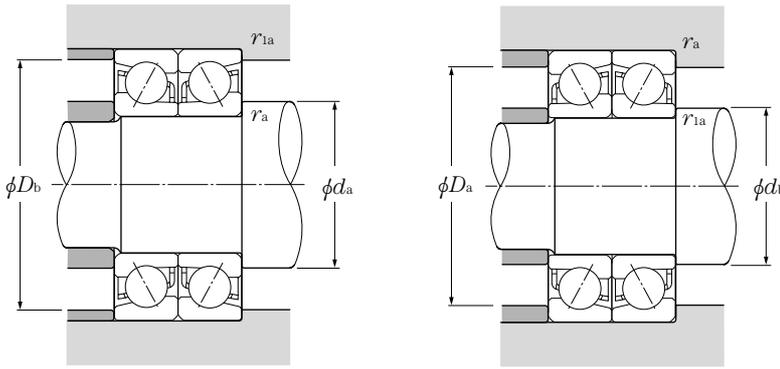

Dynamic equivalent radial load

$$P_r = XF_r + YF_a$$

Contact angle	e	Single, DT				DB, DF			
		$F_a/F_r \leq e$		$F_a/F_r > e$		$F_a/F_r \leq e$		$F_a/F_r > e$	
		X	Y	X	Y	X	Y	X	Y
30°	0.80	1	0	0.39	0.76	1	0.78	0.63	1.24
40°	1.14	1	0	0.35	0.57	1	0.55	0.57	0.93

Static equivalent radial load

$$P_{or} = X_o F_r + Y_o F_a$$

Contact angle	Single, DT		DB, DF	
	X_o	Y_o	X_o	Y_o
30°	0.5	0.33	1	0.66
40°	0.5	0.26	1	0.52

For single and DT arrangement,
When $P_{or} < F_r$ use $P_{or} = F_r$

Basic load ratings				Limiting speeds		Bearing numbers ¹⁾			Abutment and fillet dimensions				
dynamic (duplex) kN	static	dynamic (duplex) kN	static kgf	(duplex) min ⁻¹		DB	DF	DT	mm				
C_r	C_{or}	C_r	C_{or}	grease	oil				d_a min	D_a max	D_b max	r_{as} max	r_{las} max
152	197	15 500	20 100	2 900	3 800	DB	DF	DT	130	170	174.5	2	1
297	355	30 500	36 000	2 600	3 400	DB	DF	DT	132	203	208	2	1
269	325	27 400	33 000	2 300	3 000	DB	DF	DT	132	203	208	2	1
400	505	41 000	51 500	2 300	3 100	DB	DF	DT	134	246	253	2.5	1
365	460	37 500	47 000	2 000	2 700	DB	DF	DT	134	246	253	2.5	1
121	175	12 400	17 800	2 800	3 800	DB	DF	DT	138.5	171.5	174.5	1.5	1
191	251	19 400	25 600	2 600	3 500	DB	DF	DT	140	190	194.5	2	1
320	395	32 500	40 500	2 400	3 100	DB	DF	DT	144	216	223	2.5	1
288	360	29 400	36 500	2 100	2 700	DB	DF	DT	144	216	223	2.5	1
445	585	45 500	59 500	2 100	2 800	DB	DF	DT	148	262	271.5	3	1.5
405	535	41 500	54 500	1 900	2 500	DB	DF	DT	148	262	271.5	3	1.5
123	180	12 500	18 300	2 600	3 500	DB	DF	DT	148.5	181.5	184.5	1.5	1
194	265	19 800	27 000	2 400	3 300	DB	DF	DT	150	200	204.5	2	1
330	430	33 500	44 000	2 200	2 900	DB	DF	DT	154	236	243	2.5	1
297	390	30 500	40 000	1 900	2 500	DB	DF	DT	154	236	243	2.5	1
490	670	50 000	68 500	2 000	2 600	DB	DF	DT	158	282	291.5	3	1.5
445	615	45 500	63 000	1 700	2 300	DB	DF	DT	158	282	291.5	3	1.5
158	234	16 100	23 900	2 400	3 300	DB	DF	DT	160	200	204.5	2	1
222	305	22 700	31 500	2 300	3 000	DB	DF	DT	162	213	218	2	1
375	515	38 500	53 000	2 000	2 700	DB	DF	DT	164	256	263	2.5	1
340	470	34 500	48 000	1 800	2 400	DB	DF	DT	164	256	263	2.5	1
535	765	54 500	78 000	1 800	2 400	DB	DF	DT	168	302	311.5	3	1.5
490	700	50 000	71 500	1 600	2 100	DB	DF	DT	168	302	311.5	3	1.5
160	241	16 300	24 600	2 300	3 000	DB	DF	DT	170	210	214.5	2	1
252	355	25 700	36 000	2 100	2 800	DB	DF	DT	172	228	233	2	1
425	615	43 500	62 500	1 900	2 500	DB	DF	DT	174	276	283	2.5	1
385	555	39 500	57 000	1 600	2 200	DB	DF	DT	174	276	283	2.5	1
565	845	57 500	86 000	1 700	2 300	DB	DF	DT	178	322	331.5	3	1.5
515	770	52 500	79 000	1 500	2 000	DB	DF	DT	178	322	331.5	3	1.5
165	257	16 900	26 200	2 100	2 800	DB	DF	DT	180	220	224.5	2	1
300	430	31 000	43 500	2 000	2 600	DB	DF	DT	182	248	253	2	1
480	715	49 000	73 000	1 800	2 400	DB	DF	DT	188	292	301.5	3	1.5
435	650	44 000	66 500	1 500	2 100	DB	DF	DT	188	292	301.5	3	1.5
630	970	64 500	99 000	1 600	2 100	DB	DF	DT	188	342	351.5	3	1.5

Single and Duplex Angular Contact Ball Bearings

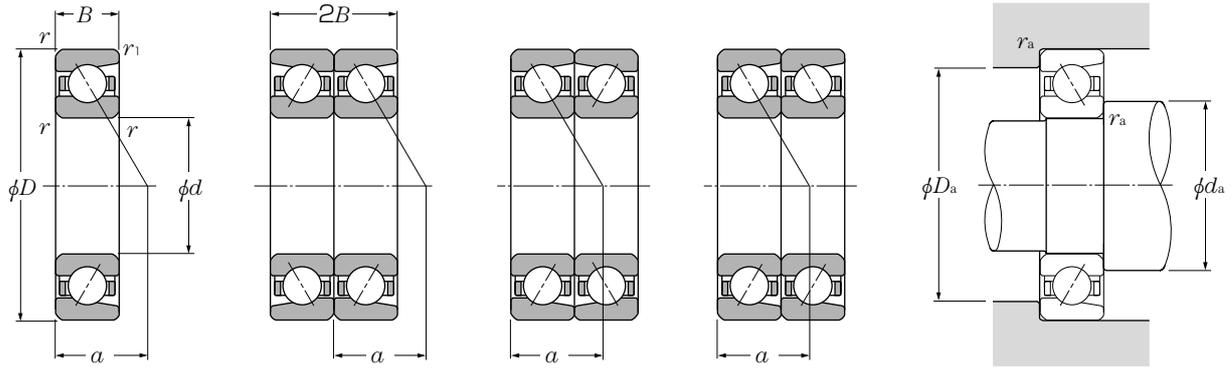

Single

Back-to-back arrangement (DB)

Face-to-face arrangement (DF)

Tandem arrangement (DT)

d 170 ~ 300mm

d	Boundary dimensions					Basic load ratings				Limiting speeds		Bearing ¹⁾ numbers	Load center mm a	Mass kg single (approx.)
	D	B	2B	$r_s \text{ min}^{(2)}$	$r_{1s} \text{ min}^{(2)}$	dynamic kN C_r	static kN C_{or}	dynamic kgf C_r	static kgf C_{or}	grease	oil			
170	360	72	144	4	1.5	355	445	36 000	45 500	1 700	2 300	7334B	147	35.3
180	250	33	66	2	1	131	163	13 400	16 600	2 500	3 300	7936	78.5	4.87
	280	46	92	2.1	1.1	219	266	22 300	27 100	2 300	3 100	7036	89.5	10.4
	320	52	104	4	1.5	305	385	31 000	39 000	2 100	2 800	7236	98	17.7
	320	52	104	4	1.5	276	350	28 100	35 500	1 800	2 400	7236B	131	17.7
	380	75	150	4	1.5	410	535	41 500	54 500	1 900	2 500	7336	118	40.9
380	75	150	4	1.5	375	490	38 000	50 000	1 600	2 100	7336B	155	40.9	
190	260	33	66	2	1	133	169	13 500	17 200	2 400	3 200	7938	81.5	5.1
	290	46	92	2.1	1.1	224	280	22 800	28 600	2 200	2 900	7038	92.5	10.8
	340	55	110	4	1.5	305	390	31 000	39 500	2 000	2 600	7238	104	21.3
	340	55	110	4	1.5	273	355	27 800	36 000	1 700	2 200	7238B	139	21.3
	400	78	156	5	2	430	585	44 000	59 500	1 800	2 300	7338	124	47
400	78	156	5	2	390	535	40 000	54 500	1 500	2 000	7338B	163	47	
200	280	38	76	2.1	1.1	185	231	18 900	23 600	2 200	3 000	7940	88.5	7.15
	310	51	102	2.1	1.1	252	325	25 700	33 000	2 100	2 800	7040	99	14
	360	58	116	4	1.5	335	450	34 500	46 000	1 900	2 500	7240	110	25.3
	360	58	116	4	1.5	305	410	31 000	41 500	1 600	2 100	7240B	146	25.3
	420	80	160	5	2	450	605	46 000	62 000	1 700	2 200	7340	130	53.1
420	80	160	5	2	410	555	42 000	56 500	1 400	1 900	7340B	170	53.1	
220	300	38	76	2.1	1.1	187	239	19 000	24 300	2 000	2 700	7944	94	7.74
240	320	38	76	2.1	1.1	193	255	19 600	26 000	1 800	2 400	7948	100	8.34
260	360	46	92	2.1	1.1	258	375	26 300	38 000	1 700	2 200	7952	112	14
280	380	46	92	2.1	1.1	261	385	26 600	39 500	1 500	2 100	7956	118	14.8
300	420	56	112	3	1.1	325	520	33 500	53 000	1 400	1 900	7960	132	23.7

1) Bearing numbers appended with the code "B" have a contact angle of 40°; bearings with this code have a contact angle of 30°.
 2) Smallest allowable dimension for chamfer dimension r or r1.

Single and Duplex Angular Contact Ball Bearings

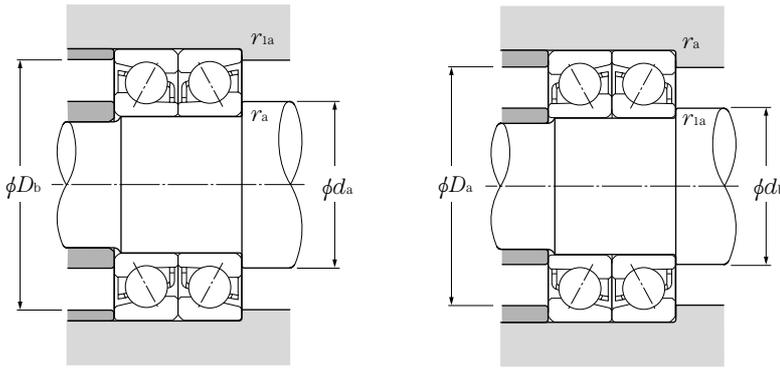

Dynamic equivalent radial load

$$P_r = X F_r + Y F_a$$

Contact angle	e	Single, DT				DB, DF			
		$F_a/F_r \leq e$		$F_a/F_r > e$		$F_a/F_r \leq e$		$F_a/F_r > e$	
		X	Y	X	Y	X	Y	X	Y
30°	0.80	1	0	0.39	0.76	1	0.78	0.63	1.24
40°	1.14	1	0	0.35	0.57	1	0.55	0.57	0.93

Static equivalent radial load

$$P_{or} = X_o F_r + Y_o F_a$$

Contact angle	Single, DT		DB, DF	
	X_o	Y_o	X_o	Y_o
30°	0.5	0.33	1	0.66
40°	0.5	0.26	1	0.52

For single and DT arrangement,
When $P_{or} < F_r$ use $P_{or} = F_r$

Basic load ratings				Limiting speeds		Bearing numbers ¹⁾			Abutment and fillet dimensions				
dynamic (duplex) kN	static	dynamic (duplex) kN	static kgf	(duplex) min ⁻¹		DB	DF	DT	mm				
C_r	C_{or}	C_r	C_{or}	grease	oil				d_a min	D_a max	D_b max	r_{as} max	r_{las} max
575	890	59 000	90 500	1 400	1 800	DB	DF	DT	188	342	351.5	3	1.5
213	325	21 700	33 500	2 000	2 700	DB	DF	DT	190	240	244.5	2	1
355	530	36 500	54 000	1 900	2 500	DB	DF	DT	192	268	273	2	1
495	770	50 500	78 500	1 700	2 200	DB	DF	DT	198	302	311.5	3	1.5
450	700	45 500	71 000	1 400	1 900	DB	DF	DT	198	302	311.5	3	1.5
665	1 070	68 000	109 000	1 500	2 000	DB	DF	DT	198	362	371.5	3	1.5
605	975	62 000	99 500	1 300	1 700	DB	DF	DT	198	362	371.5	3	1.5
216	335	22 000	34 500	1 900	2 500	DB	DF	DT	200	250	254.5	2	1
365	560	37 000	57 000	1 800	2 300	DB	DF	DT	202	278	283	2	1
495	780	50 000	79 500	1 600	2 100	DB	DF	DT	208	322	331.5	3	1.5
445	705	45 000	72 000	1 400	1 800	DB	DF	DT	208	322	331.5	3	1.5
695	1 170	71 000	119 000	1 400	1 900	DB	DF	DT	212	378	390	4	2
635	1 070	64 500	109 000	1 200	1 600	DB	DF	DT	212	378	390	4	2
300	465	30 500	47 000	1 800	2 400	DB	DF	DT	212	268	273	2	1
410	650	41 500	66 000	1 700	2 200	DB	DF	DT	212	298	303	2	1
550	900	56 000	92 000	1 500	2 000	DB	DF	DT	218	342	351.5	3	1.5
495	815	50 500	83 000	1 300	1 700	DB	DF	DT	218	342	351.5	3	1.5
730	1 210	74 500	124 000	1 300	1 800	DB	DF	DT	222	398	410	4	2
665	1 110	68 000	113 000	1 200	1 500	DB	DF	DT	222	398	410	4	2
305	475	31 000	48 500	1 600	2 100	DB	DF	DT	232	288	293	2	1
315	510	32 000	52 000	1 500	1 900	DB	DF	DT	252	308	313	2	1
420	750	42 500	76 500	1 300	1 800	DB	DF	DT	272	348	353	2	1
425	775	43 000	79 000	1 200	1 600	DB	DF	DT	292	368	373	2	1
530	1 040	54 000	106 000	1 100	1 500	DB	DF	DT	314	406	413	2.5	1

Four-Point Contact Ball Bearings

QJ type

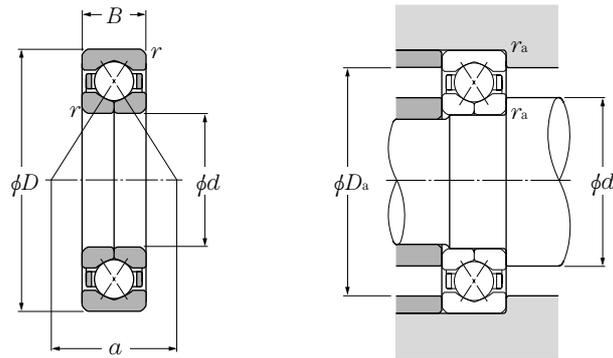

Dynamic equivalent axial load
 $P_a = F_a$
Static equivalent axial load
 $P_{0a} = F_a$

d 30 ~ 90mm

Boundary dimensions	Basic load ratings		Limiting speeds		Bearing numbers	Abutment and fillet dimensions			Load center	Mass
	dynamic	static	dynamic	static		mm	mm	mm		
mm	kN	kgf	min ⁻¹	mm	mm	mm	mm	mm	kg	
d D B $r_{s \min}^{1)}$	C_a C_{0a}	C_a C_{0a}	grease oil	d_a min D_a max r_{as} max	a	(approx.)				
30 72 19 1.1	39.5 57.5	4 050 5 850	8 000 11 000	37 65 1	30	0.42				
35 80 21 1.5	49.5 73.0	5 050 7 450	7 000 9 300	43.5 71.5 1.5	33	0.57				
40 80 18 1.1	44.0 70.5	4 500 7 200	6 900 9 200	47 73 1	34.5	0.45				
	90 23 1.5	60.5 91.5	6 200 9 350	6 200 8 200	48.5 81.5 1.5	37.5 0.78				
45 85 19 1.1	49.5 81.0	5 050 8 250	6 200 8 200	52 78 1	37.5	0.52				
	100 25 1.5	79.0 121	8 050 12 300	5 500 7 400	53.5 91.5 1.5	42 1.05				
50 90 20 1.1	52.0 89.0	5 300 9 050	5 600 7 500	57 83 1	40.5	0.603				
	110 27 2	92.0 145	9 400 14 700	5 000 6 700	60 100 2	46 1.38				
55 100 21 1.5	64.0 112	6 550 11 400	5 100 6 800	63.5 91.5 1.5	44.5	0.78				
	120 29 2	106 170	10 900 17 400	4 600 6 100	65 110 2	50.5 1.76				
60 110 22 1.5	77.5 138	7 900 14 000	4 700 6 300	68.5 101.5 1.5	49	0.98				
	130 31 2.1	122 198	12 400 20 200	4 200 5 700	72 118 2	55 2.18				
65 120 23 1.5	84.5 153	8 600 15 600	4 400 5 800	73.5 111.5 1.5	53.5	1.24				
	140 33 2.1	138 228	14 100 23 200	3 900 5 200	77 128 2	59 2.7				
70 125 24 1.5	92.0 168	9 350 17 200	4 000 5 400	78.5 116.5 1.5	56.5	1.36				
	150 35 2.1	155 260	15 800 26 500	3 600 4 800	82 138 2	63.5 3.27				
75 130 25 1.5	96.0 183	9 750 18 600	3 800 5 000	83.5 121.5 1.5	59	1.53				
	160 37 2.1	169 294	17 200 30 000	3 400 4 500	87 148 2	68 3.9				
80 140 26 2	112 217	11 400 22 100	3 500 4 700	90 130 2	63.5	1.83				
	170 39 2.1	183 330	18 600 33 500	3 200 4 200	92 158 2	72 4.64				
85 150 28 2	126 252	12 800 25 700	3 300 4 400	95 140 2	68	2.3				
	180 41 3	197 370	20 100 37 500	3 000 4 000	99 166 2.5	76.5 5.43				
90 160 30 2	148 293	15 100 29 900	3 100 4 200	100 150 2	72	2.76				
	190 43 3	212 410	21 600 41 500	2 800 3 800	104 176 2.5	81 6.31				

1) Smallest allowable dimension for chamfer dimension r .

Note: 1. These bearings are also manufactured with a slot in the chamfer section of the outer ring to stop whirling.

2. This bearing is widely used in applications where the only type of load is axial. When considering it for use where radial loads are applied, consult NTN Engineering.

● Four-Point Contact Ball Bearings

QJ type

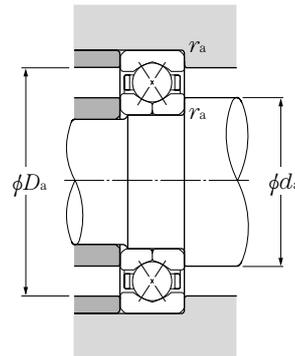
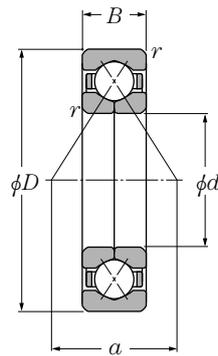

Dynamic equivalent axial load
 $P_a = F_a$
Static equivalent axial load
 $P_{0a} = F_a$

d 95 ~ 120mm

Boundary dimensions	Basic load ratings				Limiting speeds		Bearing numbers	Abutment and fillet dimensions			Load center	Mass			
	mm				min ⁻¹			mm							
d	D	B	r _{s min} ¹⁾	dynamic kN	static kgf	grease	oil	d _{a min}	D _{a max}	r _{as max}	a	(approx.)			
95	170	32	2.1	168	335	17 200	34 000	3 000	3 900	QJ219	107	158	2	76.5	3.35
	200	45	3	227	450	23 100	46 000	2 700	3 500	QJ319	109	186	2.5	85	7.41
100	180	34	2.1	181	355	18 400	36 000	2 800	3 700	QJ220	112	168	2	81	4.02
	215	47	3	273	585	27 800	59 500	2 500	3 400	QJ320	114	201	2.5	91	9.14
105	190	36	2.1	197	400	20 100	41 000	2 700	3 600	QJ221	117	178	2	85	4.75
	225	49	3	273	585	27 900	59 500	2 400	3 200	QJ321	119	211	2.5	95.5	10.4
110	200	38	2.1	213	450	21 700	45 500	2 500	3 400	QJ222	122	188	2	89.5	5.62
	240	50	3	305	680	31 000	69 500	2 300	3 100	QJ322	124	226	2.5	101	12
120	215	40	2.1	240	540	24 500	55 000	2 300	3 100	QJ224	132	203	2	96.5	6.75
	260	55	3	325	765	33 000	78 000	2 100	2 800	QJ324	134	246	2.5	110	15.9

1) Smallest allowable dimension for chamfer dimension r.

Note: 1. These bearings are also manufactured with a slot in the chamfer section of the outer ring to stop whirling.

2. This bearing is widely used in applications where the only type of load is axial. When considering it for use where radial loads are applied, consult NTN Engineering.

Double Row Angular Contact Ball Bearings

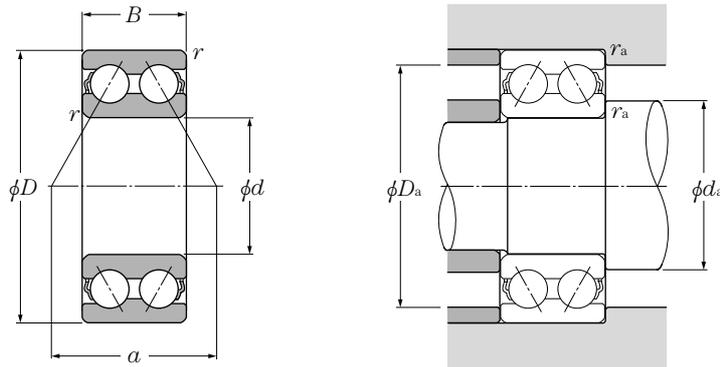

Dynamic equivalent radial load

$$P_r = XF_r + YF_a$$

e	$\frac{F_a}{F_r} \leq e$		$\frac{F_a}{F_r} > e$	
	X	Y	X	Y
0.68	1	0.92	0.67	1.41

Static equivalent radial load

$$P_{or} = F_r + 0.76F_a$$

d 10 ~ 65mm

Boundary dimensions	Basic load ratings		Limiting speeds		Bearing numbers	Abutment and fillet dimensions			Load center	Mass					
	dynamic	static	dynamic	static		mm	mm	mm							
mm	kN	kgf	min ⁻¹	mm	mm	mm	mm	mm	kg						
d	D	B	r _{s min} ¹⁾	C _r	C _{or}	C _r	C _{or}	grease	oil	d _a min	D _a max	r _{as} max	a	(approx.)	
10	30	14.3	0.6	7.15	3.90	730	400	17 000	22 000	5200S	15	25	0.6	14.5	0.05
12	32	15.9	0.6	10.5	5.80	1 070	590	15 000	20 000	5201S	17	27	0.6	16.7	0.06
15	35	15.9	0.6	11.7	7.05	1 190	715	13 000	17 000	5202S	20	30	0.6	18.3	0.07
	42	19	1	17.6	10.2	1 800	1 040	11 000	15 000	5302S	21	36	1	22.0	0.11
17	40	17.5	0.6	14.6	9.05	1 490	920	11 000	15 000	5203S	22	35	0.6	20.8	0.09
	47	22.2	1	21.0	12.6	2 140	1 280	10 000	13 000	5303S	23	41	1	25.0	0.14
20	47	20.6	1	19.6	12.4	2 000	1 270	10 000	13 000	5204S	26	41	1	24.3	0.12
	52	22.2	1.1	24.6	15.0	2 510	1 530	9 000	12 000	5304S	27	45	1	26.7	0.23
25	52	20.6	1	21.3	14.7	2 170	1 500	8 500	11 000	5205S	31	46	1	26.8	0.19
	62	25.4	1.1	32.5	20.7	3 350	2 110	7 500	10 000	5305S	32	55	1	31.8	0.34
30	62	23.8	1	29.6	21.1	3 000	2 150	7 100	9 500	5206S	36	56	1	31.6	0.29
	72	30.2	1.1	40.5	28.1	4 150	2 870	6 300	8 500	5306S	37	65	1	36.5	0.51
35	72	27	1.1	39.0	28.7	4 000	2 920	6 300	8 000	5207S	42	65	1	36.6	0.43
	80	34.9	1.5	51.0	36.0	5 200	3 700	5 600	7 500	5307S	44	71	1.5	41.6	0.79
40	80	30.2	1.1	44.0	33.5	4 500	3 400	5 600	7 100	5208S	47	73	1	41.5	0.57
	90	36.5	1.5	56.5	41.0	5 800	4 200	5 300	6 700	5308S	49	81	1.5	45.5	1.05
45	85	30.2	1.1	49.5	38.0	5 050	3 900	5 000	6 700	5209S	52	78	1	43.4	0.62
	100	39.7	1.5	68.5	51.0	7 000	5 200	4 500	6 000	5309S	54	91	1.5	50.6	1.40
50	90	30.2	1.1	53.0	43.5	5 400	4 400	4 800	6 000	5210S	57	83	1	45.9	0.67
	110	44.4	2	81.5	61.5	8 300	6 250	4 300	5 600	5310S	60	100	2	55.6	1.95
55	100	33.3	1.5	56.0	49.0	5 700	5 000	4 300	5 600	5211S	64	91	1.5	50.1	0.96
	120	49.2	2	95.0	73.0	9 700	7 450	3 800	5 000	5311S	65	110	2	60.6	2.30
60	110	36.5	1.5	69.0	62.0	7 150	6 300	3 800	5 000	5212S	69	101	1.5	56.5	1.35
	130	54	2.1	125	98.5	12 800	10 000	3 400	4 500	5312S	72	118	2	69.2	3.15
65	120	38.1	1.5	76.5	69.0	7 800	7 050	3 600	4 500	5213S	74	111	1.5	59.7	1.65
	140	58.7	2.1	142	113	14 500	11 500	3 200	4 300	5313S	77	128	2	72.8	3.85

1) Smallest allowable dimension for chamfer dimension r.

● Double Row Angular Contact Ball Bearings

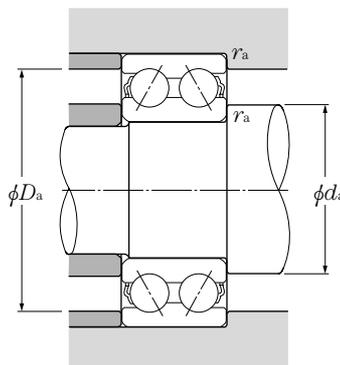
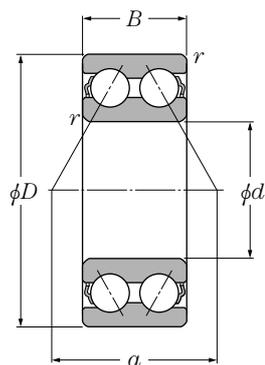

Dynamic equivalent radial load

$$P_r = X F_r + Y F_a$$

e	$\frac{F_a}{F_r} \leq e$		$\frac{F_a}{F_r} > e$	
	X	Y	X	Y
0.68	1	0.92	0.67	1.41

Static equivalent radial load

$$P_{or} = F_r + 0.76 F_a$$

d 70 ~ 85mm

d	Boundary dimensions			Basic load ratings				Limiting speeds		Bearing numbers	Abutment and fillet dimensions			Load center	Mass
	mm			dynamic	static	dynamic	static	min ⁻¹			mm				
	D	B	r _{s min} ¹⁾	kN	C _{or}	kgf	C _{or}	grease	oil		d _{a min}	D _{a max}	r _{as max}		
70	125	39.7	1.5	94.0	82.0	9 600	8 400	3 400	4 500	5214S	79	116	1.5	63.8	1.80
	150	63.5	2.1	159	128	16 200	13 100	3 000	3 800	5314S	82	138	2	78.3	4.90
75	130	41.3	1.5	93.5	83.0	9 550	8 500	3 200	4 300	5215S	84	121	1.5	66.1	1.90
80	140	44.4	2	99.0	93.0	10 100	9 500	3 000	3 800	5216S	90	130	2	69.6	2.50
85	150	49.2	2	116	110	11 800	11 200	2 800	3 600	5217S	95	140	2	75.3	3.40

1) Smallest allowable dimension for chamfer dimension r.

Double Row Angular Contact Ball Bearings

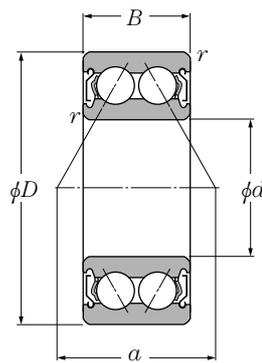

Shielded type (ZZ)

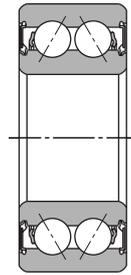

Non-contact sealed type (LLM)

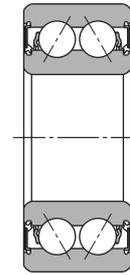

Contact sealed type (LLD)

d 10 ~ 40mm

d	Boundary dimensions			Basic load ratings				Limiting speeds			Bearing numbers ²⁾		
	mm			dynamic	static	dynamic	static	min ⁻¹		oil Z,LM	sealed	non-contact type	contact type
	D	B	r _{s min} ¹⁾	C _r	C _{or}	C _r	C _{or}	grease ZZ,LLM	LLD				
10	30	14.3	0.6	7.15	3.90	730	400	17 000	15 000	22 000	5200SCZZ	LLM	LLD
12	32	15.9	0.6	8.50	5.30	865	540	15 000	12 000	20 000	5201SCZZ	LLM	LLD
15	35	15.9	0.6	8.50	5.30	865	540	13 000	12 000	17 000	5202SCZZ	LLM	LLD
17	40	17.5	0.6	12.7	8.30	1 290	850	11 000	10 000	15 000	5203SCZZ	LLM	LLD
	47	22.2	1	19.6	12.4	2 000	1 270	10 000	9 500	13 000	5303SCZZ	LLM	LLD
20	47	20.6	1	15.9	10.7	1 620	1 090	10 000	9 000	13 000	5204SCZZ	LLM	LLD
25	52	20.6	1	16.9	12.3	1 730	1 260	8 500	7 500	11 000	5205SCZZ ³⁾	LLM	LLD
	62	25.4	1.1	25.2	18.2	2 570	1 850	7 500	6 300	10 000	5305SCZZ	LLM	LLD
30	62	23.8	1	25.2	18.2	2 570	1 850	7 100	6 300	9 500	5206SCZZ	LLM	LLD
	72	30.2	1.1	39.0	28.7	4 000	2 920	6 300	5 300	8 500	5306SCZZ	LLM	LLD
35	72	27.0	1.1	34.0	25.3	3 500	2 580	6 300	5 300	8 500	5207SCZZ	LLM	LLD
	80	34.9	1.5	44.0	33.5	4 500	3 400	5 600	4 800	7 500	5307SCZZ	LLM	LLD
40	80	30.2	1.1	36.5	29.0	3 700	2 960	5 600	4 800	7 100	5208SCZZ ³⁾	LLM	LLD
	90	36.5	1.5	49.5	38.0	5 050	3 900	5 300	4 500	6 700	5308SCZZ	LLM	LLD

1) Smallest allowable dimension for chamfer dimension r.

2) This bearing number is for double sealed and double shielded type bearings, but single sealed and single shielded type are also available.

3) Resin formed cage is standard for 5205SC and 5208SC.

● Double Row Angular Contact Ball Bearings

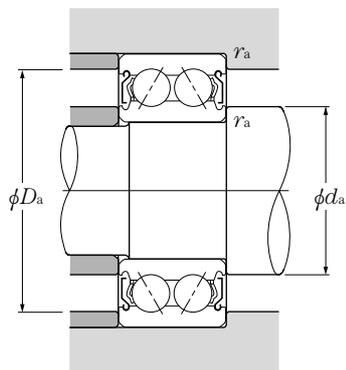

Dynamic equivalent radial load

$$P_r = X F_r + Y F_a$$

e	$\frac{F_a}{F_r} \leq e$		$\frac{F_a}{F_r} > e$	
	X	Y	X	Y
0.68	1	0.92	0.67	1.41

Static equivalent radial load

$$P_{or} = F_r + 0.76 F_a$$

Abutment and fillet dimensions				Load center mm
mm				
d_a min	d_a max	D_a max	r_{as} max	a
14	15.5	26	0.6	14.5
16	19.0	28	0.6	16.3
19	19.0	31	0.6	16.3
21	23.5	36	0.6	20.1
23	25.5	41	1	24.3
26	26.5	41	1	23.0
31	32.0	46	1	25.4
32	38.5	55	1	30.9
36	38.5	56	1	30.9
37	44.5	65	1	36.6
42	45.0	65	1	36.3
44	50.5	71	1.5	41.5
47	50.5	73	1	39.4
49	53.0	81	1.5	43.0





چرخ صنعت کشور



1. Design features and characteristics

The outer ring raceway of self-aligning ball bearings forms a spherical surface whose center is common to the bearing center. The inner ring of the bearing has two raceways. The balls, cage, and inner ring of these bearings are capable of a shifting in order to compensate for a certain degree of misalignment with the outer rings. As a result, the bearing is able to align itself and compensate for shaft / housing finishing unevenness, bearing fitting error, and other sources of misalignment as shown in **Diagram 1**.

However, since axial load capacity is limited, self-aligning ball bearings are not suitable for applications with heavy axial loads.

Furthermore, if an adapter is used on the tapered bore of the inner diameter, installation and disassembly are much simpler and for this reason adapters are often used on equipment with drive shafts.

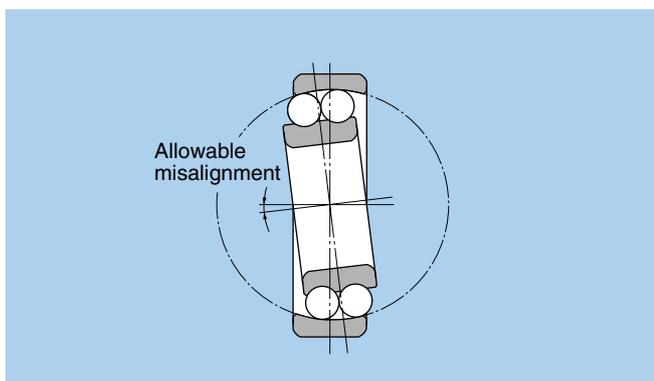

Diagram 1.

2. Standard cage types

All bearing series are equipped with a pressed cage, except 2322S, which is equipped with a machined cage.

3. Ball protrusion

Bearings with part numbers listed in **Diagram 2** below have balls which protrude slightly from the bearing face.

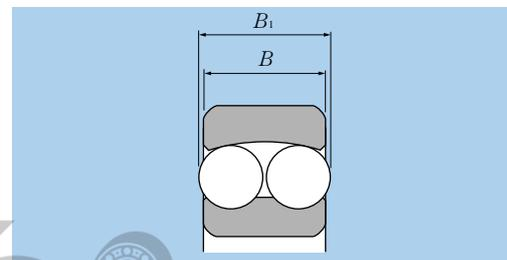

Diagram 2.

their degree of protrusion is listed below

Units mm

Bearing number	Width dimension B	Total width dimension B_1
2222S (K)	53	54
2316S (K)	58	59
2319S (K)	67	68
2320S (K)	73	74
2321S	77	78
2322S (K)	80	81
1318S (K)	43	46
1319S (K)	45	49
1320S (K)	47	53
1321S	49	55
1322S (K)	50	56

4. Allowable misalignment angle

Listed below are the allowable misalignment angles for bearings with self-aligning characteristics when placed under normal load conditions. This degree of allowable misalignment may be limited by the design of structures around the bearing.

Allowable misalignment under normal loads (loads equivalent to $0.09 C_r$): $0.07 \text{ rad } (4^\circ)$

Self-Aligning Ball Bearings

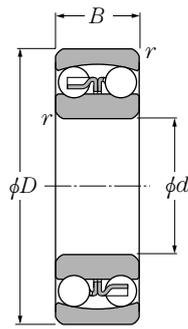

Cylindrical bore

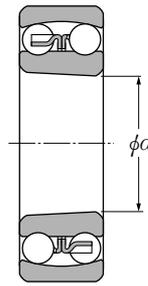

Tapered bore

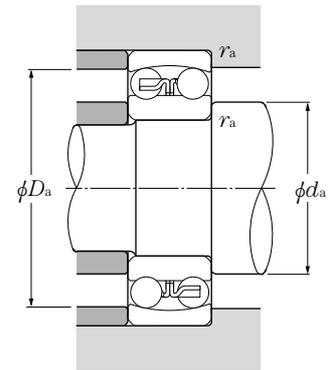

d 10 ~ 35mm

	Boundary dimensions				Basic load ratings				Limiting speeds		Bearing numbers		Abutment and fillet dimensions		
	mm				dynamic kN	static kN	dynamic kgf	static kgf	min ⁻¹		cylindrical bore	tapered ²⁾ bore	<i>d</i> _a min	<i>D</i> _a max	<i>r</i> _{as} max
<i>d</i>	<i>D</i>	<i>B</i>	<i>r</i> _{s min¹⁾}	<i>C</i> _r	<i>C</i> _{or}	<i>C</i> _r	<i>C</i> _{or}	grease	oil						
10	30	9	0.6	5.55	1.19	570	121	22 000	28 000	1200S	—	14.0	26.0	0.6	
	30	14	0.6	7.45	1.59	760	162	24 000	28 000	2200S	—	14.0	26.0	0.6	
	35	11	0.6	7.35	1.62	750	165	20 000	24 000	1300S	—	14.0	31.0	0.6	
	35	17	0.6	9.20	2.01	935	205	18 000	22 000	2300S	—	14.0	31.0	0.6	
12	32	10	0.6	5.70	1.27	580	130	22 000	26 000	1201S	—	16.0	28.0	0.6	
	32	14	0.6	7.75	1.73	790	177	22 000	26 000	2201S	—	16.0	28.0	0.6	
	37	12	1	9.65	2.16	985	221	18 000	22 000	1301S	—	17.0	32.0	1	
	37	17	1	12.1	2.73	1 240	278	17 000	22 000	2301S	—	17.0	32.0	1	
15	35	11	0.6	7.60	1.75	775	179	18 000	22 000	1202S	—	19.0	31.0	0.6	
	35	14	0.6	7.80	1.85	795	188	18 000	22 000	2202S	—	19.0	31.0	0.6	
	42	13	1	9.70	2.29	990	234	16 000	20 000	1302S	—	20.0	37.0	1	
	42	17	1	12.3	2.91	1 250	296	14 000	18 000	2302S	—	20.0	37.0	1	
17	40	12	0.6	8.00	2.01	815	205	16 000	20 000	1203S	—	21.0	36.0	0.6	
	40	16	0.6	9.95	2.42	1 010	247	16 000	20 000	2203S	—	21.0	36.0	0.6	
	47	14	1	12.7	3.20	1 300	325	14 000	17 000	1303S	—	22.0	42.0	1	
	47	19	1	14.7	3.55	1 500	365	13 000	16 000	2303S	—	22.0	42.0	1	
20	47	14	1	10.0	2.61	1 020	266	14 000	17 000	1204S	1204SK	25.0	42.0	1	
	47	18	1	12.8	3.30	1 310	340	14 000	17 000	2204S	2204SK	25.0	42.0	1	
	52	15	1.1	12.6	3.35	1 280	340	12 000	15 000	1304S	1304SK	26.5	45.5	1	
	52	21	1.1	18.5	4.70	1 880	480	11 000	14 000	2304S	2304SK	26.5	45.5	1	
25	52	15	1	12.2	3.30	1 250	335	12 000	14 000	1205S	1205SK	30.0	47.0	1	
	52	18	1	12.4	3.45	1 270	350	12 000	14 000	2205S	2205SK	30.0	47.0	1	
	62	17	1.1	18.2	5.00	1 850	510	10 000	13 000	1305S	1305SK	31.5	55.5	1	
	62	24	1.1	24.9	6.60	2 530	675	9 500	12 000	2305S	2305SK	31.5	55.5	1	
30	62	16	1	15.8	4.65	1 610	475	10 000	12 000	1206S	1206SK	35.0	57.0	1	
	62	20	1	15.3	4.55	1 560	460	10 000	12 000	2206S	2206SK	35.0	57.0	1	
	72	19	1.1	21.4	6.30	2 190	645	8 500	11 000	1306S	1306SK	36.5	65.5	1	
	72	27	1.1	32.0	8.75	3 250	895	8 000	10 000	2306S	2306SK	36.5	65.5	1	
35	72	17	1.1	15.9	5.10	1 620	520	8 500	10 000	1207S	1207SK	41.5	65.5	1	
	72	23	1.1	21.7	6.60	2 210	675	8 500	10 000	2207S	2207SK	41.5	65.5	1	
	80	21	1.5	25.3	7.85	2 580	800	7 500	9 500	1307S	1307SK	43.0	72.0	1.5	
	80	31	1.5	40.0	11.3	4 100	1 150	7 100	9 000	2307S	2307SK	43.0	72.0	1.5	

1) Smallest allowable dimension for chamfer dimension *r*. 2) "K" indicates bearings have tapered bore with a taper ratio of 1: 12.

Equivalent bearing load
dynamic

$$P_r = XF_r + YF_a$$

$\frac{F_a}{F_r} \leq e$		$\frac{F_a}{F_r} > e$	
X	Y	X	Y
1	Y ₁	0.65	Y ₂

static

$$P_{or} = F_r + Y_o F_a$$

For values of *e*, Y₁, Y₂ and Y_o see the table below.

Constant	Axial load factors			Mass
<i>e</i>	Y ₁	Y ₂	Y _o	kg
				(approx.)
0.32	2.00	3.10	2.10	0.033
0.64	0.98	1.50	1.00	0.042
0.35	1.80	2.80	1.90	0.057
0.71	0.89	1.40	0.93	0.077
0.36	1.80	2.70	1.80	0.039
0.58	1.10	1.70	1.10	0.048
0.33	1.90	2.90	2.00	0.066
0.60	1.10	1.60	1.10	0.082
0.32	2.00	3.10	2.10	0.051
0.50	1.30	1.90	1.30	0.055
0.33	1.90	2.90	2.00	0.093
0.51	1.20	1.90	1.30	0.108
0.31	2.00	3.10	2.10	0.072
0.50	1.30	1.90	1.30	0.085
0.32	2.00	3.10	2.10	0.130
0.51	1.20	1.90	1.30	0.150
0.29	2.20	3.40	2.30	0.120
0.47	1.30	2.10	1.40	0.133
0.29	2.20	3.40	2.30	0.15
0.50	1.20	1.90	1.30	0.193
0.28	2.30	3.50	2.40	0.140
0.41	1.50	2.40	1.60	0.150
0.28	2.30	3.50	2.40	0.255
0.47	1.40	2.10	1.40	0.319
0.25	2.50	3.90	2.60	0.220
0.38	1.60	2.50	1.70	0.249
0.26	2.40	3.70	2.50	0.385
0.44	1.40	2.20	1.50	0.480
0.23	2.70	4.20	2.80	0.320
0.37	1.70	2.60	1.80	0.378
0.26	2.50	3.80	2.60	0.510
0.46	1.40	2.10	1.40	0.642

Self-Aligning Ball Bearings

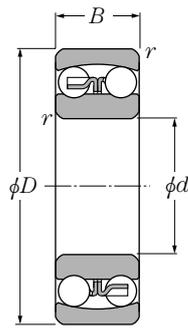

Cylindrical bore

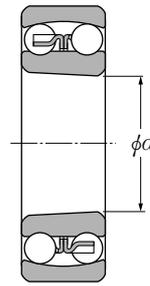

Tapered bore

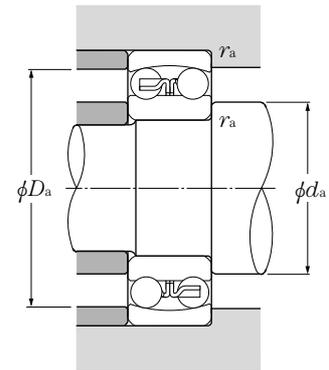

d 40 ~ 75mm

d	Boundary dimensions			Basic load ratings				Limiting speeds		Bearing numbers		Abutment and fillet dimensions		
	D	B	$r_{s \min}^{1)}$	dynamic kN	static kN	dynamic kgf	static kgf	grease	oil	cylindrical bore	tapered ²⁾ bore	d_a min	D_a max	r_{as} max
40	80	18	1.1	19.3	6.50	1 970	665	7 500	9 000	1208S	1208SK	46.5	73.5	1
	80	23	1.1	22.4	7.35	2 290	750	7 500	9 000	2208S	2208SK	46.5	73.5	1
	90	23	1.5	29.8	9.70	3 050	990	6 700	8 500	1308S	1308SK	48.0	82.0	1.5
	90	33	1.5	45.5	13.5	4 650	1 380	6 300	8 000	2308S	2308SK	48.0	82.0	1.5
45	85	19	1.1	22.0	7.35	2 240	750	7 100	8 500	1209S	1209SK	51.5	78.5	1
	85	23	1.1	23.3	8.15	2 380	830	7 100	8 500	2209S	2209SK	51.5	78.5	1
	100	25	1.5	38.5	12.7	3 900	1 300	6 000	7 500	1309S	1309SK	53.0	92.0	1.5
	100	36	1.5	55.0	16.7	5 600	1 700	5 600	7 100	2309S	2309SK	53.0	92.0	1.5
50	90	20	1.1	22.8	8.10	2 330	830	6 300	8 000	1210S	1210SK	56.5	83.5	1
	90	23	1.1	23.3	8.45	2 380	865	6 300	8 000	2210S	2210SK	56.5	83.5	1
	110	27	2	43.5	14.1	4 450	1 440	5 600	6 700	1310S	1310SK	59.0	101	2
	110	40	2	65.0	20.2	6 650	2 060	5 000	6 300	2310S	2310SK	59.0	101	2
55	100	21	1.5	26.9	10.0	2 750	1 020	6 000	7 100	1211S	1211SK	63.0	92.0	1.5
	100	25	1.5	26.7	9.90	2 720	1 010	6 000	7 100	2211S	2211SK	63.0	92.0	1.5
	120	29	2	51.5	17.9	5 250	1 820	5 000	6 300	1311S	1311SK	64.0	111	2
	120	43	2	76.5	24.0	7 800	2 450	4 800	6 000	2311S	2311SK	64.0	111	2
60	110	22	1.5	30.5	11.5	3 100	1 180	5 300	6 300	1212S	1212SK	68.0	102	1.5
	110	28	1.5	34.0	12.6	3 500	1 290	5 300	6 300	2212S	2212SK	68.0	102	1.5
	130	31	2.1	57.5	20.8	5 900	2 130	4 500	5 600	1312S	1312SK	71.0	119	2
	130	46	2.1	88.5	28.3	9 000	2 880	4 300	5 300	2312S	2312SK	71.0	119	2
65	120	23	1.5	31.0	12.5	3 150	1 280	4 800	6 000	1213S	1213SK	73.0	112	1.5
	120	31	1.5	43.5	16.4	4 450	1 670	4 800	6 000	2213S	2213SK	73.0	112	1.5
	140	33	2.1	62.5	22.9	6 350	2 330	4 300	5 300	1313S	1313SK	76.0	129	2
	140	48	2.1	97.0	32.5	9 900	3 300	3 800	4 800	2313S	2313SK	76.0	129	2
70	125	24	1.5	35.0	13.8	3 550	1 410	4 800	5 600	1214S	—	78.0	117	1.5
	125	31	1.5	44.0	17.1	4 500	1 740	4 500	5 600	2214S	—	78.0	117	1.5
	150	35	2.1	75.0	27.7	7 650	2 830	4 000	5 000	1314S	—	81.0	139	2
	150	51	2.1	111	37.5	11 300	3 850	3 600	4 500	2314S	—	81.0	139	2
75	130	25	1.5	39.0	15.7	4 000	1 600	4 300	5 300	1215S	1215SK	83.0	122	1.5
	130	31	1.5	44.5	17.8	4 550	1 820	4 300	5 300	2215S	2215SK	83.0	122	1.5
	160	37	2.1	80.0	30.0	8 150	3 050	3 800	4 500	1315S	1315SK	86.0	149	2
	160	55	2.1	125	43.0	12 700	4 400	3 400	4 300	2315S	2315SK	86.0	149	2

1) Smallest allowable dimension for chamfer dimension r. 2) "K" indicates bearings have tapered bore with a taper ratio of 1: 12.

Equivalent bearing load
dynamic

$$P_r = XF_r + YF_a$$

$\frac{F_a}{F_r} \leq e$		$\frac{F_a}{F_r} > e$	
X	Y	X	Y
1	Y ₁	0.65	Y ₂

static

$$P_{0r} = F_r + Y_0 F_a$$

For values of *e*, Y₁, Y₂ and Y₀ see the table below.

Constant	Axial load factors			Mass
<i>e</i>	Y ₁	Y ₂	Y ₀	kg
				(approx.)
0.22	2.8	4.3	2.9	0.415
0.33	1.9	3.0	2.0	0.477
0.24	2.6	4.0	2.7	0.715
0.43	1.5	2.3	1.5	0.889
0.21	3.0	4.7	3.1	0.465
0.30	2.1	3.2	2.2	0.522
0.25	2.6	4.0	2.7	0.955
0.41	1.5	2.4	1.6	1.200
0.21	3.1	4.7	3.2	0.525
0.28	2.2	3.4	2.3	0.564
0.23	2.7	4.2	2.8	1.250
0.42	1.5	2.3	1.6	1.580
0.20	3.2	4.9	3.3	0.705
0.28	2.3	3.5	2.4	0.746
0.23	2.7	4.2	2.8	1.600
0.41	1.5	2.4	1.6	2.030
0.18	3.4	5.3	3.6	0.900
0.28	2.3	3.5	2.4	1.030
0.23	2.8	4.3	2.9	2.030
0.40	1.6	2.4	1.6	2.570
0.17	3.7	5.7	3.8	1.150
0.28	2.3	3.5	2.4	1.400
0.23	2.7	4.2	2.9	2.540
0.39	1.6	2.5	1.7	3.200
0.18	3.4	5.3	3.6	1.300
0.26	2.4	3.7	2.5	1.520
0.22	2.8	4.4	3.0	3.190
0.38	1.7	2.6	1.8	3.900
0.17	3.6	5.6	3.8	1.410
0.25	2.5	3.9	2.6	1.600
0.22	2.8	4.4	2.9	3.650
0.38	1.6	2.5	1.7	4.770



Self-Aligning Ball Bearings

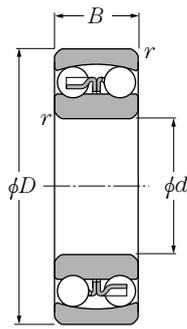

Cylindrical bore

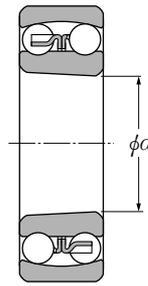

Tapered bore

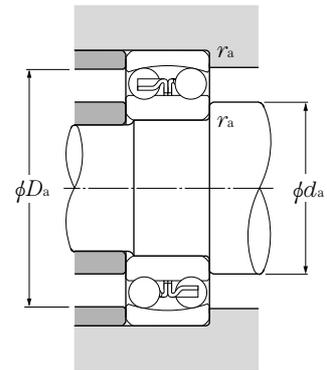

d 80 ~ 110mm

d	Boundary dimensions			Basic load ratings				Limiting speeds		Bearing numbers		Abutment and fillet dimensions		
	D	B	$r_{s \min}^{1)}$	dynamic kN	static kN	dynamic kgf	static kgf	grease	oil	cylindrical bore	tapered ²⁾ bore	d_a min	D_a max	r_{as} max
80	140	26	2	40.0	17.0	4 100	1 730	4 000	5 000	1216S	1216SK	89	131	2
	140	33	2	49.0	19.9	5 000	2 030	4 000	5 000	2216S	2216SK	89	131	2
	170	39	2.1	89.0	33.0	9 100	3 400	3 600	4 300	1316S	1316SK	91	159	2
	170	58	2.1	130	45.0	13 200	4 600	3 200	4 000	2316S	2316SK	91	159	2
85	150	28	2	49.5	20.8	5 050	2 120	3 800	4 500	1217S	1217SK	94	141	2
	150	36	2	58.5	23.6	5 950	2 400	3 800	4 800	2217S	2217SK	94	141	2
	180	41	3	98.5	38.0	10 000	3 850	3 400	4 000	1317S	1317SK	98	167	2.5
	180	60	3	142	51.5	14 500	5 250	3 000	3 800	2317S	2317SK	98	167	2.5
90	160	30	2	57.5	23.5	5 850	2 400	3 600	4 300	1218S	1218SK	99	151	2
	160	40	2	70.5	28.7	7 200	2 930	3 600	4 300	2218S	2218SK	99	151	2
	190	43	3	117	44.5	12 000	4 550	3 200	3 800	1318S	1318SK	103	177	2.5
	190	64	3	154	57.5	15 700	5 850	2 800	3 600	2318S	2318SK	103	177	2.5
95	170	32	2.1	64.0	27.1	6 550	2 770	3 400	4 000	1219S	1219SK	106	159	2
	170	43	2.1	84.0	34.5	8 550	3 500	3 400	4 000	2219S	2219SK	106	159	2
	200	45	3	129	51.0	13 200	5 200	3 000	3 600	1319S	1319SK	108	187	2.5
	200	67	3	161	64.5	16 400	6 550	2 800	3 400	2319S	2319SK	108	187	2.5
100	180	34	2.1	69.5	29.7	7 100	3 050	3 200	3 800	1220S	1220SK	111	169	2
	180	46	2.1	94.5	38.5	9 650	3 900	3 200	3 800	2220S	2220SK	111	169	2
	215	47	3	140	57.5	14 300	5 850	2 800	3 400	1320S	1320SK	113	202	2.5
	215	73	3	187	79.0	19 100	8 050	2 400	3 200	2320S	2320SK	113	202	2.5
105	190	36	2.1	75.0	32.5	7 650	3 300	3 000	3 600	1221S	—	116	179	2
	190	50	2.1	109	45.0	11 100	4 550	3 000	3 600	2221S	—	116	179	2
	225	49	3	154	64.5	15 700	6 600	2 600	3 200	1321S	—	118	212	2.5
	225	77	3	200	87.0	20 400	8 850	2 400	3 000	2321S	—	118	212	2.5
110	200	38	2.1	87.0	38.5	8 900	3 950	2 800	3 400	1222S	1222SK	121	189	2
	200	53	2.1	122	51.5	12 500	5 250	2 800	3 400	2222S	2222SK	121	189	2
	240	50	3	161	72.5	16 400	7 300	2 400	3 000	1322S	1322SK	123	227	2.5
	240	80	3	211	94.5	21 600	9 650	2 200	2 800	2322S ³⁾	2322SK	123	227	2.5

1) Smallest allowable dimension for chamfer dimension r . 2) "K" indicates bearings have tapered bore with a taper ratio of 1: 12.

3) Machined cage is standard for 2322S (K).

Equivalent bearing load dynamic

$$P_r = XF_r + YF_a$$

$\frac{F_a}{F_r} \leq e$		$\frac{F_a}{F_r} > e$	
X	Y	X	Y
1	Y_1	0.65	Y_2

static

$$P_{0r} = F_r + Y_0 F_a$$

For values of e , Y_1 , Y_2 and Y_0 see the table below.

Constant e	Axial load factors			Mass kg (approx.)
	Y_1	Y_2	Y_0	
0.16	3.9	6.0	4.1	1.73
0.25	2.5	3.9	2.7	1.97
0.22	2.9	4.5	3.1	4.31
0.39	1.6	2.5	1.7	5.54
<hr/>				
0.17	3.7	5.7	3.8	2.09
0.25	2.5	3.9	2.6	2.48
0.21	2.9	4.6	3.1	5.13
0.37	1.7	2.6	1.8	6.56
<hr/>				
0.17	3.8	5.8	3.9	2.55
0.27	2.4	3.7	2.5	3.13
0.22	2.8	4.3	2.9	5.94
0.38	1.7	2.6	1.7	7.76
<hr/>				
0.17	3.7	5.8	3.9	3.21
0.27	2.4	3.7	2.5	3.87
0.23	2.8	4.3	2.9	6.84
0.38	1.7	2.6	1.8	9.01
<hr/>				
0.17	3.6	5.6	3.8	3.82
0.27	2.4	3.7	2.5	4.53
0.24	2.7	4.1	2.8	8.46
0.38	1.7	2.6	1.8	11.6
<hr/>				
0.18	3.6	5.5	3.7	4.52
0.28	2.3	3.5	2.4	5.64
0.23	2.7	4.2	2.9	10.0
0.38	1.7	2.6	1.7	14.4
<hr/>				
0.18	3.7	5.7	3.9	5.33
0.28	2.2	3.5	2.3	6.64
0.22	2.8	4.4	3.0	12.0
0.37	1.7	2.6	1.8	17.4



(for self-aligning ball bearings)

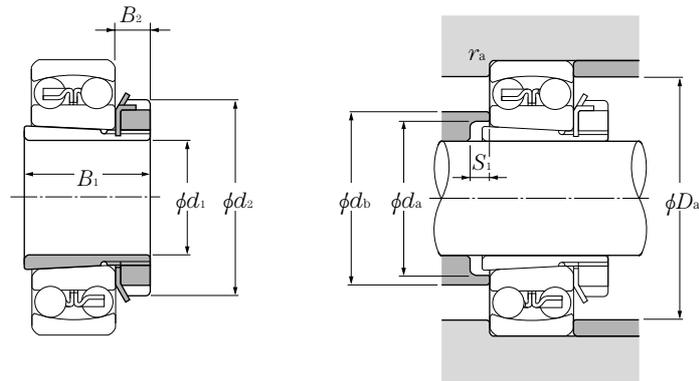

d 17 ~ 50mm

	Boundary dimensions mm				Bearing numbers	Abutment and fillet dimensions mm					Mass ¹⁾ kg (approx.)
	d ₁	B ₁	d ₂	B ₂		d _a min	d _b max	S ₁ min	D _a max	r _{as} max	
17	24	32	7		1204SK;H 204	23	27	5	41	1	0.041
	28	32	7		2204SK;H 304	24	28	5	41	1	0.045
	28	32	7		1304SK;H 304	24	31	8	45	1	0.045
	31	32	7		2304SK;H2304	24	28	5	45	1	0.049
20	26	38	8		1205SK;H 205X	28	33	5	46	1	0.07
	29	38	8		2205SK;H 305X	29	33	5	46	1	0.075
	29	38	8		1305SK;H 305X	29	37	6	55	1	0.075
	35	38	8		2305SK;H2305X	29	34	5	55	1	0.087
25	27	45	8		1206SK;H 206X	33	39	5	56	1	0.099
	31	45	8		2206SK;H 306X	34	39	5	56	1	0.109
	31	45	8		1306SK;H 306X	34	44	6	65	1	0.109
	38	45	8		2306SK;H2306X	35	40	5	65	1	0.126
30	29	52	9		1207SK;H 207X	38	46	5	65	1	0.125
	35	52	9		2207SK;H 307X	39	45	5	65	1	0.142
	35	52	9		1307SK;H 307X	39	50	7	71.5	1.5	0.142
	43	52	9		2307SK;H2307X	40	46	5	71.5	1.5	0.165
35	31	58	10		1208SK;H 208X	44	52	5	73	1	0.174
	36	58	10		2208SK;H 308X	44	50	5	73	1	0.189
	36	58	10		1308SK;H 308X	44	56	5	81.5	1.5	0.189
	46	58	10		2308SK;H2308X	45	52	5	81.5	1.5	0.224
40	33	65	11		1209SK;H 209X	49	57	5	78	1	0.227
	39	65	11		2209SK;H 309X	49	57	8	78	1	0.248
	39	65	11		1309SK;H 309X	49	61	5	91.5	1.5	0.248
	50	65	11		2309SK;H2309X	50	58	5	91.5	1.5	0.28
45	35	70	12		1210SK;H 210X	53	62	5	83	1	0.274
	42	70	12		2210SK;H 310X	54	63	10	83	1	0.303
	42	70	12		1310SK;H 310X	54	67	5	100	2	0.303
	55	70	12		2310SK;H2310X	56	65	5	100	2	0.362
50	37	75	12		1211SK;H 211X	60	70	6	91.5	1.5	0.308

1) Refers to adapter mass.
 Note: 1. For bearing dimensions, basic rated loads, and mass, refer to pages B-68 to B-70.
 2. Adapters for series 12 bearings can also be used with H2 and H3 series bearings.
 Caution: the B₁ dimension of H3 series bearings is longer than that of H2 series bearings.
 3. Adapter numbers which are appended with the code "X" indicate narrow slit type adapters which use washer with straight inner tabs.
 4. For adapter locknut and washer dimensions, please refer to pages C-2 to C-7, and C-12 to C-14.

(for self-aligning ball bearings)

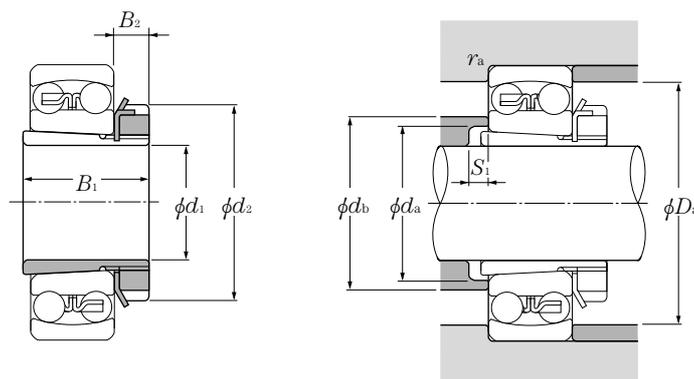

d 50 ~ 85mm

Boundary dimensions mm				Bearing numbers	Abutment and fillet dimensions mm					Mass ¹⁾ kg (approx.)
d_1	B_1	d_2	B_2		d_a min	d_b max	S_1 min	D_a max	r_{as} max	
50	45	75	12	2211SK;H 311X	60	69	11	91.5	1.5	0.345
	45	75	12	1311SK;H 311X	60	73	6	110	2	0.345
	59	75	12	2311SK;H2311X	61	71	6	110	2	0.42
55	38	80	13	1212SK;H 212X	64	76	5	101.5	1.5	0.346
	47	80	13	2212SK;H 312X	65	75	9	101.5	1.5	0.394
	47	80	13	1312SK;H 312X	65	79	5	118	2	0.394
	62	80	13	2312SK;H2312X	66	77	5	118	2	0.481
60	40	85	14	1213SK;H 213X	70	83	5	111.5	1.5	0.401
	50	85	14	2213SK;H 313X	70	81	8	111.5	1.5	0.458
	50	85	14	1313SK;H 313X	70	85	5	128	2	0.458
	65	85	14	2313SK;H2313X	72	84	5	128	2	0.557
65	43	98	15	1215SK;H 215X	80	93	5	121.5	1.5	0.707
	55	98	15	2215SK;H 315X	80	93	12	121.5	1.5	0.831
	55	98	15	1315SK;H 315X	80	97	5	148	2	0.831
	73	98	15	2315SK;H2315X	82	96	5	148	2	1.05
70	46	105	17	1216SK;H 216X	85	100	5	130	2	0.882
	59	105	17	2216SK;H 316X	86	98	12	130	2	1.03
	59	105	17	1316SK;H 316X	86	103	5	158	2	1.03
	78	105	17	2316SK;H2316X	87	103	5	158	2	1.28
75	50	110	18	1217SK;H 217X	90	106	6	140	2	1.02
	63	110	18	2217SK;H 317X	91	104	12	140	2	1.18
	63	110	18	1317SK;H 317X	91	110	6	166	2.5	1.18
	82	110	18	2317SK;H2317X	94	110	6	166	2.5	1.45
80	52	120	18	1218SK;H 218X	95	111	6	150	2	1.19
	65	120	18	2218SK;H 318X	96	112	10	150	2	1.37
	65	120	18	1318SK;H 318X	96	116	6	176	2.5	1.37
	86	120	18	2318SK;H2318X	99	117	6	176	2.5	1.69
85	55	125	19	1219SK;H 219X	101	118	7	158	2	1.37
	68	125	19	2219SK;H 319X	102	117	9	158	2	1.56

1) Refers to adapter mass.

Note: 1. For bearing dimensions, basic rated loads, and mass, refer to pages B-70 to B-72.

2. Adapters for series 12 bearings can also be used with H2 and H3 series bearings.

Caution: the B_1 dimension of H3 series bearings is longer than that of H2 series bearings.

3. Adapter numbers which are appended with the code "X" indicate narrow slit type adapters which use washer with straight inner tabs.

4. For adapter locknut and washer dimensions, please refer to pages C-2 to C-7, and C-12 to C-14.

(for self-aligning ball bearings)

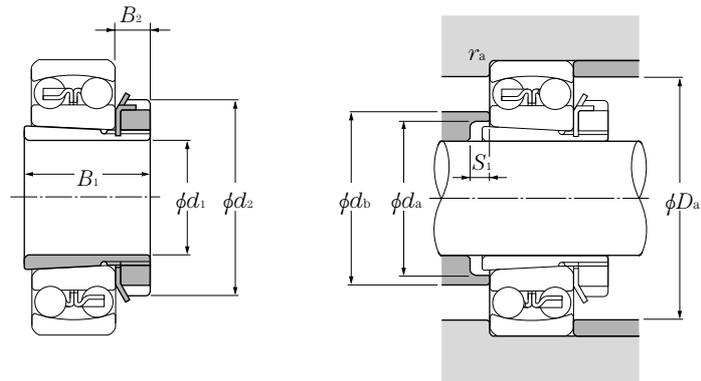

d 85 ~ 100mm

	Boundary dimensions mm				Bearing numbers	Abutment and fillet dimensions mm					Mass ¹⁾ kg (approx.)
	d_1	B_1	d_2	B_2		d_a min	d_b max	S_1 min	D_a max	r_{as} max	
85	68	125	19		1319SK;H 319X	102	123	7	186	2.5	1.56
	90	125	19		2319SK;H2319X	105	123	7	186	2.5	1.92
90	58	130	20		1220SK;H 220X	106	125	7	168	2	1.49
	71	130	20		2220SK;H 320X	107	123	8	168	2	1.69
	71	130	20		1320SK;H 320X	107	130	7	201	2.5	1.69
	97	130	20		2320SK;H2320X	110	129	7	201	2.5	2.15
100	63	145	21		1222SK;H 222X	116	138	7	188	2	1.93
	77	145	21		2222SK;H 322X	117	137	6	188	2	2.18
	77	145	21		1322SK;H 322X	117	150	9	226	2.5	2.18
	105	145	21		2322SK;H2322X	121	142	7	226	2.5	2.74

1) Refers to adapter mass.

Note: 1. For bearing dimensions, basic rated loads, and mass, refer to pages B-72 to B-73.

2. Adapters for series 12 bearings can also be used with H2 and H3 series bearings.

Caution: the B_1 dimension of H3 series bearings is longer than that of H2 series bearings.

3. Adapter numbers which are appended with the code "X" indicate narrow slit type adapters which use washer with straight inner tabs.

4. For adapter locknut and washer dimensions, please refer to pages C-2 to C-7, and C-12 to C-14.



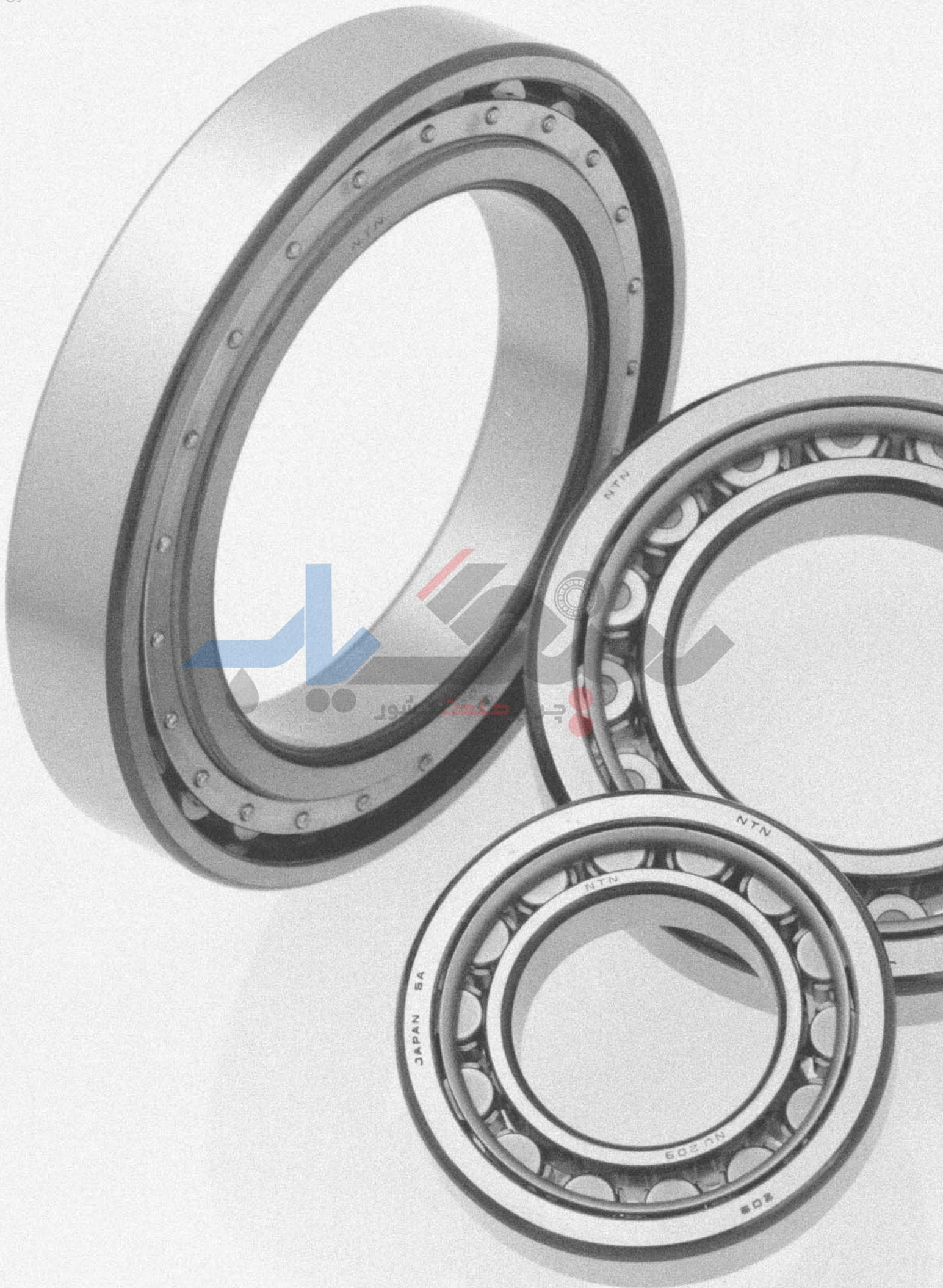

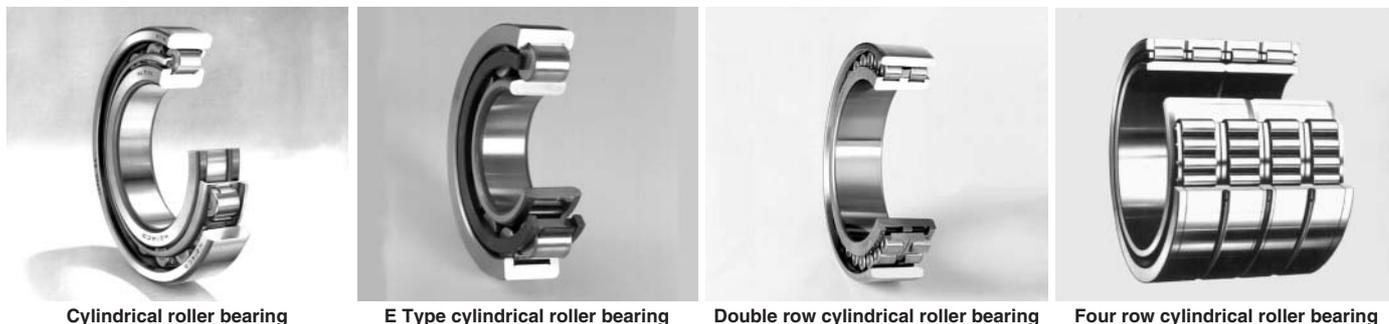

1. Types, design features, and characteristics

Since the rolling elements in cylindrical roller bearings make line contact with raceways, these bearings can accommodate heavy radial loads. The rollers are guided by ribs on either the inner or outer ring, therefore these bearings are also suitable for high speed applications. Furthermore, cylindrical roller bearings are separable, and relatively easy to install and disassemble even when interference fits are required.

Among the various types of cylindrical roller bearings, Type E has a high load capacity and its boundary dimensions are identical to standard type. HT type has a

large axial load capacity, and HL type provides extended wear life in conditions where the development of a lubricating film inside the bearing is difficult.

Double and multiple row bearing arrangements are also available.

For extremely heavy load applications, the non-separable full complement SL type bearing offers special advantages.

Table 1 shows the various types and characteristics of single row cylindrical roller bearings. **Table 2** shows the characteristics of non-standard type cylindrical roller bearings.

Table 1 Cylindrical roller bearing types and characteristics

Type code	Design	Characteristics
NU type N type	 NU type  N type	<ul style="list-style-type: none"> • NU type outer rings have double ribs; outer ring and roller as well as cage can be separated from inner ring. N type inner ring have double ribs; inner ring and roller as well as cage can be separated from outer ring. • Unable to accommodate even the lightest axial loads. • This type is extremely suitable for, and widely used as, the floating side bearing.
NJ type NF type	 NJ type  NF type	<ul style="list-style-type: none"> • NJ type has double ribs on outer ring, single rib on inner ring; NF type has single rib on outer ring, and double rib on inner ring. • Can receive single direction axial loads. • When there is no distinction between the fixed side and floating side bearing, can be used as a pair in close proximity.
NUP type NH type (NJ + HJ)	 NUP type  NH type	<ul style="list-style-type: none"> • NUP type has a collar ring attached to the ribless side of the inner ring; NH type is NJ type with an L type collar ring attached. All of these collar rings are separable, and therefore it is necessary to fix the inner ring axially. • Can accommodate axial loads in either direction. • Widely used as the shaft's fixed-side bearing.

Table 2 Non-standard type cylindrical roller bearing characteristics

Bearing type	Characteristics
E Type cylindrical roller bearing	<ul style="list-style-type: none"> Boundary dimensions are the same as the standard type, but the diameter, length and number of the rollers have been increased, as well as load capacity. Identified by addition of "E" to end of basic roller number. Enables compact design due to its high load rating. Rollers' inscribed circle diameter differs from standard type rollers and therefore cannot be interchanged. <p>Remarks: In the dimension tables, both E type and standard type are listed, but in the future JIS will change to E type.</p>
Large axial load use cylindrical roller bearings (HT type)	<ul style="list-style-type: none"> Can accommodate larger axial loads than standard type thanks to improved geometry of the rib roller end surface. Please consult NTN Engineering concerning the many factors which require consideration, such as load, lubricant, and installation conditions.
Double row cylindrical roller bearings	<ul style="list-style-type: none"> NN type and NNU type available. Widely used for applications requiring thin-walled bearings, such the main shafts of machine tools, rolling machine rollers, and in printing equipment. Internal radial clearance is adjusted for the spindle of machine tools by pressing the tapered bore of the inner ring on a tapered shaft.
Four row cylindrical roller bearings	<ul style="list-style-type: none"> Used mainly in the necks of rolling machine rollers; designed for maximum rated load to accommodate the severely limited space in the roller neck section of such equipment. Many varieties exist, including sealed types, which have been specially designed for high speed use, to prevent creeping, provide dust and water proofing properties, etc. Contact NTN Engineering.
SL type cylindrical roller bearings	<ul style="list-style-type: none"> Full complement roller bearing capable of handling heavy loads. Consult NTN Engineering regarding special application designs for SL type cylindrical roller bearings.

2. Standard cage types

Table 3 shows the standard varieties for cylindrical roller bearings.

Table 3 Standard cage types

Bearing series	Molded resin cage	Pressed cage	Machined cage
NU10	—	—	1005~10/500
NU 2 NU2E	— 204E~218E	208~230 —	232~264 219E~240E
NU22 NU22E	— 2204E~2218E	2208~2230 —	2232~2264 2219E~2240E
NU3 NU3E	— 304E~314E	308~324 —	326~356 315E~332E
NU23 NU23E	— 2304E~2311E	2308~2320 —	2322~2356 2312E~2332E
NU4	—	405~416	—

The basic load ratings listed in the dimension charts correspond to values achieved with the standard cages listed in Table 3. Furthermore, please note that even for the identical bearing, in cases where the number of rolling elements or the cage type differs, the basic rated load will also differ from the values listed in the dimension charts.

- Note: 1) Within the same bearing series, cage type is identical even if the type code (NJ, NUP, N, NF) differs.
 2) For high speed and other special applications, machined cages can be manufactured when necessary. Consult NTN Engineering.
 3) Among E type bearings (those using molded resin cages), certain varieties may also use pressed cages. Consult NTN Engineering.
 4) Although machined cages are standard for two row and four row cylindrical roller bearings, molded resin cages may also be used in some of these bearings for machine tool applications.
 5) **Due to their material properties, molded resin cages cannot be used in applications where temperatures exceed 120°C. #04 - #07 however use resin material with superior ability to withstand heat and high temperatures, which are capable of withstanding temperatures up to 150°C.**
 6) Formed resin cages capable of withstanding temperatures up to 150°C can be manufactured by request for type E (formed resin cage) of #08 or greater. For information, please contact NTN Engineering.

3. Allowable misalignment

Although values vary somewhat depending on bearing type and internal specifications, under general load conditions, to avoid the occurrence of edge loading, allowable misalignments have been set as follows:

Bearing width series 0 or 1:	0.001 rad (3.5')
Bearing width series 2:	0.0005 rad (1.5')
Double row cylindrical roller bearings ●:	0.0005 rad (1.5')

- 1 Does not include high precision bearings for machine tool main shaft applications.

4. Allowable axial load for cylindrical roller bearings

Cylindrical roller bearings with ribs on the inner and outer rings are capable of simultaneously bearing a radial load and an axial load of a certain degree. Unlike basic load ratings based on rolling fatigue, allowable axial load is determined by heat produced on the sliding surface between the ends of the rollers and rib, seizure and wear. Allowable axial load when center axial load is applied is approximately determined by formula (1), which is based upon experience and testing.

$$P_t = k \cdot d^2 \cdot P_z \dots\dots\dots(1)$$

Where:

- P_t : Allowable axial load when rotating N {kgf}
- k : Factor determined by internal design of bearing (see **Table 4**)
- d : Bearing bore mm
- P_z : Allowable surface pressure of rib MPa {kgf/mm²} (see **Diagram 1**)

If axial load is greater than radial load, the rollers will not rotate properly. The allowable axial load therefore must not exceed the value for $F_{a \max}$ given in **Table 4**.

The following are also important to operate the bearing smoothly under axial load:

- (1) Do not make the internal radial clearance any larger than necessary.**
- (2) Use lubricant with extreme pressure additive.**
- (3) Make the shoulder of the housing and shaft high enough for the rib of the bearing.**
- (4) If the bearing is to support an extreme axial load, mounting precision should be improved and the bearing should rotate slowly before actual use.**

If large cylindrical roller bearings (bore of 300 mm or more)

are to support an axial load or moment load simultaneously, please contact NTN Engineering.

NTN Engineering also offers cylindrical roller bearings for high axial loads (HT type). For details, please contact NTN Engineering.

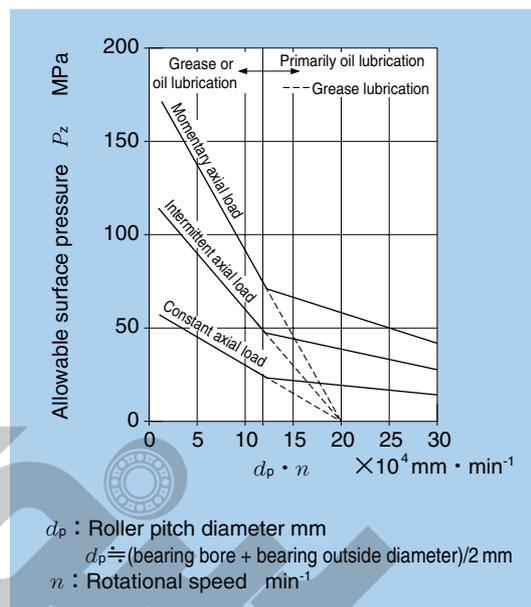
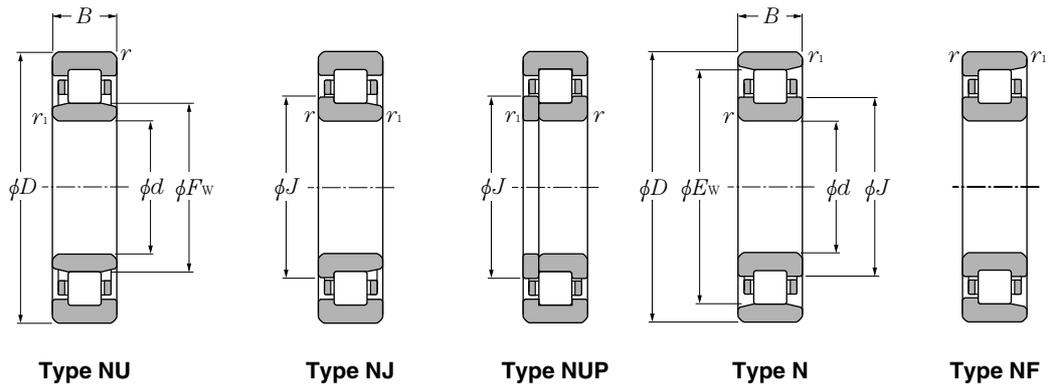

Diagram 1 Allowable surface pressure of rib

Table 4 Factor k values and allowable axial load ($F_{a \max}$)

Bearing series	k	$F_{a \max}$
NJ, NUP10	0.040	$0.4F_r$
NJ, NUP, NF, NH2, NJ, NUP, NH22		
NJ, NUP, NF, NH3, NJ, NUP, NH23		
NJ, NUP, NH2E, NJ, NUP, NH22E	0.050	$0.4F_r$
NJ, NUP, NH3E, NJ, NUP, NH23E	0.080	$0.4F_r$
NJ, NUP, NH4,	0.100	$0.4F_r$
SL01-48	0.022	$0.2F_r$
SL01-49	0.034	$0.2F_r$
SL04-50	0.044	$0.2F_r$

Cylindrical Roller Bearings



d 20 ~ 40mm

d	Boundary dimensions				Basic load ratings				Limiting speeds ¹⁾		Bearing numbers ²⁾			
	D	B	$r_{1s \min}^{(3)}$		dynamic	static	dynamic	static	min ⁻¹		type	type	type	type
	mm	mm	$r_{1s \min}^{(3)}$	$r_{1s \min}^{(3)}$	kN	C _{or}	kgf	C _{or}	grease	oil	NU	NJ	NUP	N
20	47	14	1	0.6	25.7	22.6	2 620	2 310	15 000	18 000	NU204E	NJ	NUP	—
	47	18	1	0.6	30.5	28.3	3 100	2 890	14 000	16 000	NU2204E	NJ	NUP	—
	52	15	1.1	0.6	31.5	26.9	3 200	2 740	13 000	15 000	NU304E	NJ	NUP	—
	52	21	1.1	0.6	42.0	39.0	4 300	3 950	12 000	14 000	NU2304E	NJ	NUP	—
25	47	12	0.6	0.3	15.1	14.1	1 540	1 430	16 000	19 000	NU1005	NJ	NUP	N
	52	15	1	0.6	29.3	27.7	2 990	2 830	13 000	15 000	NU205E	NJ	NUP	—
	52	18	1	0.6	35.0	34.5	3 550	3 550	11 000	13 000	NU2205E	NJ	NUP	—
	62	17	1.1	1.1	41.5	37.5	4 250	3 800	11 000	13 000	NU305E	NJ	NUP	—
	62	24	1.1	1.1	57.0	56.0	5 800	5 700	9 700	11 000	NU2305E	NJ	NUP	—
	80	21	1.5	1.5	46.5	40.0	4 750	4 050	8 500	10 000	NU405	NJ	NUP	N
30	55	13	1	0.6	19.7	19.6	2 000	2 000	14 000	16 000	NU1006	NJ	NUP	N
	62	16	1	0.6	39.0	37.5	4 000	3 800	11 000	13 000	NU206E	NJ	NUP	—
	62	20	1	0.6	49.0	50.0	5 000	5 100	9 700	11 000	NU2206E	NJ	NUP	—
	72	19	1.1	1.1	53.0	50.0	5 400	5 100	9 300	11 000	NU306E	NJ	NUP	—
	72	27	1.1	1.1	74.5	77.5	7 600	7 900	8 300	9 700	NU2306E	NJ	NUP	—
	90	23	1.5	1.5	62.5	55.0	6 400	5 600	7 300	8 500	NU406	NJ	NUP	N
35	62	14	1	0.6	22.6	23.2	2 310	2 360	12 000	15 000	NU1007	NJ	NUP	N
	72	17	1.1	0.6	50.5	50.0	5 150	5 100	9 500	11 000	NU207E	NJ	NUP	—
	72	23	1.1	0.6	61.5	65.5	6 300	6 650	8 500	10 000	NU2207E	NJ	NUP	—
	80	21	1.5	1.1	71.0	71.0	7 200	7 200	8 100	9 600	NU307E	NJ	NUP	—
	80	31	1.5	1.1	99.0	109	10 100	11 100	7 200	8 500	NU2307E	NJ	NUP	—
	100	25	1.5	1.5	75.5	69.0	7 700	7 050	6 400	7 500	NU407	NJ	NUP	N
40	68	15	1	0.6	27.3	29.0	2 780	2 950	11 000	13 000	NU1008	NJ	NUP	N
	80	18	1.1	1.1	43.5	43.0	4 450	4 350	9 400	11 000	NU208	NJ	NUP	N
	80	18	1.1	1.1	55.5	55.5	5 700	5 650	8 500	10 000	NU208E	NJ	NUP	—
	80	23	1.1	1.1	58.0	62.0	5 950	6 300	8 500	10 000	NU2208	NJ	NUP	N
	80	23	1.1	1.1	72.5	77.5	7 400	7 900	7 600	8 900	NU2208E	NJ	NUP	—
	90	23	1.5	1.5	58.5	57.0	6 000	5 800	8 000	9 400	NU308	NJ	NUP	N
	90	23	1.5	1.5	83.0	81.5	8 500	8 300	7 200	8 500	NU308E	NJ	NUP	—
	90	33	1.5	1.5	82.5	88.0	8 400	8 950	7 000	8 200	NU2308	NJ	NUP	N
	90	33	1.5	1.5	114	122	11 600	12 500	6 400	7 500	NU2308E	NJ	NUP	—
	110	27	2	2	95.5	89.0	9 750	9 100	5 700	6 700	NU408	NJ	NUP	N

1) This value achieved with machined cages; when pressed cages are used, 80% of this value is acceptable.
 2) Production switched to E type only for bearing number for which there is no standard form.
 3) Minimal allowable dimension for chamfer dimension r or r_1 .

Cylindrical Roller Bearings

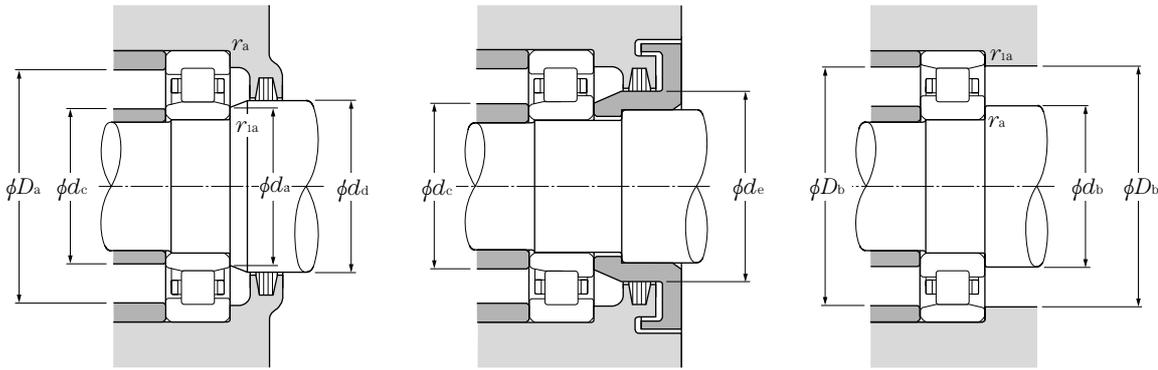

Dynamic equivalent radial load
 $P_r = F_r$

Static equivalent radial load
 $P_{or} = F_r$

type	Dimensions			Abutment and fillet dimensions										Mass	
	F_w	E_w	J	d_a min	d_b min	d_c max	d_a min	d_e min	D_a max	D_b max	D_b min ⁴⁾	r_{as} max	r_{ias} max	type NU	type N (approx.)
—	26.5	—	29.5	24	—	26	29	32	42	—	—	1	0.6	0.122	—
—	26.5	—	29.5	24	—	26	29	32	42	—	—	1	0.6	0.158	—
—	27.5	—	31.1	24	—	27	30	33	45.5	—	—	1	0.6	0.176	—
—	27.5	—	31.1	24	—	27	30	33	45.5	—	—	1	0.6	0.242	—
—	30.5	41.5	32.7	27	29	30	32	33	43	45	42.5	0.6	0.3	0.092	0.091
—	31.5	—	34.5	29	—	31	34	37	47	—	—	1	0.6	0.151	—
—	31.5	—	34.5	29	—	31	34	37	47	—	—	1	0.6	0.186	—
—	34	—	38	31.5	—	33	37	40	55.5	—	—	1	1	0.275	—
—	34	—	38	31.5	—	33	37	40	55.5	—	—	1	1	0.386	—
NF	38.8	62.8	43.6	33	33	38	41	46	72	72	64	1.5	1.5	0.55	0.536
—	36.5	48.5	38.9	34	35	35	38	39.5	50	51	49.5	1	0.6	0.13	0.128
—	37.5	—	41.1	34	—	37	40	44	57	—	—	1	0.6	0.226	—
—	37.5	—	41.1	34	—	37	40	44	57	—	—	1	0.6	0.297	—
—	40.5	—	44.9	36.5	—	40	44	48	65.5	—	—	1	1	0.398	—
—	40.5	—	44.9	36.5	—	40	44	48	65.5	—	—	1	1	0.58	—
NF	45	73	50.5	38	38	44	47	52	82	82	74	1.5	1.5	0.751	0.732
—	42	55	44.6	39	40	41	44	45	57	58	56	1	0.6	0.179	0.176
—	44	—	48	39	—	43	46	50	65.5	—	—	1	0.6	0.327	—
—	44	—	48	39	—	43	46	50	65.5	—	—	1	0.6	0.455	—
—	46.2	—	51	41.5	—	45	48	53	72	—	—	1.5	1	0.545	—
—	46.2	—	51	41.5	—	45	48	53	72	—	—	1.5	1	0.78	—
NF	53	83	59	43	43	52	55	61	92	92	84	1.5	1.5	0.99	0.965
—	47	61	49.8	44	45	46	49	50.5	63	64	62	1	0.6	0.22	0.217
NF	50	70	54.2	46.5	46.5	49	52	56	73.5	73.5	72	1	1	0.378	0.37
—	49.5	—	53.9	46.5	—	49	52	56	73.5	—	—	1	1	0.426	—
—	50	70	54.2	46.5	46.5	49	52	56	73.5	73.5	72	1	1	0.49	0.48
—	49.5	—	53.9	46.5	—	49	52	56	73.5	—	—	1	1	0.552	—
NF	53.5	77.5	58.4	48	48	51	55	60	82	82	80	1.5	1.5	0.658	0.643
—	52	—	57.6	48	—	51	55	60	82	—	—	1.5	1.5	0.754	—
—	53.5	77.5	58.4	48	48	51	55	60	82	82	80	1.5	1.5	0.951	0.932
—	52	—	57.6	48	—	51	55	60	82	—	—	1.5	1.5	1.06	—
NF	58	92	64.8	49	49	57	60	67	101	101	93	2	2	1.3	1.27

4) Does not apply to side of the outer ring rib of type **NF** bearings.

Cylindrical Roller Bearings

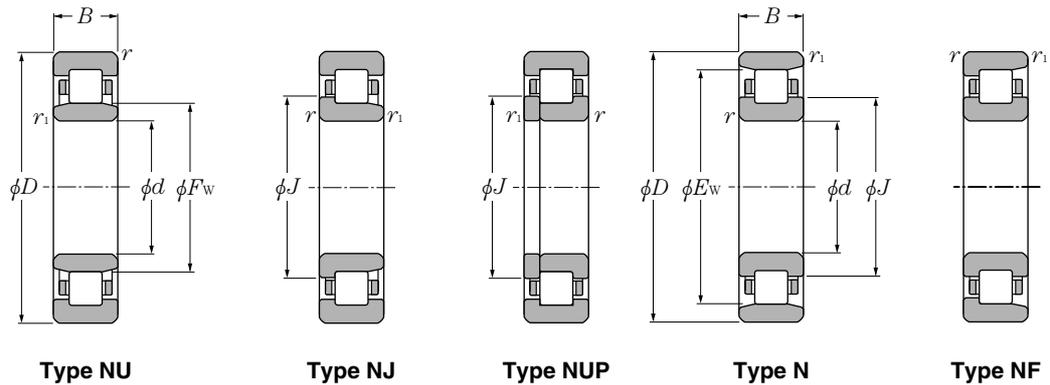

d 45 ~ 60mm

d	Boundary dimensions				Basic load ratings				Limiting speeds ¹⁾		Bearing numbers ²⁾			
	D	B	mm		kN		kgf		min ⁻¹		type	type	type	type
			$r_s \min^{(3)}$	$r_{1s} \min^{(3)}$	C_r	C_{or}	C_r	C_{or}	grease	oil	NU	NJ	NUP	N
45	75	16	1	0.6	31.0	34.0	3 200	3 450	9 900	12 000	NU1009	NJ	NUP	N
	85	19	1.1	1.1	46.0	47.0	4 700	4 800	8 400	9 900	NU209	NJ	NUP	N
	85	19	1.1	1.1	63.0	66.5	6 450	6 800	7 600	9 000	NU209E	NJ	NUP	—
	85	23	1.1	1.1	61.5	68.0	6 250	6 900	7 600	9 000	NU2209	NJ	NUP	N
	85	23	1.1	1.1	76.0	84.5	7 750	8 600	6 800	8 000	NU2209E	NJ	NUP	—
	100	25	1.5	1.5	74.0	71.0	7 550	7 250	7 200	8 400	NU309	NJ	NUP	N
	100	25	1.5	1.5	97.5	98.5	9 950	10 000	6 500	7 600	NU309E	NJ	NUP	—
	100	36	1.5	1.5	99.0	104	10 100	10 600	6 300	7 400	NU2309	NJ	NUP	N
	100	36	1.5	1.5	137	153	14 000	15 600	5 700	6 800	NU2309E	NJ	NUP	—
120	29	2	2	107	102	10 900	10 400	5 100	6 000	NU409	NJ	NUP	N	
50	80	16	1	0.6	32.0	36.0	3 300	3 700	8 900	11 000	NU1010	NJ	NUP	N
	90	20	1.1	1.1	48.0	51.0	4 900	5 200	7 600	9 000	NU210	NJ	NUP	N
	90	20	1.1	1.1	66.0	72.0	6 750	7 350	6 900	8 100	NU210E	NJ	NUP	—
	90	23	1.1	1.1	64.0	73.5	6 550	7 500	6 900	8 100	NU2210	NJ	NUP	N
	90	23	1.1	1.1	79.5	91.5	8 100	9 350	6 200	7 300	NU2210E	NJ	NUP	—
	110	27	2	2	87.0	86.0	8 850	8 800	6 500	7 700	NU310	NJ	NUP	N
	110	27	2	2	110	113	11 200	11 500	5 900	6 900	NU310E	NJ	NUP	—
	110	40	2	2	121	131	12 300	13 400	5 700	6 700	NU2310	NJ	NUP	N
	110	40	2	2	163	187	16 600	19 000	5 200	6 100	NU2310E	NJ	NUP	—
130	31	2.1	2.1	129	124	13 200	12 600	4 700	5 500	NU410	NJ	NUP	N	
55	90	18	1.1	1	37.5	44.0	3 850	4 450	8 200	9 700	NU1011	NJ	NUP	N
	100	21	1.5	1.1	58.0	62.5	5 900	6 350	6 900	8 200	NU211	NJ	NUP	N
	100	21	1.5	1.1	82.5	93.0	8 400	9 500	6 300	7 400	NU211E	NJ	NUP	—
	100	25	1.5	1.1	75.5	87.0	7 700	8 900	6 300	7 400	NU2211	NJ	NUP	N
	100	25	1.5	1.1	97.0	114	9 900	11 700	5 600	6 600	NU2211E	NJ	NUP	—
	120	29	2	2	111	111	11 300	11 400	5 900	7 000	NU311	NJ	NUP	N
	120	29	2	2	137	143	14 000	14 600	5 300	6 300	NU311E	NJ	NUP	—
	120	43	2	2	148	162	15 100	16 500	5 200	6 100	NU2311	NJ	NUP	N
	120	43	2	2	201	233	20 500	23 800	4 700	5 600	NU2311E	NJ	NUP	—
140	33	2.1	2.1	139	138	14 200	14 100	4 300	5 000	NU411	NJ	NUP	N	
60	95	18	1.1	1	40.0	48.5	4 100	4 950	7 500	8 800	NU1012	NJ	NUP	N
	110	22	1.5	1.5	68.5	75.0	7 000	7 650	6 400	7 600	NU212	NJ	NUP	N
	110	22	1.5	1.5	97.5	107	9 950	10 900	5 800	6 800	NU212E	NJ	NUP	—
	110	28	1.5	1.5	96.0	116	9 800	11 800	5 800	6 800	NU2212	NJ	NUP	N

1) This value achieved with machined cages; when pressed cages are used, 80% of this value is acceptable.
 2) Production switched to E type only for bearing number for which there is no standard form.
 3) Minimal allowable dimension for chamfer dimension r or r_1 .

Cylindrical Roller Bearings

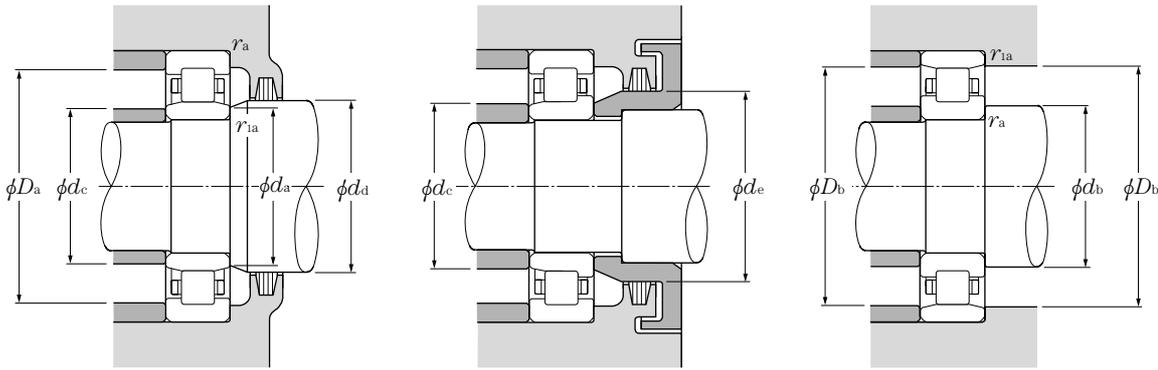

Dynamic equivalent radial load

$$P_r = F_r$$

Static equivalent radial load

$$P_{or} = F_r$$

type	Dimensions			Abutment and fillet dimensions										Mass	
	mm			mm										kg	
NF	F_w	E_w	J	d_a min	d_b min	d_c max	d_d min	d_e min	D_a max	D_b max	D_b min ⁴⁾	r_{as} max	r_{ias} max	type NU (approx.)	type N
—	52.5	67.5	55.5	49	50	52	54	56	70	71	68.5	1	0.6	0.28	0.276
NF	55	75	59	51.5	51.5	54	57	61	78.5	78.5	77	1	1	0.432	0.423
—	54.5	—	58.9	51.5	—	54	57	61	78.5	—	—	1	1	0.495	—
—	55	75	59	51.5	51.5	54	57	61	78.5	78.5	77	1	1	0.53	0.52
—	54.5	—	58.9	51.5	—	54	57	61	78.5	—	—	1	1	0.6	—
NF	58.5	86.5	64	53	53	57	60	66	92	92	89	1.5	1.5	0.877	0.857
—	58.5	—	64.5	53	—	57	60	66	92	—	—	1.5	1.5	0.996	—
—	58.5	86.5	64	53	53	57	60	66	92	92	89	1.5	1.5	1.27	1.24
—	58.5	—	64.5	53	—	57	60	66	92	—	—	1.5	1.5	1.41	—
NF	64.5	100.5	71.8	54	54	63	66	74	111	111	102	2	2	1.62	1.58
—	57.5	72.5	60.5	54	55	57	59	61	75	76	73.5	1	0.6	0.295	0.291
NF	60.4	80.4	64.6	56.5	56.5	58	62	67	83.5	83.5	83	1	1	0.47	0.46
—	59.5	—	63.9	56.5	—	58	62	67	83.5	—	—	1	1	0.54	—
—	60.4	80.4	64.6	56.5	56.5	58	62	67	83.5	83.5	83	1	1	0.571	0.56
—	59.5	—	63.9	56.5	—	58	62	67	83.5	—	—	1	1	0.652	—
NF	65	95	71	59	59	63	67	73	101	101	98	2	2	1.14	1.11
—	65	—	71.4	59	—	63	67	73	101	—	—	2	2	1.3	—
—	65	95	71	59	59	63	67	73	101	101	98	2	2	1.7	1.67
—	65	—	71.4	59	—	63	67	73	101	—	—	2	2	1.9	—
NF	70.8	110.8	78.8	61	61	69	73	81	119	119	112	2	2	2.02	1.97
—	64.5	80.5	67.7	60	61.5	63	66	68.5	83.5	85	81.5	1	1	0.442	0.435
NF	66.5	88.5	70.8	61.5	63	65	68	73	92	93.5	91	1.5	1	0.638	0.626
—	66	—	70.8	61.5	—	65	68	73	92	—	—	1.5	1	0.718	—
—	66.5	88.5	70.8	61.5	63	65	68	73	92	93.5	91	1.5	1	0.773	0.758
—	66	—	70.8	61.5	—	65	68	73	92	—	—	1.5	1	0.968	—
NF	70.5	104.5	77.2	64	64	69	72	80	111	111	107	2	2	1.45	1.42
—	70.5	—	77.7	64	—	69	72	80	111	—	—	2	2	1.65	—
—	70.5	104.5	77.2	64	64	69	72	80	111	111	107	2	2	2.17	2.13
—	70.5	—	77.7	64	—	69	72	80	111	—	—	2	2	2.37	—
NF	77.2	117.2	85.2	66	66	76	79	87	129	129	119	2	2	2.48	2.42
—	69.5	85.5	72.7	65	66.5	68	71	73.5	88.5	90	86.5	1	1	0.474	0.467
NF	73.5	97.5	78.4	68	68	71	75	80	102	102	100	1.5	1.5	0.818	0.802
—	72	—	77.6	68	—	71	75	80	102	—	—	1.5	1.5	0.923	—
—	73.5	97.5	78.4	68	68	71	75	80	102	102	100	1.5	1.5	1.06	1.04

4) Does not apply to side of the outer ring rib of type NF bearings.

Cylindrical Roller Bearings

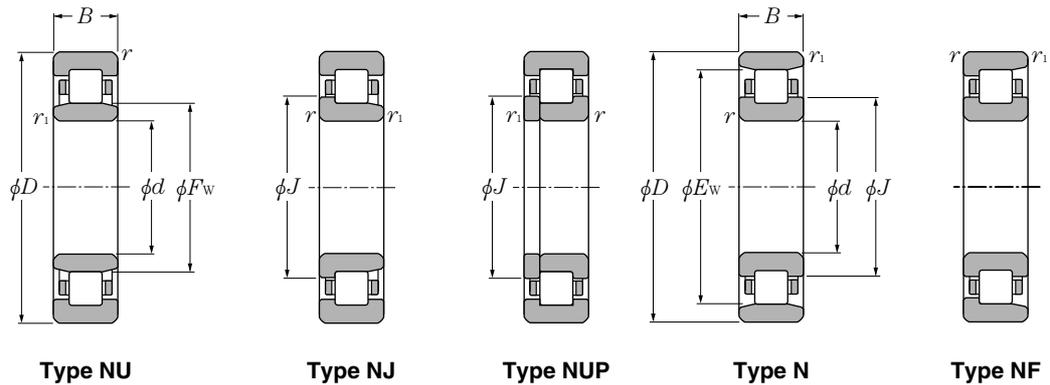

d 60 ~ 75mm

d	Boundary dimensions				Basic load ratings				Limiting speeds ¹⁾		Bearing numbers ²⁾			
	D	B	$r_{s \min}^{(3)}$		dynamic	static	dynamic	static	min ⁻¹		type	type	type	type
	mm	mm	r_s	r_1	kN	C _{or}	kgf	C _{or}	grease	oil	NU	NJ	NUP	N
60	110	28	1.5	1.5	131	157	13 400	16 000	5 200	6 100	NU2212E	NJ	NUP	—
	130	31	2.1	2.1	124	126	12 600	12 900	5 500	6 500	NU312	NJ	NUP	N
	130	31	2.1	2.1	150	157	15 200	16 000	4 900	5 800	NU312E	NJ	NUP	—
	130	46	2.1	2.1	169	188	17 200	19 200	4 800	5 700	NU2312	NJ	NUP	N
	130	46	2.1	2.1	222	262	22 700	26 700	4 400	5 200	NU2312E	NJ	NUP	—
	150	35	2.1	2.1	167	168	17 100	17 200	3 900	4 600	NU412	NJ	NUP	N
65	100	18	1.1	1	41.0	51.0	4 200	5 200	7 000	8 200	NU1013	NJ	NUP	N
	120	23	1.5	1.5	84.0	94.5	8 550	9 650	5 900	7 000	NU213	NJ	NUP	N
	120	23	1.5	1.5	108	119	11 000	12 100	5 400	6 300	NU213E	NJ	NUP	—
	120	31	1.5	1.5	120	149	12 200	15 200	5 400	6 300	NU2213	NJ	NUP	N
	120	31	1.5	1.5	149	181	15 200	18 400	4 800	5 600	NU2213E	NJ	NUP	—
	140	33	2.1	2.1	135	139	13 800	14 200	5 100	6 000	NU313	NJ	NUP	N
	140	33	2.1	2.1	181	191	18 400	19 500	4 600	5 400	NU313E	NJ	NUP	—
	140	48	2.1	2.1	188	212	19 100	21 700	4 400	5 200	NU2313	NJ	NUP	N
	140	48	2.1	2.1	248	287	25 200	29 300	4 100	4 800	NU2313E	NJ	NUP	—
160	37	2.1	2.1	182	186	18 600	19 000	3 600	4 300	NU413	NJ	NUP	N	
70	110	20	1.1	1	58.5	70.5	5 950	7 200	6 500	7 600	NU1014	NJ	NUP	N
	125	24	1.5	1.5	83.5	95.0	8 500	9 700	5 500	6 500	NU214	NJ	NUP	N
	125	24	1.5	1.5	119	137	12 100	14 000	5 000	5 900	NU214E	NJ	NUP	—
	125	31	1.5	1.5	119	151	12 200	15 400	5 000	5 900	NU2214	NJ	NUP	N
	125	31	1.5	1.5	156	194	15 900	19 800	4 500	5 200	NU2214E	NJ	NUP	—
	150	35	2.1	2.1	158	168	16 100	17 200	4 700	5 500	NU314	NJ	NUP	N
	150	35	2.1	2.1	205	222	20 900	22 600	4 200	5 000	NU314E	NJ	NUP	—
	150	51	2.1	2.1	223	262	22 700	26 700	4 100	4 800	NU2314	NJ	NUP	N
	150	51	2.1	2.1	274	325	27 900	33 000	3 800	4 400	NU2314E	NJ	NUP	—
	180	42	3	3	228	236	23 200	24 000	3 400	4 000	NU414	NJ	NUP	N
75	115	20	1.1	1	60.0	74.5	6 100	7 600	6 100	7 100	NU1015	NJ	NUP	N
	130	25	1.5	1.5	96.5	111	9 850	11 300	5 100	6 000	NU215	NJ	NUP	N
	130	25	1.5	1.5	130	156	13 300	16 000	4 700	5 500	NU215E	NJ	NUP	—
	130	31	1.5	1.5	130	162	13 200	16 500	4 700	5 500	NU2215	NJ	NUP	N
	130	31	1.5	1.5	162	207	16 500	21 100	4 200	4 900	NU2215E	NJ	NUP	—
	160	37	2.1	2.1	190	205	19 400	20 900	4 400	5 200	NU315	NJ	NUP	N
	160	37	2.1	2.1	240	263	24 500	26 800	4 000	4 700	NU315E	NJ	NUP	—
	160	55	2.1	2.1	258	300	26 300	31 000	3 800	4 500	NU2315	NJ	NUP	N

1) This value achieved with machined cages; when pressed cages are used, 80% of this value is acceptable.
 2) Production switched to E type only for bearing number for which there is no standard form.
 3) Minimal allowable dimension for chamfer dimension r or r_1 .

Cylindrical Roller Bearings

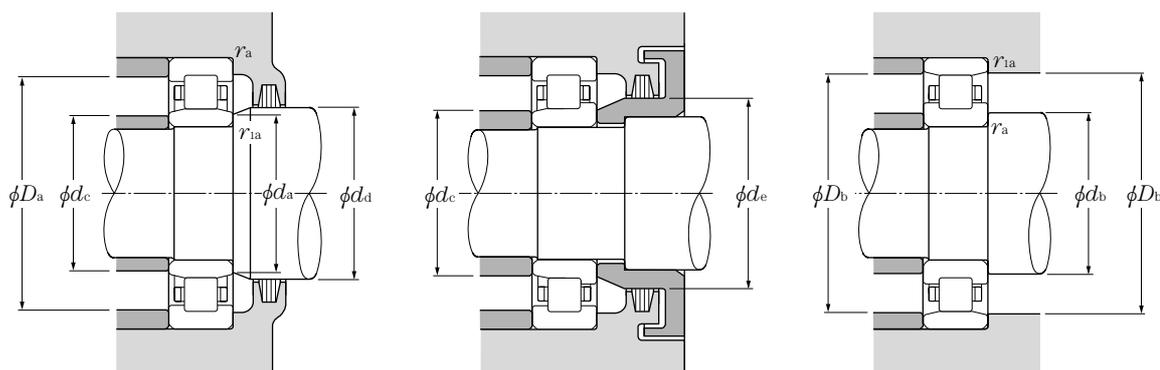

Dynamic equivalent radial load

$$P_r = F_r$$

Static equivalent radial load

$$P_{or} = F_r$$

type	Dimensions			Abutment and fillet dimensions										Mass	
	F_w	E_w	J	d_a min	d_b min	d_c max	d_d min	d_e min	D_a max	D_b max	D_b min ⁴⁾	r_{as} max	r_{ias} max	type NU (approx.)	type N
—	72	—	77.6	68	—	71	75	80	102	—	—	1.5	1.5	1.21	—
NF	77	113	84.2	71	71	75	79	86	119	119	116	2	2	1.8	1.76
—	77	—	84.6	71	—	75	79	86	119	—	—	2	2	2.05	—
—	77	113	84.2	71	71	75	79	86	119	119	116	2	2	2.71	2.66
—	77	—	84.6	71	—	75	79	86	119	—	—	2	2	2.96	—
NF	83	127	91.8	71	71	82	85	94	139	139	128	2	2	3	2.93
—	74.5	90.5	77.7	70	71.5	73	76	78.5	93.5	95	91.5	1	1	0.485	0.477
NF	79.6	105.6	84.8	73	73	77	81	87	112	112	108	1.5	1.5	1.02	1
—	78.5	—	84.5	73	—	77	81	87	112	—	—	1.5	1.5	1.21	—
—	79.6	105.6	84.8	73	73	77	81	87	112	112	108	1.5	1.5	1.4	1.37
—	78.5	—	84.5	73	—	77	81	87	112	—	—	1.5	1.5	1.6	—
NF	83.5	121.5	91	76	76	81	85	93	129	129	125	2	2	2.23	2.18
—	82.5	—	91	76	—	81	85	93	129	—	—	2	2	2.54	—
—	83.5	121.5	91	76	76	81	85	93	129	129	125	2	2	3.27	3.2
—	82.5	—	91	76	—	81	85	93	129	—	—	2	2	3.48	—
NF	89.3	135.3	98.5	76	76	88	91	100	149	149	137	2	2	3.6	3.5
—	80	100	84	75	76.5	78	82	85	103.5	105	101	1	1	0.699	0.689
NF	84.5	110.5	89.6	78	78	82	86	92	117	117	114	1.5	1.5	1.12	1.1
—	83.5	—	89.5	78	—	82	86	92	117	—	—	1.5	1.5	1.3	—
—	84.5	110.5	89.6	78	78	82	86	92	117	117	114	1.5	1.5	1.47	1.44
—	83.5	—	89.5	78	—	82	86	92	117	—	—	1.5	1.5	1.7	—
NF	90	130	98	81	81	87	92	100	139	139	134	2	2	2.71	2.65
—	89	—	98	81	—	87	92	100	139	—	—	2	2	3.1	—
—	90	130	98	81	81	87	92	100	139	139	134	2	2	3.98	3.9
—	89	—	98	81	—	87	92	100	139	—	—	2	2	4.25	—
NF	100	152	110.5	83	83	99	102	112	167	167	153	2.5	2.5	5.24	5.1
—	85	105	89	80	81.5	83	87	90	108.5	110	106	1	1	0.738	0.727
NF	88.5	116.5	94	83	83	87	90	96	122	122	120	1.5	1.5	1.23	1.21
—	88.5	—	94.5	83	—	87	90	96	122	—	—	1.5	1.5	1.41	—
—	88.5	116.5	94	83	83	87	90	96	122	122	120	1.5	1.5	1.55	1.52
—	88.5	—	94.5	83	—	87	90	96	122	—	—	1.5	1.5	1.79	—
NF	95.5	139.5	104.2	86	86	93	97	106	149	149	143	2	2	3.28	3.21
—	95	—	104.6	86	—	93	97	106	149	—	—	2	2	3.74	—
—	95.5	139.5	104.2	86	86	93	97	106	149	149	143	2	2	4.87	4.77

4) Does not apply to side of the outer ring rib of type **NF** bearings.

Cylindrical Roller Bearings

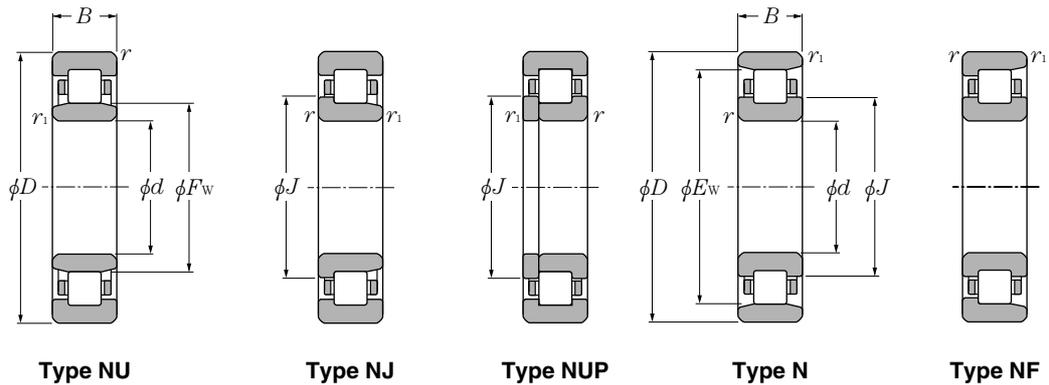

d 75 ~ 95mm

d	Boundary dimensions			Basic load ratings						Limiting speeds ¹⁾		Bearing numbers ²⁾			
	D	B	mm	dynamic	static	dynamic	static	dynamic	static	grease	oil	type	type	type	type
	mm	mm	$r_s \min^{(3)}$	$r_{1s} \min^{(3)}$	C_r	C_{or}	C_r	C_{or}	C_r	C_{or}	min ⁻¹	min ⁻¹	NU	NJ	NUP
75	160	55	2.1	2.1	330	395	33 500	40 000	3 500	4 100	NU2315E	NJ	NUP	—	
	190	45	3	3	262	274	26 800	27 900	3 200	3 700	NU415	NJ	NUP	N	
80	125	22	1.1	1	72.5	90.5	7 400	9 250	5 700	6 700	NU1016	NJ	NUP	N	
	140	26	2	2	106	122	10 800	12 500	4 800	5 700	NU216	NJ	NUP	N	
	140	26	2	2	139	167	14 200	17 000	4 400	5 100	NU216E	NJ	NUP	—	
	140	33	2	2	147	186	15 000	19 000	4 400	5 100	NU2216	NJ	NUP	N	
	140	33	2	2	186	243	19 000	24 800	3 900	4 600	NU2216E	NJ	NUP	—	
	170	39	2.1	2.1	190	207	19 400	21 100	4 100	4 800	NU316	NJ	NUP	N	
	170	39	2.1	2.1	256	282	26 100	28 800	3 700	4 400	NU316E	NJ	NUP	—	
	170	58	2.1	2.1	274	330	27 900	34 000	3 600	4 200	NU2316	NJ	NUP	N	
	170	58	2.1	2.1	355	430	36 500	44 000	3 300	3 900	NU2316E	NJ	NUP	—	
	200	48	3	3	299	315	30 500	32 000	3 000	3 500	NU416	NJ	NUP	N	
85	130	22	1.1	1	74.5	95.5	7 600	9 750	5 400	6 300	NU1017	NJ	NUP	N	
	150	28	2	2	120	140	12 300	14 300	4 500	5 300	NU217	NJ	NUP	N	
	150	28	2	2	167	199	17 000	20 300	4 100	4 800	NU217E	NJ	NUP	—	
	150	36	2	2	170	218	17 300	22 200	4 100	4 800	NU2217	NJ	NUP	N	
	150	36	2	2	217	279	22 200	28 400	3 700	4 300	NU2217E	NJ	NUP	—	
	180	41	3	3	212	228	21 600	23 300	3 900	4 600	NU317	NJ	NUP	N	
	180	41	3	3	291	330	29 700	33 500	3 500	4 100	NU317E	NJ	NUP	—	
	180	60	3	3	315	380	32 000	39 000	3 400	4 000	NU2317	NJ	NUP	N	
180	60	3	3	395	485	40 000	49 500	3 100	3 700	NU2317E	NJ	NUP	—		
90	140	24	1.5	1.1	88.0	114	9 000	11 700	5 100	5 900	NU1018	NJ	NUP	N	
	160	30	2	2	152	178	15 500	18 100	4 300	5 000	NU218	NJ	NUP	N	
	160	30	2	2	182	217	18 500	22 200	3 900	4 600	NU218E	NJ	NUP	—	
	160	40	2	2	197	248	20 100	25 300	3 900	4 600	NU2218	NJ	NUP	N	
	160	40	2	2	242	315	24 700	32 000	3 500	4 100	NU2218E	NJ	NUP	—	
	190	43	3	3	240	265	24 500	27 100	3 700	4 300	NU318	NJ	NUP	N	
	190	43	3	3	315	355	32 000	36 000	3 300	3 900	NU318E	NJ	NUP	—	
	190	64	3	3	325	395	33 500	40 000	3 200	3 800	NU2318	NJ	NUP	N	
190	64	3	3	435	535	44 500	54 500	2 900	3 400	NU2318E	NJ	NUP	—		
95	145	24	1.5	1.1	90.5	120	9 250	12 300	4 800	5 600	NU1019	NJ	NUP	N	
	170	32	2.1	2.1	166	195	16 900	19 900	4 000	4 700	NU219	NJ	NUP	N	
	170	32	2.1	2.1	220	265	22 500	27 000	3 600	4 300	NU219E	NJ	NUP	—	

1) This value achieved with machined cages; when pressed cages are used, 80% of this value is acceptable.
 2) Production switched to E type only for bearing number for which there is no standard form.
 3) Minimal allowable dimension for chamfer dimension r or r_1 .

Cylindrical Roller Bearings

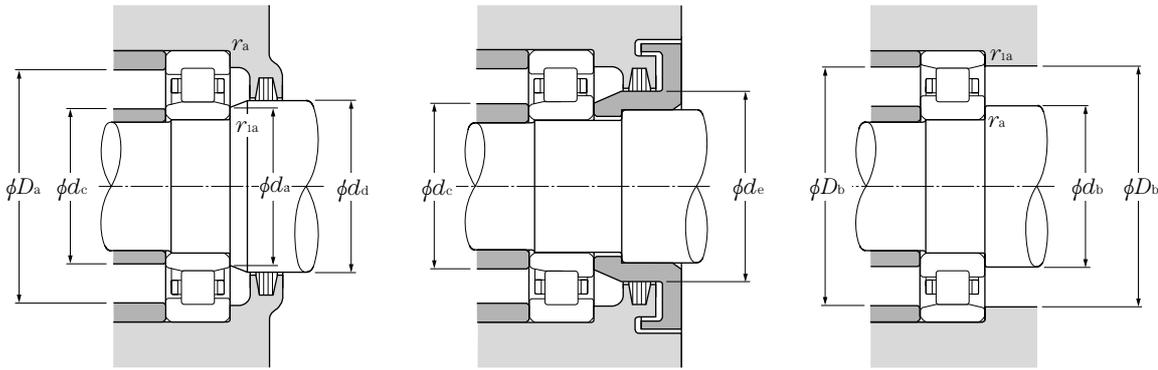

Dynamic equivalent radial load

$$P_r = F_r$$

Static equivalent radial load

$$P_{or} = F_r$$

type	Dimensions			Abutment and fillet dimensions										Mass	
	F_w	E_w	J	d_a min	d_b min	d_c max	d_a min	d_e min	D_a max	D_b max	D_b min ⁴⁾	r_{as} max	r_{ias} max	type NU (approx.)	type N
—	95	—	104.6	86	—	93	97	106	149	—	—	2	2	5.25	—
NF	104.5	160.5	116	88	88	103	107	118	177	177	162	2.5	2.5	6.22	6.06
—	91.5	113.5	95.9	85	86.5	90	94	97	118.5	120	114.5	1	1	0.98	0.965
NF	95.3	125.3	101.2	89	89	94	97	104	131	131	128	2	2	1.5	1.47
—	95.3	—	101.7	89	—	94	97	104	131	—	—	2	2	1.67	—
—	95.3	125.3	101.2	89	89	94	97	104	131	131	128	2	2	1.93	1.89
—	95.3	—	101.7	89	—	94	97	104	131	—	—	2	2	2.12	—
NF	103	147	111.8	91	91	99	105	114	159	159	151	2	2	3.86	3.77
—	101	—	111	91	—	99	105	114	159	—	—	2	2	4.22	—
—	103	147	111.8	91	91	99	105	114	159	159	151	2	2	5.79	5.67
—	101	—	111	91	—	99	105	114	159	—	—	2	2	6.25	—
NF	110	170	122	93	93	109	112	124	187	187	172	2.5	2.5	7.32	7.14
—	96.5	118.5	100.9	90	91.5	95	99	102	123.5	125	119.5	1	1	1.03	1.01
NF	101.8	133.8	108.2	94	94	99	104	110	141	141	137	2	2	1.87	1.83
—	100.5	—	107.7	94	—	99	104	110	141	—	—	2	2	2.11	—
—	101.8	133.8	108.2	94	94	99	104	110	141	141	137	2	2	2.44	2.39
—	100.5	—	107.7	94	—	99	104	110	141	—	—	2	2	2.68	—
NF	108	156	117.5	98	98	106	110	119	167	167	160	2.5	2.5	4.54	4.44
—	108	—	118.4	98	—	106	110	119	167	—	—	2.5	2.5	4.81	—
—	108	156	117.5	98	98	106	110	119	167	167	160	2.5	2.5	6.7	6.57
—	108	—	118.4	98	—	106	110	119	167	—	—	2.5	2.5	7.16	—
—	103	127	107.8	96.5	98	101	106	109	132	133.5	129	1.5	1	1.33	1.31
NF	107	143	114.2	99	99	105	109	116	151	151	146	2	2	2.3	2.25
—	107	—	114.6	99	—	105	109	116	151	—	—	2	2	2.44	—
—	107	143	114.2	99	99	105	109	116	151	151	146	2	2	3.1	3.04
—	107	—	114.6	99	—	105	109	116	151	—	—	2	2	3.33	—
NF	115	165	125	103	103	111	117	127	177	177	169	2.5	2.5	5.3	5.18
—	113.5	—	124.7	103	—	111	117	127	177	—	—	2.5	2.5	5.72	—
—	115	165	125	103	103	111	117	127	177	177	169	2.5	2.5	7.95	7.79
—	113.5	—	124.7	103	—	111	117	127	177	—	—	2.5	2.5	8.56	—
—	108	132	112.8	101.5	103	106	111	114	137	138.5	134	1.5	1	1.4	1.38
NF	113.5	151.5	121	106	106	111	116	123	159	159	155	2	2	2.78	2.72
—	112.5	—	121	106	—	111	116	123	159	—	—	2	2	3.02	—

4) Does not apply to side of the outer ring rib of type **NF** bearings.

Cylindrical Roller Bearings

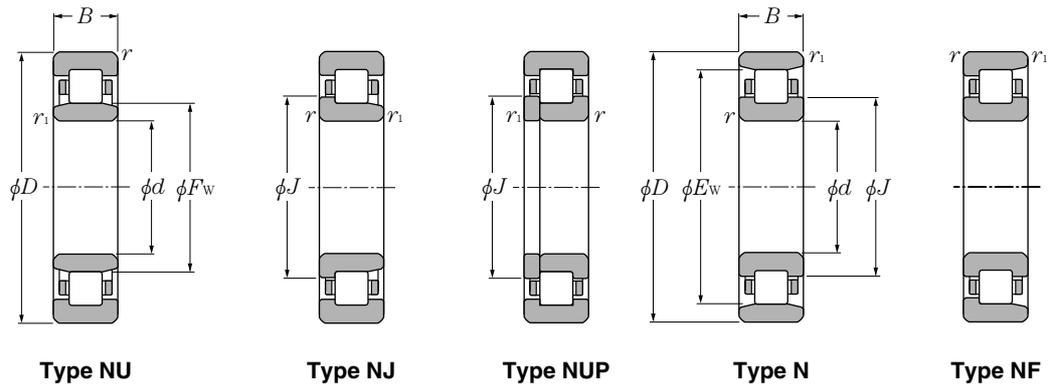

d 95 ~ 120mm

d	Boundary dimensions				Basic load ratings				Limiting speeds ¹⁾		Bearing numbers ²⁾			
	D	B	mm		kN		kgf		min ⁻¹		type	type	type	type
			r _{s min} ³⁾	r _{1s min} ³⁾	C _r	C _{or}	C _r	C _{or}	grease	oil	NU	NJ	NUP	N
95	170	43	2.1	2.1	230	298	23 500	30 500	3 600	4 300	NU2219	NJ	NUP	N
	170	43	2.1	2.1	286	370	29 200	38 000	3 300	3 800	NU2219E	NJ	NUP	—
	200	45	3	3	259	285	26 400	29 500	3 400	4 000	NU319	NJ	NUP	N
	200	45	3	3	335	385	34 000	39 500	3 100	3 600	NU319E	NJ	NUP	—
	200	67	3	3	370	460	38 000	47 000	3 000	3 500	NU2319	NJ	NUP	N
	200	67	3	3	460	585	47 000	59 500	2 700	3 200	NU2319E	NJ	NUP	—
100	150	24	1.5	1.1	93.0	126	9 500	12 800	4 600	5 400	NU1020	NJ	NUP	N
	180	34	2.1	2.1	183	217	18 600	22 200	3 800	4 500	NU220	NJ	NUP	N
	180	34	2.1	2.1	249	305	25 400	31 000	3 500	4 100	NU220E	NJ	NUP	—
	180	46	2.1	2.1	258	340	26 300	34 500	3 500	4 100	NU2220	NJ	NUP	N
	180	46	2.1	2.1	335	445	34 000	45 500	3 100	3 600	NU2220E	NJ	NUP	—
	215	47	3	3	299	335	30 500	34 500	3 300	3 800	NU320	NJ	NUP	N
	215	47	3	3	380	425	38 500	43 500	2 900	3 500	NU320E	NJ	NUP	—
	215	73	3	3	410	505	42 000	51 500	2 900	3 400	NU2320	NJ	NUP	N
215	73	3	3	570	715	58 000	73 000	2 600	3 100	NU2320E	NJ	NUP	—	
105	160	26	2	1.1	105	142	10 700	14 500	4 300	5 100	NU1021	NJ	NUP	N
	190	36	2.1	2.1	201	241	20 500	24 600	3 600	4 300	NU221	NJ	NUP	N
	225	49	3	3	320	360	32 500	36 500	3 100	3 700	NU321	NJ	NUP	N
110	170	28	2	1.1	131	174	13 400	17 700	4 100	4 800	NU1022	NJ	NUP	N
	200	38	2.1	2.1	240	290	24 500	29 500	3 400	4 000	NU222	NJ	NUP	N
	200	38	2.1	2.1	293	365	29 800	37 000	3 100	3 700	NU222E	NJ	NUP	—
	200	53	2.1	2.1	320	415	32 500	42 000	3 100	3 700	NU2222	NJ	NUP	N
	200	53	2.1	2.1	385	515	39 000	52 500	2 800	3 300	NU2222E	NJ	NUP	—
	240	50	3	3	360	400	36 500	41 000	3 000	3 500	NU322	NJ	NUP	N
	240	50	3	3	450	525	46 000	53 500	2 700	3 100	NU322E	NJ	NUP	—
	240	80	3	3	605	790	61 500	80 500	2 600	3 100	NU2322	NJ	NUP	N
	240	80	3	3	675	880	69 000	89 500	2 400	2 800	NU2322E	NJ	NUP	—
120	180	28	2	1.1	139	191	14 100	19 500	3 800	4 400	NU1024	NJ	NUP	N
	215	40	2.1	2.1	260	320	26 500	32 500	3 200	3 700	NU224	NJ	NUP	N
	215	40	2.1	2.1	335	420	34 000	43 000	2 900	3 400	NU224E	NJ	NUP	—
	215	58	2.1	2.1	350	460	35 500	47 000	2 900	3 400	NU2224	NJ	NUP	N
	215	58	2.1	2.1	450	620	46 000	63 000	2 600	3 000	NU2224E	NJ	NUP	—
	260	55	3	3	450	510	46 000	52 000	2 700	3 200	NU324	NJ	NUP	N

1) This value achieved with machined cages; when pressed cages are used, 80% of this value is acceptable.
 2) Production switched to E type only for bearing number for which there is no standard form.
 3) Minimal allowable dimension for chamfer dimension r or r₁.

Cylindrical Roller Bearings

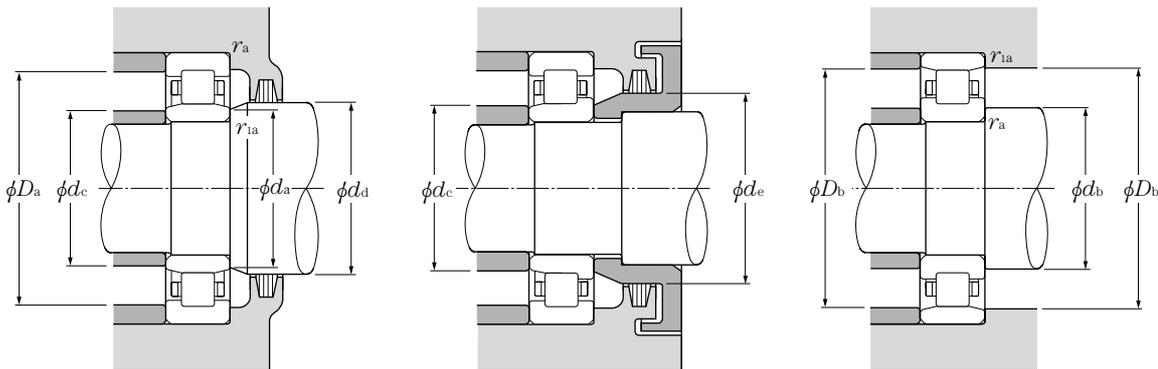

Dynamic equivalent radial load

$$P_r = F_r$$

Static equivalent radial load

$$P_{or} = F_r$$

type	Dimensions			Abutment and fillet dimensions										Mass	
	F_w	E_w	J	d_a min	d_b min	d_c max	d_d min	d_e min	D_a max	D_b max	D_b min ⁴⁾	r_{as} max	r_{ias} max	type NU (approx.)	type N
—	113.5	151.5	121	106	106	111	116	123	159	159	155	2	2	3.79	3.71
—	112.5	—	121	106	—	111	116	123	159	—	—	2	2	4.14	—
NF	121.5	173.5	132	108	108	119	124	134	187	187	178	2.5	2.5	6.13	5.99
—	121.5	—	132.7	108	—	119	124	134	187	—	—	2.5	2.5	6.62	—
—	121.5	173.5	132	108	108	119	124	134	187	187	178	2.5	2.5	9.2	9.02
—	121.5	—	132.7	108	—	119	124	134	187	—	—	2.5	2.5	9.8	—
—	113	137	117.8	106.5	108	111	116	119	142	143.5	139	1.5	1	1.45	1.43
NF	120	160	128	111	111	117	122	130	169	169	164	2	2	3.33	3.26
—	119	—	128	111	—	117	122	130	169	—	—	2	2	3.66	—
—	120	160	128	111	111	117	122	130	169	169	164	2	2	4.57	4.48
—	119	—	128	111	—	117	122	130	169	—	—	2	2	5.01	—
NF	129.5	185.5	140.5	113	113	125	132	143	202	202	190	2.5	2.5	7.49	7.32
—	127.5	—	140.3	113	—	125	132	143	202	—	—	2.5	2.5	8.57	—
—	129.5	185.5	140.5	113	113	125	132	143	202	202	190	2.5	2.5	11.7	11.5
—	127.5	—	140.3	113	—	125	132	143	202	—	—	2.5	2.5	12.8	—
—	119.5	145.5	124.7	111.5	114	118	122	126	151	153.5	147.5	2	1	1.84	1.81
NF	126.8	168.8	135	116	116	124	129	137	179	179	173	2	2	3.95	3.87
NF	135	195	147	118	118	132	137	149	212	212	199	2.5	2.5	8.53	8.33
—	125	155	131	116.5	119	124	128	132	161	163.5	157	2	1	2.33	2.3
NF	132.5	178.5	141.5	121	121	130	135	144	189	189	182	2	2	4.63	4.54
—	132.5	—	142.1	121	—	130	135	144	189	—	—	2	2	4.27	—
—	132.5	178.5	141.5	121	121	130	135	144	189	189	182	2	2	6.56	6.43
—	132.5	—	142.1	121	—	130	135	144	189	—	—	2	2	7.4	—
NF	143	207	155.5	123	123	140	145	158	227	227	211	2.5	2.5	10	9.77
—	143	—	156.6	123	—	140	145	158	227	—	—	2.5	2.5	11.1	—
—	143	207	155.5	123	123	140	145	158	227	227	211	2.5	2.5	17.1	16.8
—	143	—	156.6	123	—	140	145	158	227	—	—	2.5	2.5	19.4	—
—	135	165	141	126.5	129	134	138	142	171	173.5	167	2	1	2.44	2.4
NF	143.5	191.5	153	131	131	141	146	156	204	204	196	2	2	5.57	5.46
—	143.5	—	153.9	131	—	141	146	156	204	—	—	2	2	5.97	—
—	143.5	191.5	153	131	131	141	146	156	204	204	196	2	2	8.19	8.03
—	143.5	—	153.9	131	—	141	146	156	204	—	—	2	2	9.18	—
NF	154	226	168.5	133	133	151	156	171	247	247	230	2.5	2.5	12.8	12.5

4) Does not apply to side of the outer ring rib of type **NF** bearings.

Cylindrical Roller Bearings

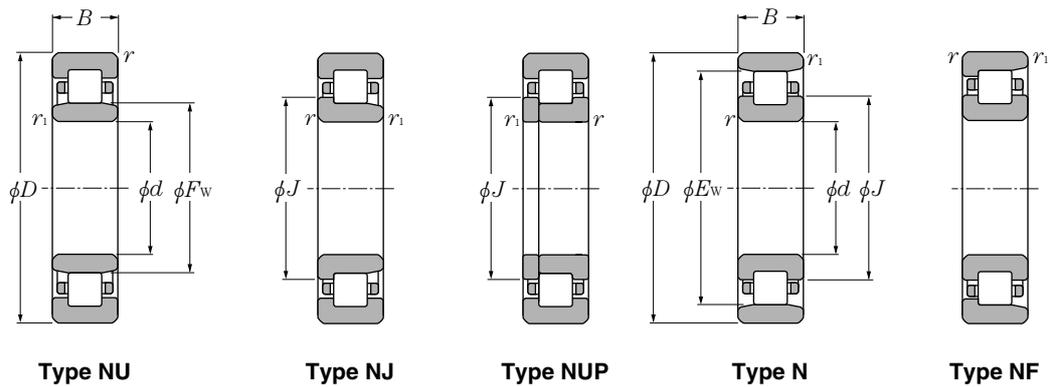

d 120 ~ 160mm

d	Boundary dimensions				Basic load ratings				Limiting speeds ¹⁾		Bearing numbers ²⁾			
	D	B	mm		dynamic	static	dynamic	static	min ⁻¹		type	type	type	type
	mm	mm	$r_{s \min}^{(3)}$	$r_{1s \min}^{(3)}$	kN	C _{or}	kgf	C _{or}	grease	oil	NU	NJ	NUP	N
120	260	55	3	3	530	610	54 000	62 000	2 400	2 800	NU324E	NJ	NUP	—
	260	86	3	3	710	920	72 500	93 500	2 400	2 800	NU2324	NJ	NUP	N
	260	86	3	3	795	1 030	81 000	105 000	2 200	2 500	NU2324E	NJ	NUP	—
130	200	33	2	1.1	172	238	17 500	24 200	3 400	4 000	NU1026	NJ	NUP	N
	230	40	3	3	270	340	27 600	35 000	2 900	3 400	NU226	NJ	NUP	N
	230	40	3	3	365	455	37 000	46 000	2 600	3 100	NU226E	NJ	NUP	—
	230	64	3	3	380	530	38 500	54 000	2 600	3 100	NU2226	NJ	NUP	N
	230	64	3	3	530	735	54 000	75 000	2 300	2 700	NU2226E	NJ	NUP	—
	280	58	4	4	560	665	57 000	68 000	2 500	2 900	NU326	NJ	NUP	N
	280	58	4	4	615	735	63 000	75 000	2 200	2 600	NU326E	NJ	NUP	—
	280	93	4	4	840	1 130	85 500	115 000	2 200	2 600	NU2326	NJ	NUP	N
140	210	33	2	1.1	176	250	17 900	25 500	3 200	3 800	NU1028	NJ	NUP	N
	250	42	3	3	310	400	31 500	40 500	2 700	3 100	NU228	NJ	NUP	N
	250	42	3	3	395	515	40 000	52 500	2 400	2 800	NU228E	NJ	NUP	—
	250	68	3	3	445	635	45 500	64 500	2 400	2 800	NU2228	NJ	NUP	N
	250	68	3	3	575	835	58 500	85 000	2 100	2 500	NU2228E	NJ	NUP	—
	300	62	4	4	615	745	63 000	76 000	2 300	2 700	NU328	NJ	NUP	N
	300	62	4	4	665	795	67 500	81 500	2 100	2 400	NU328E	NJ	NUP	—
	300	102	4	4	920	1 250	94 000	127 000	2 000	2 300	NU2328	NJ	NUP	N
150	225	35	2.1	1.5	202	294	20 600	29 900	3 000	3 500	NU1030	NJ	NUP	N
	270	45	3	3	345	435	35 000	44 500	2 500	2 900	NU230	NJ	NUP	N
	270	45	3	3	450	595	45 500	60 500	2 200	2 600	NU230E	NJ	NUP	—
	270	73	3	3	500	710	51 000	72 500	2 200	2 600	NU2230	NJ	NUP	N
	270	73	3	3	660	980	67 500	100 000	2 000	2 400	NU2230E	NJ	NUP	—
	320	65	4	4	665	805	67 500	82 500	2 100	2 500	NU330	NJ	NUP	N
	320	65	4	4	760	920	77 500	94 000	1 900	2 300	NU330E	NJ	NUP	—
	320	108	4	4	1 020	1 400	104 000	143 000	1 900	2 200	NU2330	NJ	NUP	N
160	240	38	2.1	1.5	238	340	24 200	35 000	2 800	3 300	NU1032	NJ	NUP	N
	290	48	3	3	430	570	43 500	58 000	2 300	2 700	NU232	NJ	NUP	N
	290	48	3	3	500	665	51 000	68 000	2 100	2 400	NU232E	NJ	NUP	—

1) This value achieved with machined cages; when pressed cages are used, 80% of this value is acceptable.
 2) Production switched to E type only for bearing number for which there is no standard form.
 3) Minimal allowable dimension for chamfer dimension r or r_1 .

Cylindrical Roller Bearings

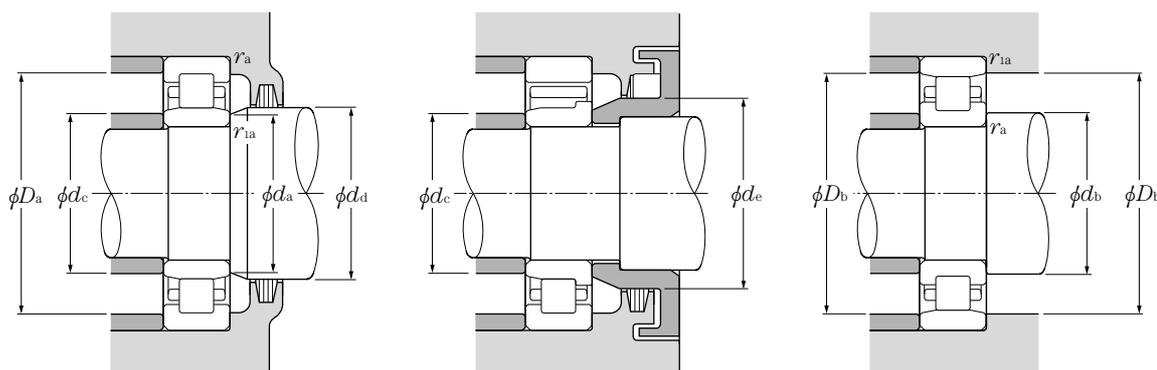

Dynamic equivalent radial load

$$P_r = F_r$$

Static equivalent radial load

$$P_{Or} = F_r$$

type	Dimensions			Abutment and fillet dimensions										Mass	
	F_w	E_w	J	d_a min	d_b min	d_c max	d_a min	d_e min	D_a max	D_b max	D_b min ⁴⁾	r_{as} max	r_{1as} max	type NU (approx.)	type N
—	154	—	169.2	133	—	151	156	171	247	—	—	2.5	2.5	13.9	—
—	154	226	168.5	133	133	151	156	171	247	247	230	2.5	2.5	21.5	21.1
—	154	—	169.2	133	—	151	156	171	247	—	—	2.5	2.5	26.1	—
—	148	182	154.8	136.5	139	146	151	156	191	193.5	184	2	1	3.69	3.63
NF	156	204	165.5	143	143	151	158	168	217	217	208	2.5	2.5	6.3	6.17
—	153.5	—	164.7	143	—	151	158	168	217	—	—	2.5	2.5	6.9	—
—	156	204	165.5	143	143	151	158	168	217	217	208	2.5	2.5	10.2	10
—	153.5	—	164.7	143	—	151	158	168	217	—	—	2.5	2.5	11.8	—
NF	167	243	182	146	146	164	169	184	264	264	247	3	3	17.4	17
—	167	—	183	146	—	164	169	184	264	—	—	3	3	19.4	—
—	167	243	182	146	146	164	169	184	264	264	247	3	3	26.9	26.4
—	167	—	183	146	—	164	169	184	264	—	—	3	3	30.9	—
—	158	192	164.8	146.5	149	156	161	166	201	203.5	194	2	1	4.05	3.98
NF	169	221	179.5	153	153	166	171	182	237	237	225	2.5	2.5	7.88	7.72
—	169	—	180.2	153	—	166	171	182	237	—	—	2.5	2.5	8.73	—
—	169	221	179.5	153	153	166	171	182	237	237	225	2.5	2.5	12.9	12.6
—	169	—	180.2	153	—	166	171	182	237	—	—	2.5	2.5	15.8	—
NF	180	260	196	156	156	176	182	198	284	284	265	3	3	21.2	20.7
—	180	—	196.8	156	—	176	182	198	284	—	—	3	3	23.2	—
—	180	260	196	156	156	176	182	198	284	284	265	3	3	33.8	33.1
—	180	—	196.8	156	—	176	182	198	284	—	—	3	3	38.7	—
—	169.5	205.5	176.7	158	161	167	173	178	214	217	207.5	2	1.5	4.77	4.7
NF	182	238	193	163	163	179	184	196	257	257	242	2.5	2.5	9.92	9.72
—	182	—	194	163	—	179	184	196	257	—	—	2.5	2.5	11	—
—	182	238	193	163	163	179	184	196	257	257	242	2.5	2.5	16.3	16
—	182	—	194	163	—	179	184	196	257	—	—	2.5	2.5	19.7	—
NF	193	277	210	166	166	190	195	213	304	304	282	3	3	25.3	24.7
—	193	—	211	166	—	190	195	213	304	—	—	3	3	28.4	—
—	193	277	210	166	166	190	195	213	304	304	282	3	3	40.6	39.8
—	193	—	211	166	—	190	195	213	304	—	—	3	3	47.2	—
—	180	220	188	168	171	178	184	189	229	232	222	2	1.5	5.9	5.81
NF	195	255	207	173	173	192	197	210	277	277	259	2.5	2.5	13.7	13.4
—	195	—	207.8	173	—	192	197	210	277	—	—	2.5	2.5	15.6	—

4) Does not apply to side of the outer ring rib of type **NF** bearings.

Cylindrical Roller Bearings

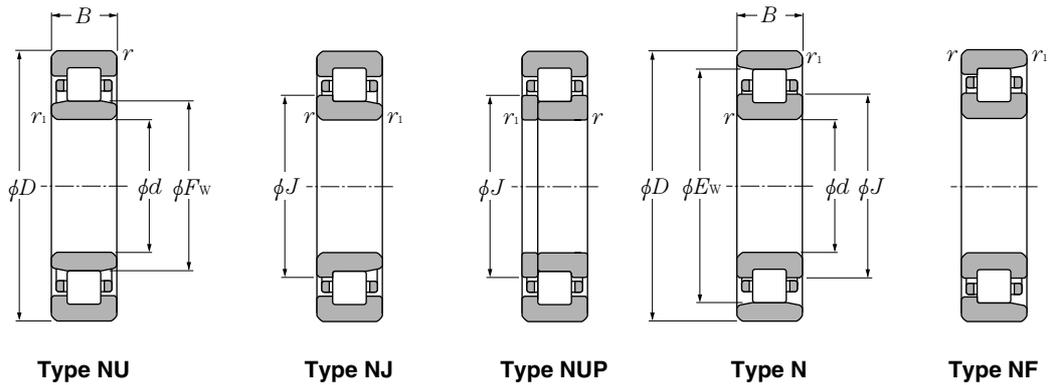

d 160 ~ 200mm

d	Boundary dimensions				Basic load ratings				Limiting speeds ¹⁾		Bearing numbers ²⁾			
	D	B	$r_{1s \min}^{(3)}$		dynamic	static	dynamic	static	min ⁻¹		type	type	type	type
	mm	mm	$r_{1s \min}^{(3)}$	$r_{1s \min}^{(3)}$	kN	C _{or}	kgf	C _{or}	grease	oil	NU	NJ	NUP	N
160	290	80	3	3	630	940	64 500	96 000	2 100	2 400	NU2232	NJ	NUP	N
	290	80	3	3	810	1 190	82 500	121 000	1 900	2 200	NU2232E	NJ	NUP	—
	340	68	4	4	700	875	71 000	89 500	2 000	2 300	NU332	NJ	NUP	N
	340	68	4	4	860	1 050	87 500	107 000	1 800	2 100	NU332E	NJ	NUP	—
	340	114	4	4	1 070	1 520	109 000	155 000	1 700	2 000	NU2332	NJ	NUP	N
	340	114	4	4	1 310	1 820	134 000	186 000	1 600	1 900	NU2332E	NJ	NUP	—
170	260	42	2.1	2.1	278	400	28 300	41 000	2 600	3 000	NU1034	NJ	NUP	N
	310	52	4	4	475	635	48 500	65 000	2 200	2 500	NU234	NJ	NUP	N
	310	52	4	4	605	800	61 500	81 500	2 000	2 300	NU234E	NJ	NUP	—
	310	86	4	4	715	1 080	73 000	110 000	2 000	2 300	NU2234	NJ	NUP	N
	310	86	4	4	965	1 410	98 500	144 000	1 800	2 100	NU2234E	NJ	NUP	—
	360	72	4	4	795	1 010	81 500	103 000	1 800	2 200	NU334	NJ	NUP	N
360	120	4	4	1 220	1 750	125 000	179 000	1 600	1 900	NU2334	NJ	NUP	N	
180	280	46	2.1	2.1	340	485	35 000	49 500	2 400	2 900	NU1036	NJ	NUP	N
	320	52	4	4	495	675	50 500	69 000	2 000	2 400	NU236	NJ	NUP	N
	320	52	4	4	625	850	64 000	87 000	1 800	2 200	NU236E	NJ	NUP	—
	320	86	4	4	745	1 140	76 000	117 000	1 800	2 200	NU2236	NJ	NUP	N
	320	86	4	4	1 010	1 510	103 000	154 000	1 600	1 900	NU2236E	NJ	NUP	—
	380	75	4	4	905	1 150	92 000	118 000	1 700	2 000	NU336	NJ	NUP	N
	380	126	4	4	1 380	1 990	141 000	203 000	1 500	1 800	NU2336	NJ	NUP	N
190	290	46	2.1	2.1	350	510	36 000	52 000	2 300	2 700	NU1038	NJ	NUP	N
	340	55	4	4	555	770	56 500	78 500	1 900	2 200	NU238	NJ	NUP	N
	340	55	4	4	695	955	71 000	97 500	1 700	2 000	NU238E	NJ	NUP	—
	340	92	4	4	830	1 290	84 500	131 000	1 700	2 000	NU2238	NJ	NUP	N
	340	92	4	4	1 100	1 670	113 000	170 000	1 500	1 800	NU2238E	NJ	NUP	—
	400	78	5	5	975	1 260	99 500	129 000	1 600	1 900	NU338	NJ	NUP	N
400	132	5	5	1 520	2 220	155 000	226 000	1 400	1 700	NU2338	NJ	NUP	N	
200	310	51	2.1	2.1	390	580	40 000	59 500	2 200	2 600	NU1040	NJ	NUP	N
	360	58	4	4	620	865	63 500	88 500	1 800	2 100	NU240	NJ	NUP	N
	360	58	4	4	765	1 060	78 000	108 000	1 600	1 900	NU240E	NJ	NUP	—
	360	98	4	4	925	1 440	94 000	147 000	1 600	1 900	NU2240	NJ	NUP	N
	360	98	4	4	1 220	1 870	125 000	191 000	1 500	1 700	NU2240E	NJ	NUP	—
	420	80	5	5	975	1 270	99 500	130 000	1 500	1 800	NU340	NJ	NUP	N

1) This value achieved with machined cages; when pressed cages are used, 80% of this value is acceptable.
 2) Production switched to E type only for bearing number for which there is no standard form.
 3) Minimal allowable dimension for chamfer dimension r or r_1 .

Cylindrical Roller Bearings

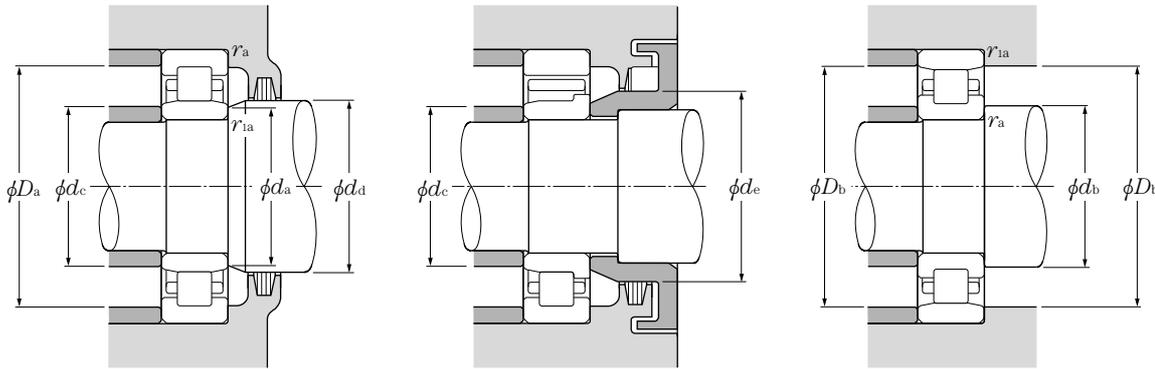

Dynamic equivalent radial load
 $P_r = F_r$

Static equivalent radial load
 $P_{Or} = F_r$

type	Dimensions			Abutment and fillet dimensions										Mass	
	F_w	E_w	J	d_a min	d_b min	d_c max	d_a min	d_e min	D_a max	D_b max	D_b min ⁴⁾	r_{as} max	r_{1as} max	type NU (approx.)	type N
—	195	255	207	173	173	192	197	210	277	277	259	2.5	2.5	22	21.6
—	193	—	206.6	173	—	192	197	210	277	—	—	2.5	2.5	25.1	—
NF	208	292	225	176	176	200	211	228	324	324	297	3	3	31.3	30.6
—	204	—	223.2	176	—	200	211	228	324	—	—	3	3	34	—
—	208	292	225	176	176	200	211	228	324	324	297	3	3	50.5	49.5
—	204	—	223.2	176	—	200	211	228	324	—	—	3	3	56	—
—	193	237	201.8	181	181	190	197	203	249	249	239	2	2	7.88	7.76
NF	208	272	220.5	186	186	204	211	223	294	294	277	3	3	17	16.7
—	207	—	221.4	186	—	204	211	223	294	—	—	3	3	19.6	—
—	208	272	220.5	186	186	204	211	223	294	294	277	3	3	27.2	26.7
—	205	—	220.2	186	—	204	211	223	294	—	—	3	3	31	—
NF	220	310	238	186	186	216	223	241	344	344	315	3	3	37	36.1
—	220	310	238	186	186	216	223	241	344	344	315	3	3	59.5	58.3
—	205	255	215	191	191	203	209	216	269	269	257	2	2	10.3	10.1
NF	218	282	230.5	196	196	214	221	233	304	304	287	3	3	17.7	17.3
—	217	—	231.4	196	—	214	221	233	304	—	—	3	3	20.4	—
—	218	282	230.5	196	196	214	221	233	304	304	287	3	3	28.4	27.8
—	215	—	230.2	196	—	214	221	233	304	—	—	3	3	31.9	—
NF	232	328	252	196	196	227	235	255	364	364	333	3	3	44.2	43.2
—	232	328	252	196	196	227	235	255	364	364	333	3	3	69.5	68.1
—	215	265	225	201	201	213	219	226	279	279	267	2	2	10.7	10.5
NF	231	299	244.5	206	206	227	234	247	324	324	304	3	3	21.3	20.8
—	230	—	245.2	206	—	227	234	247	324	—	—	3	3	24.2	—
—	231	299	244.5	206	206	227	234	247	324	324	304	3	3	34.4	33.7
—	228	—	244	206	—	227	234	247	324	—	—	3	3	39.5	—
NF	245	345	265	210	210	240	248	268	380	380	351	4	4	49.4	48.3
—	245	345	265	210	210	240	248	268	380	380	351	4	4	80.5	78.9
—	229	281	239.4	211	211	226	233	241	299	299	283	2	2	13.9	13.7
NF	244	316	258	216	216	240	247	261	344	344	321	3	3	25.3	24.8
—	243	—	259	216	—	240	247	261	344	—	—	3	3	28.1	—
—	244	316	258	216	216	240	247	261	344	344	321	3	3	41.3	40.5
—	241	—	257.8	216	—	240	247	261	344	—	—	3	3	47.8	—
NF	260	360	280	220	220	254	263	283	400	400	366	4	4	55.8	54.5

4) Does not apply to side of the outer ring rib of type **NF** bearings.

Cylindrical Roller Bearings

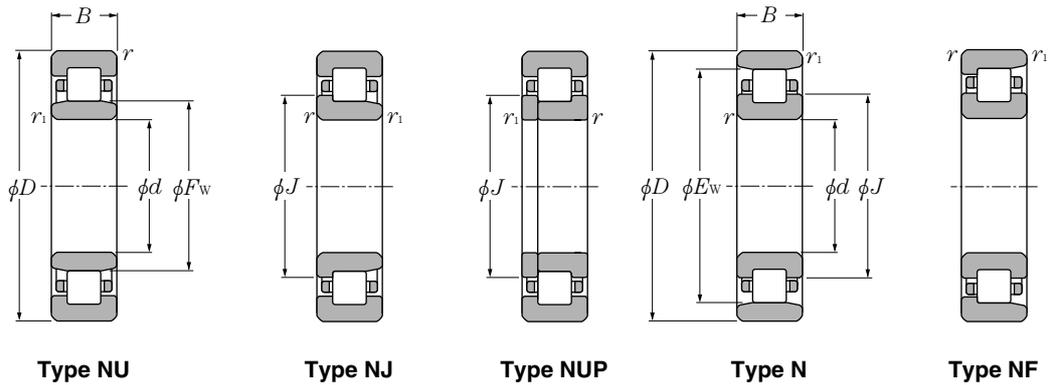

d 200 ~ 360mm

d	Boundary dimensions				Basic load ratings				Limiting speeds ¹⁾		Bearing numbers ²⁾			
	D	B	mm		dynamic		static		min ⁻¹		type	type	type	type
	mm	mm	$r_{s \min}^{(3)}$	$r_{1s \min}^{(3)}$	kN	kN	kgf	kgf	grease	oil	NU	NJ	NUP	N
200	420	138	5	5	1 510	2 240	154 000	229 000	1 400	1 600	NU2340	NJ	NUP	N
	340	56	3	3	500	750	51 000	76 500	2 000	2 300	NU1044	NJ	NUP	N
220	400	65	4	4	760	1 080	77 500	110 000	1 600	1 900	NU244	NJ	NUP	N
	400	108	4	4	1 140	1 810	116 000	184 000	1 500	1 700	NU2244	NJ	NUP	N
	460	88	5	5	1 190	1 570	122 000	161 000	1 400	1 600	NU344	NJ	NUP	N
	460	145	5	5	1 780	2 620	181 000	268 000	1 200	1 400	NU2344	NJ	NUP	N
240	360	56	3	3	530	820	54 000	83 500	1 800	2 100	NU1048	NJ	NUP	N
	440	72	4	4	935	1 340	95 500	136 000	1 500	1 700	NU248	NJ	NUP	N
	440	120	4	4	1 440	2 320	146 000	236 000	1 300	1 600	NU2248	NJ	NUP	N
	500	95	5	5	1 430	1 950	146 000	198 000	1 300	1 500	NU348	NJ	NUP	N
	500	155	5	5	2 100	3 200	214 000	325 000	1 100	1 300	NU2348	NJ	NUP	N
260	400	65	4	4	645	1 000	65 500	102 000	1 600	1 900	NU1052	NJ	NUP	N
	480	80	5	5	1 150	1 660	117 000	170 000	1 300	1 600	NU252	NJ	NUP	N
	480	130	5	5	1 780	2 930	182 000	299 000	1 200	1 400	NU2252	NJ	NUP	N
	540	102	6	6	1 620	2 230	165 000	228 000	1 200	1 400	NU352	NJ	NUP	N
	540	165	6	6	2 340	3 600	239 000	365 000	1 000	1 200	NU2352	NJ	NUP	N
280	420	65	4	4	660	1 050	67 000	107 000	1 500	1 800	NU1056	NJ	NUP	N
	500	80	5	5	1 190	1 760	121 000	180 000	1 200	1 400	NU256	NJ	NUP	N
	500	130	5	5	1 840	3 100	188 000	315 000	1 100	1 300	NU2256	NJ	NUP	N
	580	108	6	6	1 820	2 540	185 000	259 000	1 100	1 200	NU356	NJ	NUP	N
	580	175	6	6	2 700	4 250	275 000	430 000	920	1 100	NU2356	NJ	NUP	N
300	460	74	4	4	855	1 340	87 000	137 000	1 400	1 600	NU1060	NJ	NUP	N
	540	85	5	5	1 400	2 070	143 000	211 000	1 100	1 300	NU260	NJ	NUP	N
	540	140	5	5	2 180	3 650	223 000	370 000	1 000	1 200	NU2260	NJ	NUP	N
320	480	74	4	4	875	1 410	89 500	143 000	1 300	1 500	NU1064	NJ	NUP	N
	580	92	5	5	1 600	2 390	164 000	244 000	1 000	1 200	NU264	NJ	NUP	N
	580	150	5	5	2 550	4 350	260 000	445 000	950	1 100	NU2264	NJ	NUP	N
340	520	82	5	5	1 050	1 670	107 000	170 000	1 200	1 400	NU1068	NJ	NUP	N
360	540	82	5	5	1 080	1 750	110 000	179 000	1 100	1 300	NU1072	NJ	NUP	N

1) This value achieved with machined cages; when pressed cages are used, 80% of this value is acceptable.
 2) Production switched to E type only for bearing number for which there is no standard form.
 3) Minimal allowable dimension for chamfer dimension r or r_1 .

Cylindrical Roller Bearings

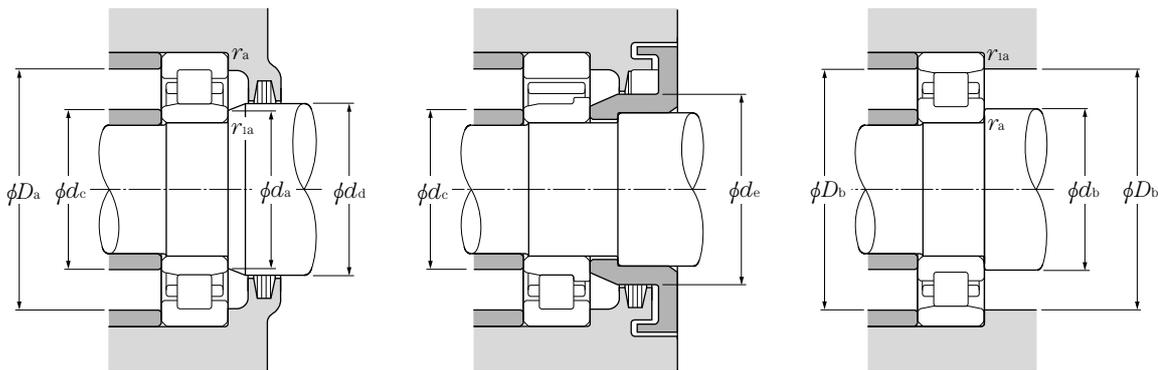

Dynamic equivalent radial load
 $P_r = F_r$
Static equivalent radial load
 $P_{Or} = F_r$

type	Dimensions			Abutment and fillet dimensions										Mass	
	F_w	E_w	J	d_a min	d_b min	d_c max	d_a min	d_e min	D_a max	D_b max	D_b min ⁴⁾	r_{as} max	r_{1as} max	type NU (approx.)	type N
—	260	360	280	220	220	254	263	283	400	400	366	4	4	92.6	90.7
—	250	310	262	233	233	248	254	264	327	327	313	2.5	2.5	18.2	17.9
NF	270	350	286	236	236	266	273	289	384	384	355	3	3	37.7	37
—	270	350	286	236	236	266	273	289	384	384	355	3	3	59	57.8
NF	284	396	307	240	240	279	287	307	440	440	402	4	4	73.4	71.7
—	284	396	307	240	240	279	287	307	440	440	402	4	4	116	114
—	270	330	282	253	253	268	275	284	347	347	333	2.5	2.5	19.6	19.3
NF	295	385	313	256	256	293	298	316	424	424	390	3	3	50.2	49.2
—	295	385	313	256	256	293	298	316	424	424	390	3	3	80	78.4
NF	310	430	335	260	260	305	313	333	480	480	436	4	4	93.4	91.3
—	310	430	335	260	260	305	313	333	480	480	436	4	4	147	144
—	296	364	309.6	276	276	292	300	312	384	384	367	3	3	29.1	28.7
NF	320	420	340	280	280	318	323	343	460	460	426	4	4	66.9	65.6
—	320	420	340	280	280	318	323	343	460	460	426	4	4	104	102
NF	336	464	362	284	284	331	339	359	516	516	471	5	5	117	114
—	336	464	362	284	284	331	339	359	516	516	471	5	5	182	178
—	316	384	329.6	296	296	312	320	332	404	404	387	3	3	30.9	30.4
NF	340	440	360	300	300	336	343	365	480	480	446	4	4	70.8	69.4
—	340	440	360	300	300	336	343	365	480	480	446	4	4	109	107
NF	362	498	390	304	304	356	366	386	556	556	505	5	5	142	139
—	362	498	390	304	304	356	366	386	556	556	505	5	5	222	218
—	340	420	356	316	316	336	344	358	444	444	423	3	3	43.6	42.9
NF	364	476	387	320	320	361	368	392	520	520	482	4	4	88.2	86.4
—	364	476	387	320	320	361	368	392	520	520	482	4	4	138	135
—	360	440	376	336	336	356	364	378	464	464	443	3	3	46	45.3
NF	390	510	415	340	340	386	393	419	560	560	516	4	4	111	109
—	390	510	415	340	340	386	393	419	560	560	516	4	4	172	168
—	385	475	403	360	360	381	390	405	500	500	479	4	4	61.8	60.8
—	405	495	423	380	380	401	410	425	520	520	499	4	4	64.7	63.7

4) Does not apply to side of the outer ring rib of type **NF** bearings.

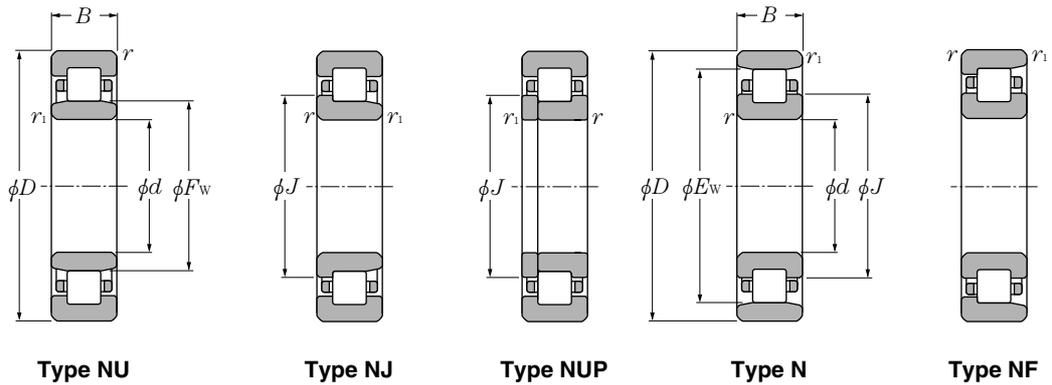

d 380 ~ 500mm

Boundary dimensions				Basic load ratings				Limiting speeds ¹⁾		Bearing numbers ²⁾				
d	D	mm B	r _{s min} ³⁾		dynamic	static	dynamic	static	min ⁻¹ grease	oil	type NU	type NJ	type NUP	type N
			r _{1s min} ³⁾	C _r	kN C _{or}	kgf C _r	C _{or}							
380	560	82	5	5	1 100	1 840	112 000	187 000	1 100	1 200	NU1076	NJ	NUP	N
400	600	90	5	5	1 320	2 190	134 000	223 000	990	1 200	NU1080	NJ	NUP	N
420	620	90	5	5	1 350	2 290	138 000	233 000	950	1 100	NU1084	NJ	NUP	N
440	650	94	6	6	1 430	2 430	146 000	248 000	900	1 100	NU1088	NJ	NUP	N
460	680	100	6	6	1 540	2 630	157 000	269 000	850	1 000	NU1092	NJ	NUP	N
480	700	100	6	6	1 580	2 750	161 000	280 000	810	960	NU1096	NJ	NUP	N
500	720	100	6	6	1 610	2 870	164 000	292 000	770	910	NU10/500	NJ	NUP	N

1) This value achieved with machined cages; when pressed cages are used, 80% of this value is acceptable.
 2) Production switched to E type only for bearing number for which there is no standard form.
 3) Minimal allowable dimension for chamfer dimension *r* or *r₁*.

Cylindrical Roller Bearings

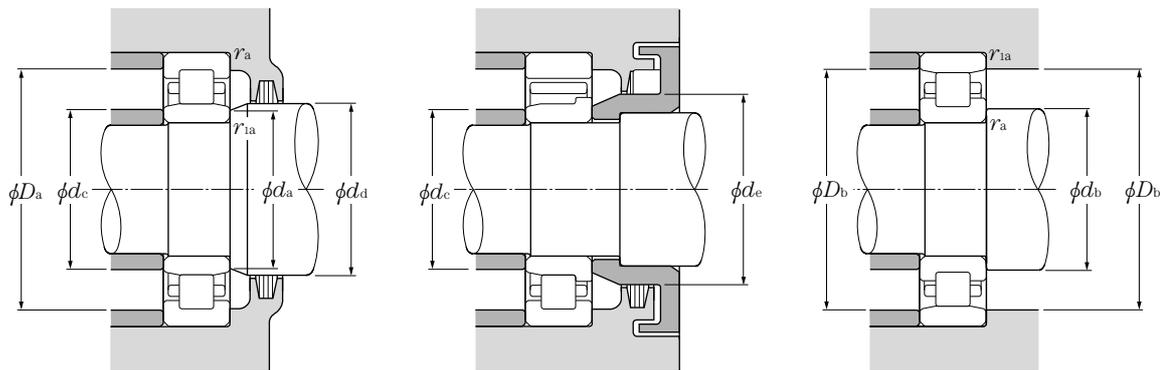

Dynamic equivalent radial load
 $P_r = F_r$
Static equivalent radial load
 $P_{Or} = F_r$

type NF	Dimensions			Abutment and fillet dimensions										Mass	
	F_w	E_w	J	d_a min	d_b min	d_c max	d_a min	d_e min	D_a max	D_b max	D_b min ⁴⁾	r_{as} max	r_{1as} max	type NU (approx.)	type N
—	425	515	443	400	400	421	430	445	540	540	519	4	4	67.5	66.5
—	450	550	470	420	420	446	455	473	580	580	554	4	4	87.6	86.3
—	470	570	490	440	440	466	475	493	600	600	574	4	4	91	89.6
—	493	597	513.8	464	464	488	499	517	626	626	602	5	5	105	103
—	516	624	537.6	484	484	511	522	541	656	656	629	5	5	122	120
—	536	644	557.6	504	504	531	542	561	676	676	649	5	5	126	124
—	556	664	577.6	524	524	551	562	581	696	696	669	5	5	130	128

4) Does not apply to side of the outer ring rib of type NF bearings.

L Type Loose Rib

L type collar ring

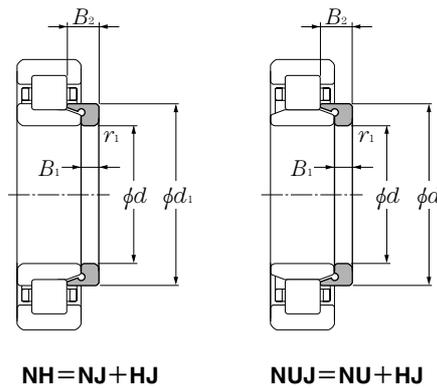

d 20 ~ 60mm

Dimensions						Bearing numbers	Mass kg (approx.)	Dimensions					Bearing numbers	Mass kg (approx.)
d	d ₁	B ₁	B ₂	r _{1s min} ¹⁾	d			d ₁	B ₁	B ₂	r _{1s min} ¹⁾			
20	29.9	3	6.75	0.6	HJ204	0.012	40	54.2	5	9	1.1	HJ208	0.046	
	29.5	3	5.5	0.6	HJ204E	0.009		53.9	5	8.5	1.1	HJ208E	0.042	
	29.9	3	7.5	0.6	HJ2204	0.013		54.2	5	9.5	1.1	HJ2208	0.047	
	29.5	3	6.5	0.6	HJ2204E	0.01		53.9	5	9	1.1	HJ2208E	0.045	
	31.8	4	7.5	0.6	HJ304	0.017		58.4	7	12.5	1.5	HJ308	0.083	
	31.1	4	6.5	0.6	HJ304E	0.014		57.6	7	11	1.5	HJ308E	0.07	
	31.8	4	8.5	0.6	HJ2304	0.018		58.4	7	14.5	1.5	HJ2308	0.09	
	31.1	4	7.5	0.6	HJ2304E	0.015		57.6	7	12.5	1.5	HJ2308E	0.08	
25	34.8	3	7.25	0.6	HJ205	0.015	45	64.8	8	13	2	HJ408	0.14	
	34.5	3	6	0.6	HJ205E	0.012		59	5	9.5	1.1	* HJ209	0.053	
	34.8	3	7.5	0.6	HJ2205	0.015		58.9	5	8.5	1.1	HJ209E	0.047	
	34.5	3	6.5	0.6	HJ2205E	0.013		58.9	5	9	1.1	HJ2209E	0.05	
	39	4	8	1.1	HJ305	0.025		64	7	12.5	1.5	HJ309	0.099	
	38	4	7	1.1	HJ305E	0.021		64.5	7	11.5	1.5	HJ309E	0.093	
	39	4	9	1.1	HJ2305	0.027		64	7	15	1.5	HJ2309	0.109	
	38	4	8	1.1	HJ2305E	0.024		64.5	7	13	1.5	HJ2309E	0.103	
43.6	6	10.5	1.5	HJ405	0.057	71.8	8	13.5	2	HJ409	0.175			
30	41.7	4	8.25	0.6	HJ206	0.025	50	64.6	5	10	1.1	HJ210	0.063	
	41.1	4	7	0.6	HJ206E	0.017		63.9	5	9	1.1	* HJ210E	0.055	
	41.7	4	8.5	0.6	HJ2206	0.025		64.6	5	9.5	1.1	HJ2210	0.061	
	41.1	4	7.5	0.6	HJ2206E	0.02		71	8	14	2	HJ310	0.142	
	45.9	5	9.5	1.1	HJ306	0.039		71.4	8	13	2	HJ310E	0.134	
	44.9	5	8.5	1.1	HJ306E	0.035		71	8	17	2	HJ2310	0.157	
	45.9	5	11.5	1.1	HJ2306	0.043		71.4	8	14.5	2	HJ2310E	0.15	
	44.9	5	9.5	1.1	HJ2306E	0.035		78.8	9	14.5	2.1	HJ410	0.23	
50.5	7	11.5	1.5	HJ406	0.08	55	70.8	6	11	1.1	* HJ211	0.084		
35	47.6	4	8	0.6	HJ207		0.03	70.8	6	9.5	1.1	HJ211E	0.072	
	48	4	7	0.6	HJ207E		0.027	70.8	6	10	1.1	HJ2211E	0.076	
	47.6	4	8.5	0.6	HJ2207		0.031	77.2	9	15	2	HJ311	0.182	
	48	4	8.5	0.6	HJ2207E		0.031	77.7	9	14	2	HJ311E	0.168	
	50.8	6	11	1.1	HJ307		0.056	77.2	9	18.5	2	HJ2311	0.203	
	51	6	9.5	1.1	HJ307E		0.048	77.7	9	15.5	2	HJ2311E	0.185	
	50.8	6	14	1.1	HJ2307		0.064	85.2	10	16.5	2.1	HJ411	0.29	
	51	6	11	1.1	HJ2307E	0.055	60	78.4	6	11	1.5	* HJ212	0.108	
59	8	13	1.5	HJ407	0.12	77.6		6	10	1.5	* HJ212E	0.094		

1) Minimal allowable dimension for chamfer dimension r. Note: 1. This L type collar ring is used with NU type cylindrical roller bearings; in duplex arrangements with NJ or NU type bearing numbers, they become NH type and NUJ type respectively. For bearing dimensions, allowable rotations, and mass, please refer to pages B-80 to B-84. 2. * indicates L type collar rings that can also be used with dimension series 22 bearings.

L Type Loose Rib

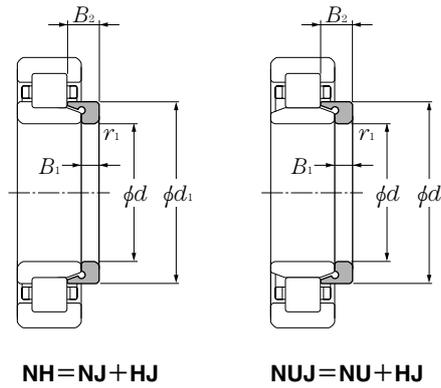

d 60 ~ 105mm

	Dimensions					Bearing numbers	Mass kg (approx.)
	mm						
d	d ₁	B ₁	B ₂	r _{1s min} ¹⁾			
60	84.2	9	15.5	2.1	HJ312	0.22	
	84.6	9	14.5	2.1	HJ312E	0.205	
	84.2	9	19	2.1	HJ2312	0.245	
	84.6	9	16	2.1	HJ2312E	0.23	
	91.8	10	16.5	2.1	HJ412	0.34	
65	84.8	6	11	1.5	HJ213	0.123	
	84.5	6	10	1.5	HJ213E	0.111	
	84.8	6	11.5	1.5	HJ2213	0.126	
	84.5	6	10.5	1.5	HJ2213E	0.118	
	91	10	17	2.1	HJ313	0.28	
	91	10	15.5	2.1	HJ313E	0.25	
	91	10	20	2.1	HJ2313	0.304	
	91	10	18	2.1	HJ2313E	0.29	
70	89.6	7	12.5	1.5	* HJ214	0.15	
	89.5	7	11	1.5	HJ214E	0.13	
	89.5	7	11.5	1.5	HJ2214E	0.138	
	98	10	17.5	2.1	HJ314	0.33	
	98	10	15.5	2.1	HJ314E	0.293	
	98	10	20.5	2.1	HJ2314	0.358	
	98	10	18.5	2.1	HJ2314E	0.35	
75	110.5	12	20	3	HJ414	0.605	
	94	7	12.5	1.5	* HJ215	0.156	
	94.5	7	11	1.5	HJ215E	0.141	
	94.5	7	11.5	1.5	HJ2215E	0.164	
	104.2	11	18.5	2.1	HJ315	0.4	
	104.6	11	16.5	2.1	HJ315E	0.35	
	104.2	11	21.5	2.1	HJ2315	0.432	
	104.6	11	19.5	2.1	HJ2315E	0.41	
80	116.0	13	21.5	3	HJ415	0.71	
	101.2	8	13.5	2	* HJ216	0.207	
	101.7	8	12.5	2	* HJ216E	0.193	
	111.8	11	19.5	2.1	HJ316	0.47	
	111	11	17	2.1	HJ316E	0.405	

	Dimensions					Bearing numbers	Mass kg (approx.)
	mm						
d	d ₁	B ₁	B ₂	r _{1s min} ¹⁾			
80	111	11	20	2.1	HJ2316E	0.45	
	122	13	22	3	HJ416	0.78	
85	108.2	8	14	2	* HJ217	0.25	
	107.7	8	12.5	2	HJ217E	0.21	
	107.7	8	13	2	HJ2217E	0.216	
	117.5	12	20.5	3	HJ317	0.56	
	118.4	12	18.5	3	HJ317E	0.505	
	117.5	12	24	3	HJ2317	0.606	
90	118.4	12	22	3	HJ2317E	0.55	
	114.2	9	15	2	HJ218	0.305	
	114.6	9	14	2	HJ218E	0.272	
	114.2	9	16	2	HJ2218	0.315	
	114.6	9	15	2	HJ2218E	0.308	
	125	12	21	3	HJ318	0.63	
	124.7	12	18.5	3	HJ318E	0.548	
95	125	12	26	3	HJ2318	0.704	
	124.7	12	22	3	HJ2318E	0.69	
	121	9	15.5	2.1	HJ219	0.352	
	121	9	14.0	2.1	HJ219E	0.304	
	121	9	16.5	2.1	HJ2219	0.363	
	121	9	15.5	2.1	HJ2219E	0.335	
	132	13	22.5	3	HJ319	0.76	
100	132.7	13	20.5	3	HJ319E	0.7	
	132	13	26.5	3	HJ2319	0.826	
	132.7	13	24.5	3	HJ2319E	0.8	
	128	10	17	2.1	HJ220	0.444	
	128	10	15	2.1	HJ220E	0.38	
105	128	10	18	2.1	HJ2220	0.456	
	128	10	16	2.1	HJ2220E	0.385	
	140.5	13	22.5	3	HJ320	0.895	
	140.3	13	20.5	3	HJ320E	0.8	
	140.5	13	27.5	3	HJ2320	0.986	

1) Minimal allowable dimension for chamfer dimension r. Note: 1. This L type collar ring is used with NU type cylindrical roller bearings; in duplex arrangements with NJ or NU type bearing numbers, they become NH type and NUJ type respectively. For bearing dimensions, allowable rotations, and mass, please refer to pages B-84 to B-88. 2. " * " indicates L type collar rings that can also be used with dimension series 22 bearings.

L Type Loose Rib

L type collar ring

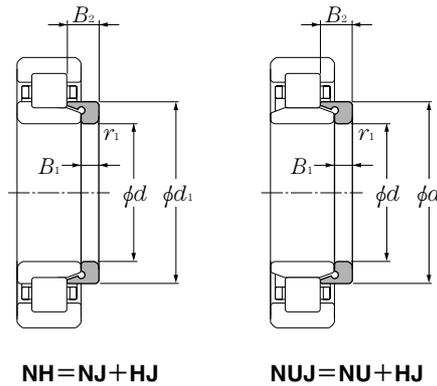

d 105 ~ 200mm

Dimensions						Bearing numbers	Mass kg (approx.)	Dimensions					Bearing numbers	Mass kg (approx.)
mm					mm									
d	d ₁	B ₁	B ₂	r _{1s min} ¹⁾		d	d ₁	B ₁	B ₂	r _{1s min} ¹⁾				
105	147.0	13	22.5	3	HJ321	0.97	150	194	12	19.5	3	HJ230E	1.18	
	141.5	11	18.5	2.1	HJ222	0.615		193	12	26.5	3	HJ2230E	1.39	
	142.1	11	17	2.1	HJ222E	0.553		194	12	24.5	3	HJ2230E	1.42	
	141.5	11	20.5	2.1	HJ2222	0.645		210	15	26.5	4	HJ330	2.37	
	142.1	11	19.5	2.1	HJ2222E	0.605		211	15	25	4	HJ330E	2.25	
110	155.5	14	23	3	HJ322	1.17	210	15	34	4	HJ2330	2.69		
	156.6	14	22	3	HJ322E	1.09	211	15	31.5	4	HJ2330E	2.6		
	155.5	14	28	3	HJ2322	1.28	160	207	12	21	3	HJ232	1.48	
	156.6	14	26.5	3	HJ2322E	1.25		207.8	12	20	3	HJ232E	1.34	
	120	153	11	19	2.1	HJ224		0.715	207	12	28	3	HJ2232	1.69
153.9		11	17	2.1	HJ224E	0.634		206.6	12	24.5	3	HJ2232E	1.61	
153		11	22	2.1	HJ2224	0.767		225	15	28	4	HJ332	2.75	
153.9		11	20	2.1	HJ2224E	0.705	223.2	15	25	4	HJ332E	2.4		
168.5		14	23.5	3	HJ324	1.4	225	15	37	4	HJ2332	3.16		
130	169.2	14	22.5	3	HJ324E	1.28	223.2	15	32	4	HJ2332E	2.85		
	168.5	14	28	3	HJ2324	1.53	170	220.5	12	22	4	HJ234	1.7	
	169.2	14	26	3	HJ2324E	1.42		221.4	12	20	4	HJ234E	1.51	
	165.5	11	19	3	HJ226	0.84		220.5	12	29	4	HJ2234	1.93	
	164.7	11	17	3	HJ226E	0.684		220.2	12	24	4	HJ2234E	1.82	
165.5	11	25	3	HJ2226	0.953	238		16	29.5	4	HJ334	3.25		
140	164.7	11	21	3	HJ2226E	0.831	238	16	38.5	4	HJ2334	3.71		
	182	14	24	4	HJ326	1.62	180	230.5	12	22	4	HJ236	1.8	
	183	14	23	4	HJ326E	1.53		231.4	12	20	4	HJ236E	1.7	
	182	14	29.5	4	HJ2326	1.8		230.5	12	29	4	HJ2236	2.04	
	183	14	28	4	HJ2326E	1.75		230.2	12	24	4	HJ2236E	1.91	
150	179.5	11	19	3	HJ228	1		252	17	30.5	4	HJ336	3.85	
	180.2	11	18	3	HJ228E	0.929	252	17	40	4	HJ2336	4.42		
	179.5	11	25	3	HJ2228	1.14	190	244.5	13	23.5	4	HJ238	2.2	
	180.2	11	23	3	HJ2228E	1.11		245.2	13	21.5	4	HJ238E	1.94	
	196	15	26	4	HJ328	1.93		244.5	13	31.5	4	HJ2238	2.52	
196.8	15	25	4	HJ328E	1.91	244		13	26.5	4	HJ2238E	2.38		
196	15	33.5	4	HJ2328	2.21	265		18	32	5	HJ338	4.45		
150	196.8	15	31	4	HJ2328E	2.3	265	18	41.5	5	HJ2338	5.05		
	193	12	20.5	3	HJ230	1.24	200	258	14	25	4	HJ240	2.6	

1) Minimal allowable dimension for chamfer dimension r. Note: 1. This L type collar ring is used with NU type cylindrical roller bearings; in duplex arrangements with NJ or NU type bearing numbers, they become NH type and NUJ type respectively. For bearing dimensions, allowable rotations, and mass, please refer to pages B-88 to B-94. 2. " * " indicates L type collar rings that can also be used with dimension series 22 bearings.

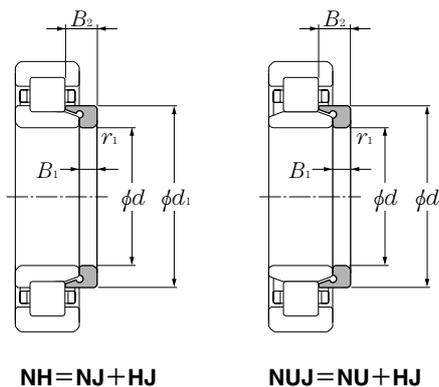

d 200 ~ 320mm

	Dimensions				Bearing numbers	Mass
	mm					
<i>d</i>	<i>d</i> ₁	<i>B</i> ₁	<i>B</i> ₂	<i>r</i> _{1s min} ¹⁾		(approx.)
200	259	14	23	4	HJ240E	2.35
	258	14	34	4	HJ2240	2.99
	257.8	14	28	4	HJ2240E	2.86
	280	18	33	5	HJ340	5
	280	18	44.5	5	HJ2340	5.76
220	286	15	27.5	4	HJ244	3.55
	307	20	36	5	HJ344	7.05
240	313	16	29.5	4	HJ248	4.65
	335	22	39.5	5	HJ348	8.2
260	340	18	33	5	HJ252	6.2
	362	24	43	6	HJ352	11.4
280	360	18	33	5	HJ256	7.39
	390	26	46	6	HJ356	13.9
300	387	20	34.5	5	HJ260	9.14
320	415	21	37	5	HJ264	11.3

1) Minimal allowable dimension for chamfer dimension *r*. Note: 1. This L type collar ring is used with **NU** type cylindrical roller bearings; in duplex arrangements with **NJ** or **NU** type bearing numbers, they become **NH** type and **NUJ** type respectively. For bearing dimensions, allowable rotations, and mass, please refer to pages **B-94** to **B-97**. 2. " * " indicates L type collar rings that can also be used with dimension series **22** bearings.

Double Row Cylindrical Roller Bearings

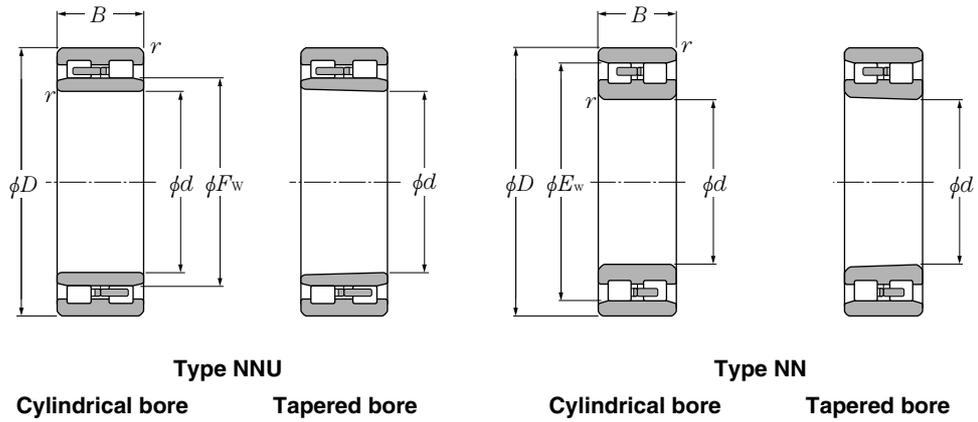

d 25 ~ 110mm

d	Boundary dimensions			Basic load ratings				Limiting speeds		Bearing	
	mm	mm	mm	dynamic kN	static kN	dynamic kgf	static kgf	grease	oil	type NNU cylindrical bore	type NNU tapered ¹⁾ bore
25	47	16	0.6	25.8	30.0	2 630	3 050	14 000	17 000	—	—
30	55	19	1	31.0	37.0	3 150	3 800	12 000	15 000	—	—
35	62	20	1	38.0	47.5	3 850	4 850	11 000	13 000	—	—
40	68	21	1	43.5	55.5	4 400	5 650	9 700	11 000	—	—
45	75	23	1	52.0	68.5	5 300	7 000	8 800	10 000	—	—
50	80	23	1	53.0	72.5	5 400	7 400	8 000	9 400	—	—
55	90	26	1.1	69.5	96.5	7 050	9 850	7 300	8 600	—	—
60	95	26	1.1	71.0	102	7 250	10 400	6 700	7 900	—	—
65	100	26	1.1	75.0	111	7 650	11 400	6 200	7 300	—	—
70	110	30	1.1	94.5	143	9 650	14 600	5 800	6 800	—	—
75	115	30	1.1	96.5	149	9 850	15 200	5 400	6 300	—	—
80	125	34	1.1	116	179	11 800	18 200	5 100	5 900	—	—
85	130	34	1.1	122	194	12 400	19 800	4 800	5 600	—	—
90	140	37	1.5	143	228	14 600	23 200	4 500	5 300	—	—
95	145	37	1.5	146	238	14 900	24 200	4 300	5 000	—	—
100	140	40	1.1	131	260	13 300	26 500	4 300	5 100	NNU4920	NNU4920K
	150	37	1.5	153	256	15 600	26 100	4 000	4 800	—	—
105	145	40	1.1	133	268	13 500	27 400	4 100	4 800	NNU4921	NNU4921K
	160	41	2	198	320	20 200	33 000	3 800	4 500	—	—
110	150	40	1.1	137	284	14 000	28 900	3 900	4 600	NNU4922	NNU4922K
	170	45	2	229	375	23 300	38 000	3 600	4 300	—	—

1) "K" indicates bearings have tapered bore with a taper ratio of 1: 12. 2) Smallest allowable dimension for chamfer dimension r.

● Double Row Cylindrical Roller Bearings

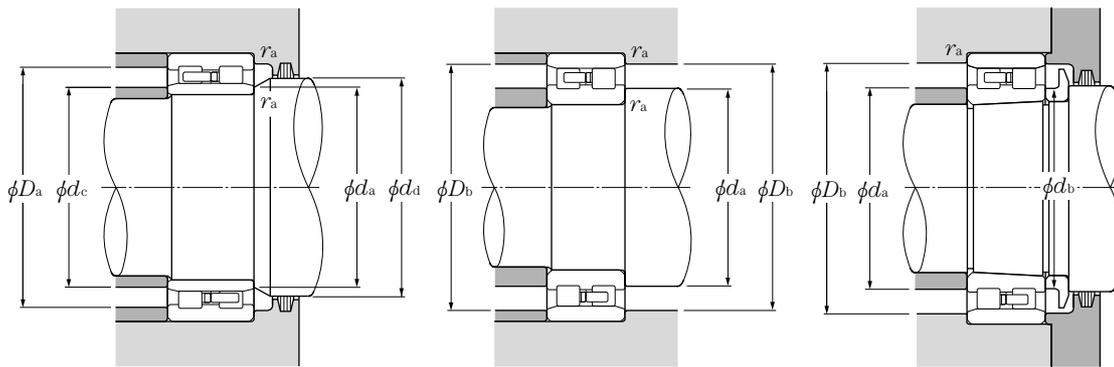

Dynamic equivalent radial load
 $P_r = F_r$
Static equivalent radial load
 $P_{0r} = F_r$

numbers	Dimensions				Abutment and fillet dimensions							Mass (approx.)			
	type NN		mm		mm							type NNU		type NN	
	cylindrical bore	tapered ¹⁾ bore	F_w	E_w	d_a min	d_b min	d_c max	d_d min	D_a max	D_b max	D_b min	r_{as} max	cylindrical bore	tapered bore	cylindrical bore
NN3005	NN3005K	—	41.3	29	30	—	—	—	43	42	0.6	—	—	0.124	0.121
NN3006	NN3006K	—	48.5	35	36.5	—	—	—	50	49	1	—	—	0.199	0.193
NN3007	NN3007K	—	55	40	41.5	—	—	—	57	56	1	—	—	0.242	0.235
NN3008	NN3008K	—	61	45	47	—	—	—	63	62	1	—	—	0.312	0.303
NN3009	NN3009K	—	67.5	50	52	—	—	—	70	69	1	—	—	0.405	0.393
NN3010	NN3010K	—	72.5	55	57	—	—	—	75	74	1	—	—	0.433	0.419
NN3011	NN3011K	—	81	61.5	63.5	—	—	—	83.5	82	1	—	—	0.651	0.631
NN3012	NN3012K	—	86.1	66.5	68.5	—	—	—	88.5	87	1	—	—	0.704	0.683
NN3013	NN3013K	—	91	71.5	73.5	—	—	—	93.5	92	1	—	—	0.758	0.735
NN3014	NN3014K	—	100	76.5	79	—	—	—	103.5	101	1	—	—	1.04	1.01
NN3015	NN3015K	—	105	81.5	84	—	—	—	108.5	106	1	—	—	1.14	1.11
NN3016	NN3016K	—	113	86.5	89.5	—	—	—	118.5	114	1	—	—	1.52	1.47
NN3017	NN3017K	—	118	91.5	94.5	—	—	—	123.5	119	1	—	—	1.61	1.56
NN3018	NN3018K	—	127	98	101	—	—	—	132	129	1.5	—	—	2.07	2.01
NN3019	NN3019K	—	132	103	106	—	—	—	137	134	1.5	—	—	2.17	2.1
NN4920	NN4920K	113	129	106.5	110	111	115	133.5	133.5	131	1	1.83	1.75	1.75	1.67
NN3020	NN3020K	—	137	108	111	—	—	—	142	139	1.5	—	—	2.26	2.19
NN4921	NN4921K	118	134	111.5	115	116	120	138.5	138.5	136	1	1.91	1.82	1.82	1.73
NN3021	NN3021K	—	146	114	117	—	—	—	151	148	2	—	—	2.89	2.8
NN4922	NN4922K	123	139	116.5	120	121	125	143.5	143.5	141	1	1.99	1.9	1.9	1.81
NN3022	NN3022K	—	155	119	123	—	—	—	161	157	2	—	—	3.69	3.56

Double Row Cylindrical Roller Bearings

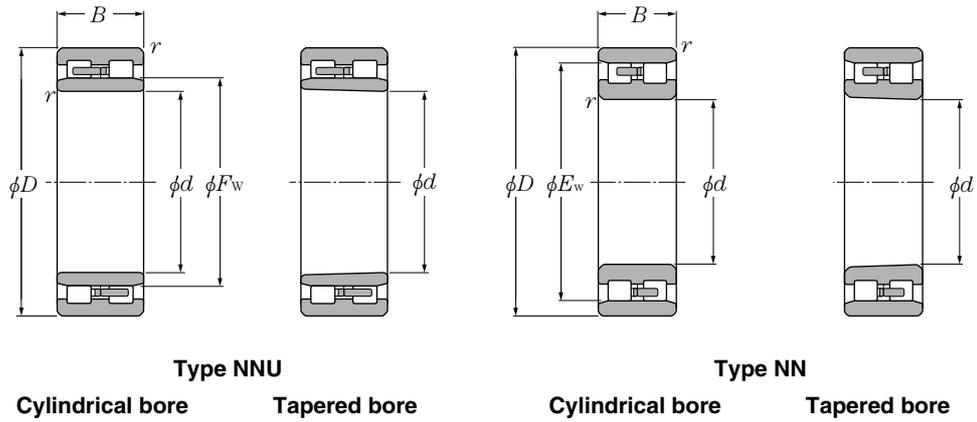

d 120 ~ 280mm

d	Boundary dimensions			Basic load ratings				Limiting speeds		Bearing	
	D	B	$r_s \text{ min}^{(2)}$	dynamic kN	static kN	dynamic kgf	static kgf	grease	oil	type NNU cylindrical bore	tapered ¹⁾ bore
120	165	45	1.1	183	360	18 700	37 000	3 600	4 200	NNU4924	NNU4924K
	180	46	2	233	390	23 700	40 000	3 300	3 900	—	—
130	180	50	1.5	220	440	22 400	45 000	3 300	3 900	NNU4926	NNU4926K
	200	52	2	284	475	29 000	48 500	3 100	3 600	—	—
140	190	50	1.5	227	470	23 100	48 000	3 000	3 600	NNU4928	NNU4928K
	210	53	2	298	515	30 500	52 500	2 800	3 300	—	—
150	210	60	2	345	690	35 000	70 500	2 800	3 300	NNU4930	NNU4930K
	225	56	2.1	335	585	34 000	60 000	2 600	3 100	—	—
160	220	60	2	355	740	36 500	75 500	2 600	3 100	NNU4932	NNU4932K
	240	60	2.1	375	660	38 000	67 500	2 500	2 900	—	—
170	230	60	2	360	765	37 000	78 000	2 500	2 900	NNU4934	NNU4934K
	260	67	2.1	440	775	45 000	79 000	2 300	2 700	—	—
180	250	69	2	460	965	46 500	98 500	2 300	2 700	NNU4936	NNU4936K
	280	74	2.1	565	995	57 500	102 000	2 200	2 600	—	—
190	260	69	2	475	1 030	48 500	105 000	2 200	2 600	NNU4938	NNU4938K
	290	75	2.1	580	1 040	59 000	106 000	2 000	2 400	—	—
200	280	80	2.1	555	1 180	56 500	120 000	2 100	2 400	NNU4940	NNU4940K
	310	82	2.1	655	1 170	66 500	119 000	1 900	2 300	—	—
220	300	80	2.1	585	1 300	59 500	132 000	1 900	2 200	NNU4944	NNU4944K
	340	90	3	815	1 480	83 000	151 000	1 700	2 100	—	—
240	320	80	2.1	610	1 410	62 500	144 000	1 700	2 000	NNU4948	NNU4948K
	360	92	3	855	1 600	87 000	163 000	1 600	1 900	—	—
260	360	100	2.1	900	2 070	92 000	211 000	1 600	1 800	NNU4952	NNU4952K
	400	104	4	1 060	1 990	108 000	203 000	1 500	1 700	—	—
280	380	100	2.1	925	2 200	94 500	224 000	1 400	1 700	NNU4956	NNU4956K
	420	106	4	1 080	2 080	110 000	212 000	1 300	1 600	—	—

1) "K" indicates bearings have tapered bore with a taper ratio of 1: 12. 2) Smallest allowable dimension for chamfer dimension r.

Double Row Cylindrical Roller Bearings

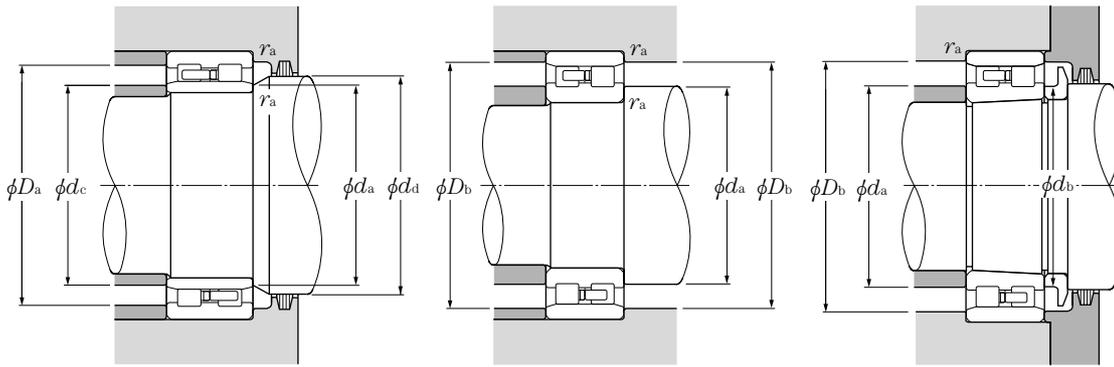

Dynamic equivalent radial load
 $P_r = F_r$
Static equivalent radial load
 $P_{0r} = F_r$

numbers		Dimensions				Abutment and fillet dimensions							Mass (approx.) kg			
type NN cylindrical bore	tapered ¹⁾ bore	mm		d_a min	d_b min	d_c max	d_d min	D_a max	D_b max	r_a max	type NNU	type NN		type NN	type NN	
		F_w	E_w									cylindrical bore	tapered bore			cylindrical bore
NN4924	NN4924K	134.5	154.5	126.5	130	133	137	158.5	158.5	156.5	1	2.75	2.63	2.63	2.51	
NN3024	NN3024K	—	165	129	133	—	—	—	171	167	2	—	—	3.98	3.83	
NN4926	NN4926K	146	168	138	142	144	148	172	172	170	1.5	3.69	3.52	3.52	3.35	
NN3026	NN3026K	—	182	139	143	—	—	—	191	183	2	—	—	5.92	5.71	
NN4928	NN4928K	156	178	148	152	154	158	182	182	180	1.5	3.94	3.76	3.76	3.58	
NN3028	NN3028K	—	192	149	153	—	—	—	201	194	2	—	—	6.44	6.21	
NN4930	NN4930K	168.5	196.5	159	164	166	171	201	201	198.5	2	6.18	5.9	5.9	5.62	
NN3030	NN3030K	—	206	161	166	—	—	—	214	208	2	—	—	7.81	7.53	
NN4932	NN4932K	178.5	206.5	169	174	176	182	211	211	208.5	2	6.53	6.23	6.24	5.94	
NN3032	NN3032K	—	219	171	176	—	—	—	229	221	2	—	—	8.92	8.59	
NN4934	NN4934K	188.5	216.5	179	184	186	192	221	221	218.5	2	6.87	6.55	6.56	6.24	
NN3034	NN3034K	—	236	181	187	—	—	—	249	238	2	—	—	12.6	12.2	
NN4936	NN4936K	202	234	189	195	199	205	241	241	236	2	9.9	9.46	9.45	9.01	
NN3036	NN3036K	—	255	191	197	—	—	—	269	257	2	—	—	16.6	16	
NN4938	NN4938K	212	244	199	205	209	215	251	251	246	2	10.4	9.94	9.93	9.47	
NN3038	NN3038K	—	265	201	207	—	—	—	279	267	2	—	—	18	17.4	
NN4940	NN4940K	225	261	211	218	222	228	269	269	264	2	14.7	14	14	13.3	
NN3040	NN3040K	—	282	211	218	—	—	—	299	285	2	—	—	21.6	20.8	
NN4944	NN4944K	245	281	231	238	242	248	289	289	284	2	15.9	15.2	15.2	14.5	
NN3044	NN3044K	—	310	233	240	—	—	—	327	313	2.5	—	—	29.3	28.2	
NN4948	NN4948K	265	301	251	258	262	269	309	309	304	2	17.2	16.4	16.4	15.6	
NN3048	NN3048K	—	330	253	261	—	—	—	347	333	2.5	—	—	32.8	31.6	
NN4952	NN4952K	292	336	271	279	288	296	349	349	339	2	29.6	28.3	28.3	27	
NN3052	NN3052K	—	364	276	285	—	—	—	384	367	3	—	—	47.4	45.8	
NN4956	NN4956K	312	356	291	299	308	316	369	369	359	2	31.6	30.2	30.2	28.8	
NN3056	NN3056K	—	384	296	305	—	—	—	404	387	3	—	—	51.1	49.3	

Double Row Cylindrical Roller Bearings

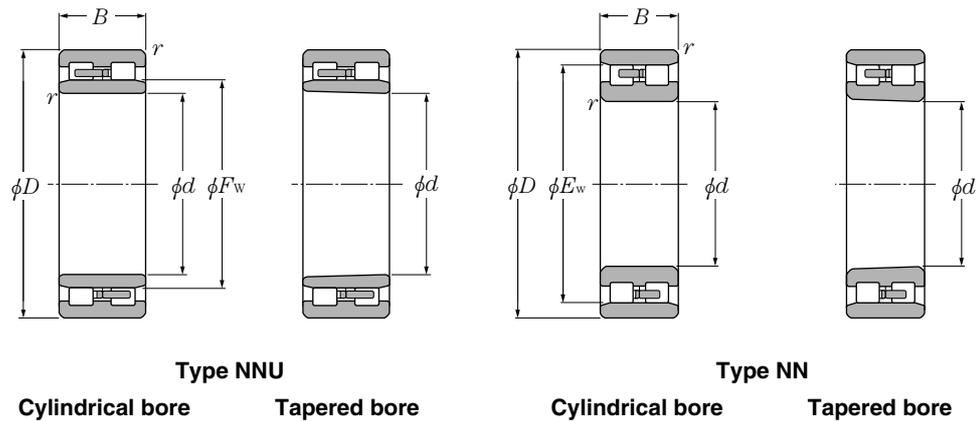

d 300 ~ 500mm

d	Boundary dimensions			Basic load ratings				Limiting speeds		Bearing	
	D	B	$r_{s \min}^{2)}$	dynamic kN	static kN	dynamic kgf	static kgf	grease	oil	type NNU cylindrical bore	tapered ¹⁾ bore
300	420	118	3	1 200	2 800	122 000	285 000	1 300	1 500	NNU4960	NNU4960K
	460	118	4	1 330	2 560	135 000	261 000	1 200	1 500	—	—
320	440	118	3	1 240	2 970	126 000	305 000	1 200	1 400	NNU4964	NNU4964K
	480	121	4	1 350	2 670	138 000	272 000	1 100	1 300	—	—
340	460	118	3	1 270	3 150	130 000	320 000	1 100	1 300	NNU4968	NNU4968K
	520	133	5	1 620	3 200	165 000	325 000	1 100	1 300	—	—
360	480	118	3	1 270	3 250	130 000	330 000	1 100	1 300	NNU4972	NNU4972K
	540	134	5	1 650	3 300	169 000	340 000	1 000	1 200	—	—
380	520	140	4	1 630	4 050	167 000	415 000	1 000	1 200	NNU4976	NNU4976K
	560	135	5	1 690	3 450	172 000	355 000	940	1 100	—	—
400	540	140	4	1 690	4 300	172 000	435 000	940	1 100	NNU4980	NNU4980K
	600	148	5	2 040	4 150	208 000	420 000	880	1 000	—	—
420	560	140	4	1 740	4 500	177 000	460 000	900	1 100	NNU4984	NNU4984K
	620	150	5	2 080	4 300	212 000	440 000	840	990	—	—
440	600	160	4	2 150	5 550	219 000	565 000	850	1 000	NNU4988	NNU4988K
	650	157	6	2 420	5 100	247 000	520 000	800	940	—	—
460	620	160	4	2 220	5 850	226 000	595 000	800	950	NNU4992	NNU4992K
	680	163	6	2 550	5 350	260 000	545 000	750	890	—	—
480	650	170	5	2 280	5 900	233 000	600 000	770	910	NNU4996	NNU4996K
500	670	170	5	2 360	6 200	240 000	635 000	730	860	NNU49/500	NNU49/500K

1) "K" indicates bearings have tapered bore with a taper ratio of 1: 12. 2) Smallest allowable dimension for chamfer dimension r.

● Double Row Cylindrical Roller Bearings

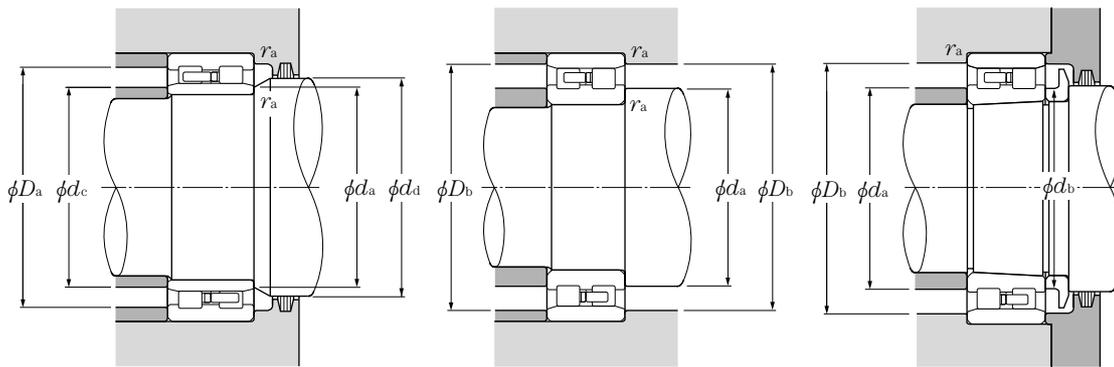

Dynamic equivalent radial load
 $P_r = F_r$
Static equivalent radial load
 $P_{0r} = F_r$

numbers		Dimensions		Abutment and fillet dimensions							Mass (approx.)				
type NN cylindrical bore	tapered ¹⁾ bore	mm		d_a min	d_b min	d_c max	d_d min	D_a max	D_b max	D_b min	r_{as} max	type NNU		type NN	
		F_w	E_w									cylindrical bore	tapered bore	cylindrical bore	tapered bore
NN4960	NN4960K	339	391	313	323	335	343	407	407	394	2.5	48.6	46.4	46.4	44.2
NN3060	NN3060K	—	418	316	326	—	—	—	444	421	3	—	—	70.8	68.6
NN4964	NN4964K	359	411	333	343	355	363	427	427	414	2.5	51.4	49.1	49	46.7
NN3064	NN3064K	—	438	336	346	—	—	—	464	441	3	—	—	76.2	73.5
—	—	379	—	353	363	375	383	447	—	—	2.5	54.2	51.7	—	—
NN3068	NN3068K	—	473	360	371	—	—	—	500	477	4	—	—	102	98.5
—	—	398	—	373	383	394	402	467	—	—	2.5	57	54.4	—	—
NN3072	NN3072K	—	493	380	391	—	—	—	520	497	4	—	—	107	103
—	—	425	—	396	408	420	430	504	—	—	3	84.5	80.6	—	—
NN3076	NN3076K	—	512	400	411	—	—	—	540	516	4	—	—	113	109
—	—	445	—	416	428	440	450	524	—	—	3	88.2	84.1	—	—
NN3080	NN3080K	—	547	420	432	—	—	—	580	551	4	—	—	146	141
—	—	465	—	436	448	460	470	544	—	—	3	92	87.7	—	—
NN3084	NN3084K	—	567	440	452	—	—	—	600	571	4	—	—	154	148
—	—	492	—	456	469	487	497	584	—	—	3	127	121	—	—
NN3088	NN3088K	—	596	464	477	—	—	—	626	601	5	—	—	178	172
—	—	512	—	476	489	507	517	604	—	—	3	132	126	—	—
NN3092	NN3092K	—	622	484	498	—	—	—	656	627	5	—	—	202	195
—	—	534	—	500	514	531	541	630	—	—	4	156	149	—	—
—	—	556	—	520	534	551	561	650	—	—	4	162	155	—	—

Four-Row Cylindrical Roller Bearings

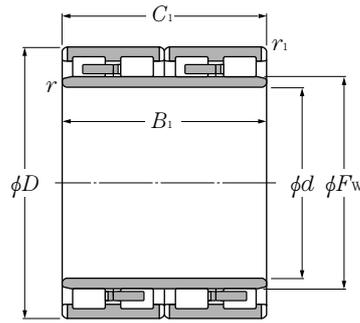

Drawing 1

d 120 ~ 200mm

d	Boundary dimensions					Basic load ratings				
	D	B ₁	C ₁	r _{s min} ¹⁾	r _{1s min} ¹⁾	d _r kN	C _{or} static	C _r dynamic	C _{or} static	
mm										
kgf										
120	180	92	92	2.5	2.5	400	785	40 500	80 000	
	180	105	105	2.5	2.5	445	855	45 500	87 000	
130	200	104	104	2.5	2.5	490	955	49 500	97 000	
140	210	116	116	2.5	2.5	510	1 030	52 000	105 000	
145	210	155	155	2.5	2.5	705	1 640	71 500	168 000	
	225	156	156	2.5	2.5	810	1 750	82 500	178 000	
150	220	150	150	2.5	2.5	750	1 640	76 500	168 000	
	230	130	130	2.5	2.5	725	1 520	73 500	155 000	
	230	156	156	2.5	2.5	930	2 040	95 000	208 000	
	250	150	150	2.5	2.5	885	1 640	90 500	167 000	
160	220	180	180	2.5	2.5	920	2 490	93 500	254 000	
	230	130	130	2.5	2.5	665	1 340	68 000	136 000	
	230	168	168	2.5	2.5	915	2 170	93 500	222 000	
	240	170	170	2	2.5	980	2 290	100 000	234 000	
170	230	120	120	2.5	2.5	620	1 520	63 000	155 000	
	240	156	156	2.5	2.5	905	2 170	92 500	222 000	
	240	160	160	2.5	2.5	905	2 180	92 000	222 000	
	250	168	168	2.5	2.5	970	2 220	99 000	226 000	
	255	180	180	2.5	2.5	1 100	2 430	112 000	247 000	
	260	150	150	2.5	2.5	835	1 750	85 000	179 000	
	260	225	225	2.5	2.5	1 310	3 150	134 000	320 000	
180	250	156	156	2.5	2.5	895	2 180	91 500	223 000	
	260	168	168	2.5	2.5	1 020	2 400	104 000	244 000	
	265	180	180	2.5	2.5	1 090	2 510	111 000	256 000	
190	260	168	168	2.5	2.5	980	2 600	100 000	265 000	
	270	170	170	2.5	2.5	1 090	2 660	111 000	272 000	
	270	200	200	2.5	2.5	1 260	3 100	128 000	315 000	
	280	200	200	2.5	2.5	1 240	2 910	126 000	297 000	
200	270	170	170	2.5	2.5	970	2 610	99 000	266 000	
	280	190	190	2.5	2.5	1 190	3 150	121 000	320 000	
	280	200	200	2.5	2.5	1 310	3 300	134 000	335 000	

1) Minimal allowable dimension for chamfer dimension r or r_1 . 2) An oil hole and groove are provided in the center of the outer ring. The oil groove is not provided on the side.

● Four-Row Cylindrical Roller Bearings

Bearing numbers	Dimensions F_w	Drawing no.	Mass
			kg (approx.)
4R2437	137	1	8.2
4R2438	135	1	9.3
4R2628	150	1	12.1
4R2823	160	1	13.9
4R2906	166	1	18
4R2908	169	1	23.4
4R3031	168	1	19.4
4R3029	174	1	20
4R3040	174	1	24.5
4R3039	177	1	29.6
4R3224	177	1	20.2
4R3226	180	1	16.6
4R3232	179	1	23.4
4R3225	183	1	27.8
4R3426	187	1	14.2
4R3429	189	1	22.2
4R3423	190	1	22.8
4R3432	193	1	28.2
4R3425	193	1	19.3
4R3433	192	1	29.5
4R3431	196	1	44
4R3625	200	1	23.2
4R3628	202	1	29.4
4R3618	204	1	34.2
4R3820	212	1	26.9
4R3818	213	1	31.7
4R3821	212	1	37.5
4R3823	214	1 ²⁾	41.5
4R4039	222	1	28.5
4R4026	223	1	36.7
4R4037	222	1	40.5

Note: **Drawing 1** represents a bearing with solid rollers and machined cage.

Four-Row Cylindrical Roller Bearings

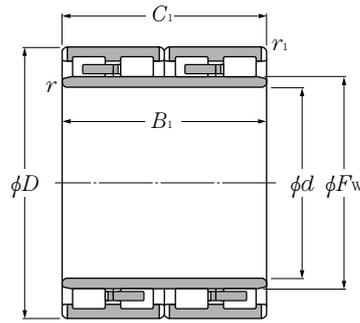

Drawing 1

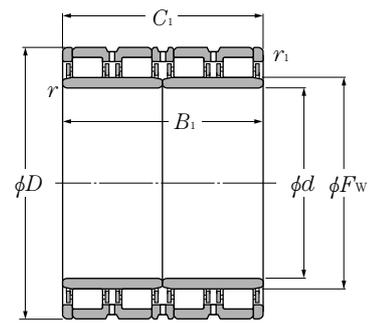

Drawing 2

d 200 ~ 300mm

d	Boundary dimensions					Basic load ratings			
	D	B ₁	C ₁	r _s min ¹⁾	r _{1s} min ¹⁾	dynamic C _r kN	static C _{or}	dynamic C _r kgf	static C _{or}
200	290	192	192	2.5	2.5	1 290	3 150	132 000	320 000
	320	216	216	3	3	1 750	3 650	179 000	375 000
210	290	192	192	2.5	2.5	1 230	3 350	126 000	340 000
220	290	192	192	2.5	2.5	1 190	3 350	122 000	340 000
	300	160	160	2.5	2.5	1 000	2 590	102 000	264 000
	310	192	192	2.5	2.5	1 390	3 400	141 000	350 000
	310	204	204	2.5	2.5	1 420	3 750	144 000	385 000
	310	215	215	2.5	2.5	1 530	3 750	156 000	380 000
	310	225	225	2.5	2.5	1 480	3 950	151 000	405 000
	310	265	265	2.5	2.5	1 630	4 500	167 000	460 000
	320	160	160	3	3	1 190	2 550	121 000	260 000
320	210	210	2.5	2.5	1 550	3 650	158 000	370 000	
230	330	206	206	2.5	2.5	1 520	3 800	155 000	385 000
	340	260	260	3	3	2 050	5 100	209 000	520 000
240	330	220	220	3	3	1 490	4 150	152 000	420 000
	340	220	220	3	3	1 670	4 200	170 000	425 000
	360	220	220	2.5	2.5	1 760	4 050	179 000	415 000
250	350	220	220	3	3	1 730	4 300	176 000	440 000
260	370	220	220	3	3	1 760	4 450	179 000	455 000
	380	280	280	3	3	2 420	6 250	247 000	635 000
270	380	280	280	2.5	2.5	2 580	6 850	263 000	700 000
280	390	220	220	3	3	1 780	4 650	181 000	475 000
	390	275	275	2.5	2.5	2 290	6 250	233 000	635 000
	420	280	280	4	4	2 430	6 150	248 000	630 000
290	410	240	240	3	3	2 240	5 550	228 000	565 000
	420	300	300	3	3	2 830	7 500	288 000	765 000
300	400	300	300	3	3	2 480	7 500	253 000	765 000
	420	240	240	3	3	2 020	5 450	206 000	555 000
	420	300	300	3	3	2 720	7 600	278 000	775 000
	420	300	300	3	3	2 900	7 850	295 000	800 000

1) Minimal allowable dimension for chamfer dimension r or r_1 . 2) An oil hole and groove are provided in the center of the outer ring.
3) An oil hole and groove are not provided on the outer ring spacer.

● Four-Row Cylindrical Roller Bearings

Bearing numbers	Dimensions F_w	Drawing no.	Mass
			kg (approx.)
4R4041	226	1	42.5
4R4028	231	1	67
4R4206	236	1	39.5
4R4413	239	1	33.8
4R4419	245	1	32.8
4R4426	246	1	46.9
4R4425	247	1	49.8
4R4420	242	1	51.5
4R4416	245	1	54.9
4R4430	245	1	63.5
4R4428	245	1	46.5
4R4429	248	1	60.5
4R4614	258	1	58.6
4R4611	261	1	82.6
4R4811	270	1 ²⁾	56.8
4R4806	268	1	63.6
4R4807	274	1	79.6
4R5008	278	1	66
4R5217	292	1	76.5
4R5213	294	1	109
4R5405	299.7	2 ³⁾	105
4R5611	312	1	81.3
4R5612	312	1	105
4R5605	323	1	139
4R5806	320	1	103
4R5805	327	1	141
E-4R6014	328	1	104
E-4R6017	334	1	106
E-4R6015	334	1	125
E-4R6020	332	2	130

چرخ صنعت کشور

Note: **Drawing 1** represents a bearing with solid rollers and machined cage; **Drawing 2** represents a bearing with hollow rollers and pin type cage.

Four-Row Cylindrical Roller Bearings

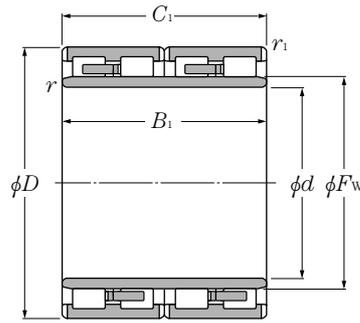

Drawing 1

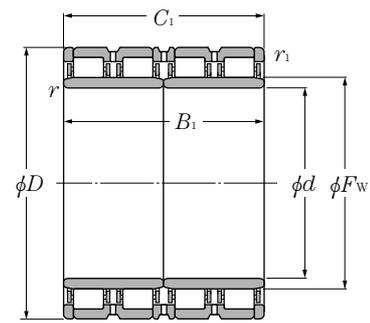

Drawing 2

d 300 ~ 460mm

d	Boundary dimensions					Basic load ratings			
	D	B ₁	C ₁	r _s min ¹⁾	r _{1s} min ¹⁾	dynamic C _r kN	static C _{0r}	dynamic C _r kgf	static C _{0r}
300	420	320	300	3	3	2 900	7 850	295 000	800 000
	460	270	270	3	3	2 510	5 350	256 000	545 000
310	430	240	240	3	3	2 240	5 950	228 000	605 000
320	440	240	230	3	3	2 290	6 050	234 000	615 000
	450	240	240	3	3	2 370	6 150	242 000	630 000
	460	340	340	3	3	3 400	9 450	345 000	960 000
	470	350	350	3	3	4 150	10 900	425 000	1 110 000
330	440	200	200	3	3	1 820	4 850	186 000	495 000
	460	340	340	4	4	3 250	8 850	330 000	905 000
340	480	370	350	5	5	3 450	9 650	350 000	985 000
	490	300	300	4	4	3 350	8 300	340 000	845 000
360	510	400	400	5	5	4 250	11 500	435 000	1 170 000
370	480	230	230	5	5	2 100	6 250	214 000	635 000
	520	400	400	5	5	4 650	13 500	475 000	1 370 000
380	520	280	280	4	4	3 400	9 150	350 000	935 000
	520	300	300	4	4	3 550	9 600	360 000	980 000
	540	400	400	4	4	5 200	15 200	530 000	1 550 000
400	560	400	400	5	5	4 250	11 800	430 000	1 210 000
	560	410	410	4	4	5 750	17 000	585 000	1 730 000
410	546	400	400	5	5	4 200	12 700	430 000	1 290 000
420	560	280	280	4	4	3 150	8 750	320 000	895 000
	580	230	230	4	4	2 430	6 250	248 000	635 000
	620	400	400	5	5	5 000	13 400	510 000	1 360 000
440	620	450	450	5	5	6 450	18 700	660 000	1 910 000
460	620	400	400	4	4	5 350	16 700	545 000	1 700 000
	620	400	400	4	4	4 950	15 000	505 000	1 530 000
	650	470	470	5	5	7 150	20 600	730 000	2 100 000

1) Minimal allowable dimension for chamfer dimension r or r₁. 2) Oil inlet and oil groove are in center of the outer ring; no oil groove on the side. 3) Oil inlet in space of outer ring; no oil groove. 4) One-piece inner ring.

● Four-Row Cylindrical Roller Bearings

Bearing numbers	Dimensions F_w	Drawing no.	Mass
			kg (approx.)
E-4R6018	332	2	136
E-4R6019	344	1	162
E-4R6202	344.5	1	108
E-4R6414	351	1	106
E-4R6411	358	1	125
E-4R6412	360	1	178
E-4R6406	361.7	2	212
E-4R6603	360	1 ²⁾	83.6
E-4R6605	365	1	181
E-4R6811	378	1	198
E-4R6804	377	1	187
E-4R7203	397	1 ²⁾	262
E-4R7405	400	1	106
E-4R7404	409	1	273
E-4R7605	417	1	174
E-4R7607	416	2 ³⁾	210
E-4R7604	422	2 ³⁾	325
E-4R8007	446	1	303
E-4R8010	445	2	349
E-4R8201	444	1 ²⁾	256
E-4R8403	457	1	189
E-4R8404	466	1	181
E-4R8401	478	1	410
E-4R8801	487	2	437
E-4R9211	502	2 ³⁾⁴⁾	383
E-4R9209	502	1	341
E-4R9216	509	2	540

چرخ صنعت کشور

Note: **Drawing 1** represents a bearing with solid rollers and machined cage; **Drawing 2** represents a bearing with hollow rollers and pin type cage.

Four-Row Cylindrical Roller Bearings

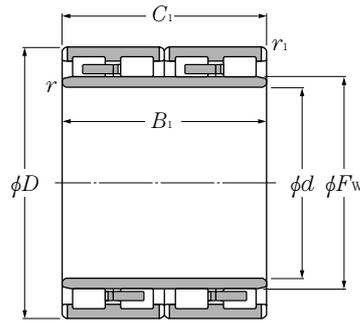

Drawing 1

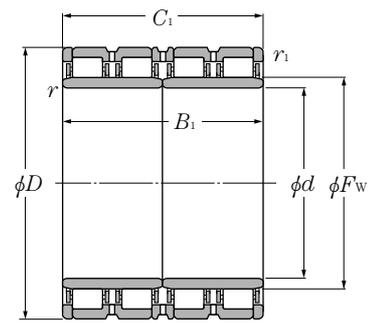

Drawing 2

d 480 ~ 690mm

d	Boundary dimensions					Basic load ratings			
	D	B ₁	C ₁	r _{s min} ¹⁾	r _{1s min} ¹⁾	dynamic kN C _r	static C _{0r}	dynamic kgf C _r	static C _{0r}
480	650	420	420	5	5	5 950	18 100	605 000	1 840 000
	650	450	450	9.5X20°	5	7 100	21 600	720 000	2 200 000
	680	500	500	6	6	7 950	24 000	810 000	2 450 000
500	680	420	405	5	5	7 100	22 900	725 000	2 340 000
	690	470	470	5	5	7 650	22 500	780 000	2 290 000
	690	510	510	5	5	7 750	24 600	790 000	2 500 000
	700	515	515	5	5	7 900	24 100	805 000	2 450 000
	710	480	480	6	6	8 650	24 700	880 000	2 520 000
510	670	320	320	5	5	4 550	13 500	465 000	1 380 000
	700	540	540	6	6	8 300	25 000	845 000	2 550 000
520	700	540	540	6	6	8 200	25 500	835 000	2 600 000
	735	535	535	5	5	9 000	26 600	915 000	2 710 000
530	700	540	540	6	6	7 850	25 400	800 000	2 590 000
	760	520	520	6	6	9 150	26 700	935 000	2 730 000
	780	570	570	6	6	10 300	29 100	1 050 000	2 970 000
550	800	520	520	6	6	9 450	27 000	965 000	2 750 000
560	680	360	360	3	3	4 650	16 500	475 000	1 680 000
570	815	594	594	6	6	11 800	34 500	1 200 000	3 500 000
600	820	575	575	12X20°	6	10 000	31 500	1 020 000	3 200 000
	870	540	540	7.5	7.5	10 600	29 600	1 090 000	3 000 000
	870	640	640	7.5	7.5	13 600	40 500	1 390 000	4 150 000
610	870	660	660	9.5	7.5	12 600	40 000	1 280 000	4 100 000
650	920	670	670	7.5	4	14 600	46 000	1 490 000	4 700 000
	920	690	690	7.5	7.5	14 300	46 500	1 460 000	4 750 000
660	820	440	440	5	4	7 300	27 800	745 000	2 840 000
690	980	715	715	7.5	7.5	16 800	54 500	1 720 000	5 550 000

1) Minimal allowable dimension for chamfer dimension r or r_1 . 2) Oil inlet and oil groove are in center of the outer ring; no oil groove on the side. 3) Oil inlet in space of outer ring; no oil groove.

● Four-Row Cylindrical Roller Bearings

Bearing numbers	Dimensions	Drawing no.	Mass
			kg (approx.)
	F_w		
E-4R9607	523	2 ¹⁾	369
E-4R9609	525	2 ¹⁾	395
E-4R9604	532	2	640
E-4R10010	550	2 ³⁾	495
E-4R10016	547	2	590
E-4R10006	552	2	640
E-4R10011	554	2	680
E-4R10008	556	2	675
E-4R10015	568	2	780
E-4R10201	554	2 ¹⁾	335
E-4R10202	558	2	689
E-4R10403	564	2	658
E-4R10402	574.5	2	740
E-4R10603	574	2	626
E-4R10601	590	2	800
E-4R10602	601	2	1 010
E-4R11001	622	2	965
E-4R11202	590	1	265
E-4R11402	628	2	1 040
E-4R12003	655	2	980
E-4R12002	672	2	1 150
E-4R12001	672	2	1 330
E-4R12202	680	2 ²⁾	1 400
E-4R13005	723	2	1 500
E-4R13003	723	2	1 550
E-4R13201	702	2	580
E-4R13802	767.5	2	1 850

4) One-piece inner ring. Note: **Drawing 1** represents a bearing with solid rollers and machined cage; **Drawing 2** represents a bearing with hollow rollers and pin type cage.

Four-Row Cylindrical Roller Bearings

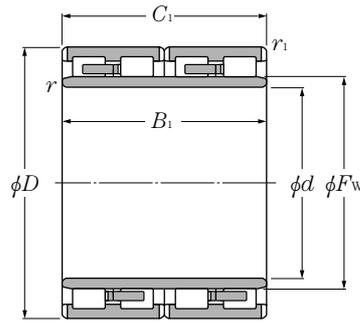

Drawing 1

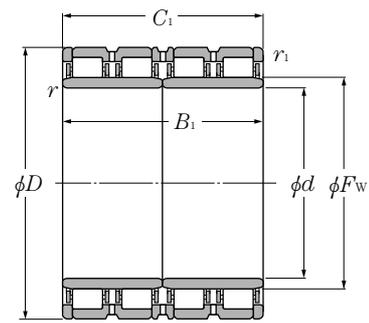

Drawing 2

d 700 ~ 1 200mm

d	Boundary dimensions					Basic load ratings				
	D	B ₁	C ₁	r _{s min} ¹⁾	r _{1s min} ¹⁾	dynamic C _r kN	static C _{0r}	dynamic C _r kgf	static C _{0r}	
700	930	620	620	15X20°	6	12 900	43 000	1 320 000	4 400 000	
710	1 000	715	715	9.5	6	16 800	54 500	1 710 000	5 550 000	
725	1 000	700	700	6	6	15 900	53 500	1 620 000	5 450 000	
750	1 050	745	720	7.5	7.5	17 600	58 000	1 790 000	5 900 000	
	1 090	745	720	7.5	7.5	19 100	60 500	1 950 000	6 150 000	
760	1 030	750	750	7.5	7.5	17 300	59 500	1 760 000	6 050 000	
	1 080	805	790	6	6	18 700	61 000	1 900 000	6 250 000	
	1 100	745	720	7.5	7.5	19 100	60 500	1 950 000	6 150 000	
800	1 080	700	700	7.5	7.5	16 500	55 000	1 680 000	5 600 000	
	1 080	750	750	6	6	17 300	59 000	1 760 000	6 000 000	
820	1 130	800	800	7.5	7.5	19 600	66 500	2 000 000	6 800 000	
	1 130	825	800	7.5	7.5	19 600	66 500	2 000 000	6 800 000	
	1 160	840	840	7.5	7.5	21 600	71 000	2 200 000	7 250 000	
840	1 160	840	840	5	7.5	21 600	71 000	2 200 000	7 250 000	
850	1 150	650	650	9.5	9.5	15 700	51 000	1 610 000	5 200 000	
	1 150	800	800	6	6	19 700	71 000	2 010 000	7 250 000	
	1 180	650	650	7.5	7.5	16 400	51 500	1 670 000	5 250 000	
	1 180	850	850	9.5	9.5	24 100	78 500	2 460 000	8 000 000	
860	1 160	735	710	6	6	17 800	62 500	1 810 000	6 400 000	
900	1 230	895	870	7.5	7.5	24 700	88 000	2 520 000	9 000 000	
920	1 280	865	850	7.5	7.5	26 200	88 500	2 670 000	9 000 000	
1000	1 310	880	880	9.5	9.5	23 400	88 500	2 380 000	9 000 000	
	1 360	800	800	7.5	7.5	25 000	85 000	2 550 000	8 650 000	
1030	1 380	850	850	7.5	7.5	24 400	89 000	2 490 000	9 100 000	
1200	1 590	1 050	1 050	7.5	7.5	36 000	133 000	3 650 000	13 600 000	

1) Minimal allowable dimension for chamfer dimension r or r_1 . 2) Inner ring is divided into four. 3) The oil hole of the outer ring is provided with fitting nozzle for oil mist.

● Four-Row Cylindrical Roller Bearings

Bearing numbers	Dimensions F_w	Drawing no.	Mass
			kg (approx.)
E-4R14003	763	2	1 200
E-4R14205	787.5	2 ³⁾	1 900
E-4R14501	796	2	1 730
E-4R15001	830	2 ³⁾	2 180
E-4R15002	845	2 ³⁾	2 530
E-4R15204	828	2 ³⁾	2 000
E-4R15207	845	2 ³⁾	2 550
E-4R15203	855	2 ³⁾	2 560
E-4R16004	870	2	1 950
E-4R16005	880	2	2 090
E-4R16406	903	2 ³⁾	2 450
E-4R16405	903	2	2 520
E-4R16403	910	2	2 930
E-4R16801	920	2	2 840
E-4R17001	941	2	1 980
E-4R17003	930	2	2 430
E-4R17004	945	2	2 270
E-4R17002	928	2	2 970
E-4R17201	940	2	2 310
E-4R18001	985	2 ³⁾	3 250
E-4R18401	1 015	2	3 560
E-4R20001	1 080	2	3 260
E-4R20002	1 090	2	3 530
E-4R20601	1 124	2	3 800
E-4R24002	1 295	2 ³⁾	6 220

چرخ صنعت کشور

Note: **Drawing 2** represents a bearing with hollow rollers and pin type cage.



طینعت کشور





Single row tapered roller bearings

Double row tapered roller bearings

Four row tapered roller bearings

1. Types, design features, and characteristics

Tapered roller bearings are designed so the tapered vertex of the raceway surfaces of the inner and outer rings and rollers converge at one point on the centerline of the bearing.

Due to this design feature, rollers move along the center of the raceway surfaces. The tapered rollers are guided by the compound force of the inner and outer raceway surfaces which keep them pressed up against the large rib on the inner ring. A large variety of these bearings, including single, double, and four row arrangements, are in use both in metric and inch series.

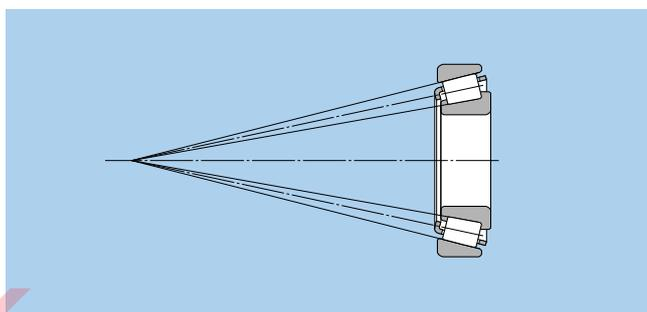
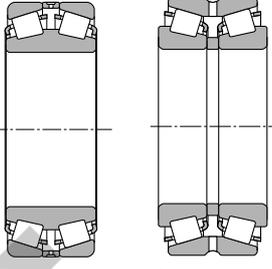
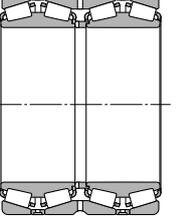

Diagram 1.

Table 1 Tapered roller bearing types and characteristics

Type	Characteristics									
<p>Single row tapered roller bearings</p>	<p>(1) There are both metric and inch series, and they have been standardized as shown in the following table.</p> <p>Dimension series</p> <table border="1" data-bbox="395 1283 1115 1451"> <thead> <tr> <th></th> <th>Metric series</th> <th>Inch series</th> </tr> </thead> <tbody> <tr> <td>Regulations</td> <td> <ul style="list-style-type: none"> • JIS B 1512 • ISO 355 </td> <td> <ul style="list-style-type: none"> • ABMA (includes metric J-series) </td> </tr> <tr> <td>Basic number</td> <td> Example, 30210 * T2EE040 </td> <td> Inner ring no. / outer ring no. ("J" appears at the beginning of the basic number in the case of J-series.) </td> </tr> </tbody> </table> <p>* Dimension series previously not covered by 3XX are regulated under JIS B 1512; dimensions previously missing from 3XX will henceforth use the bearing number.</p> <p>(2) In addition to level type, there are also medium contact angle and large contact angle types, and the contact angle code C and D, respectively, is appended to the basic numbers of the latter two types.</p> <p>(3) Subunits Tapered roller bearings can be disassembled into parts — the inner ring, rollers, and cage (collectively known as the "cone") — and the outer ring (known as the "cup"). These are the bearing's "subunits". Subunit dimensions are standardized under ISO or ABMA standards, and unified subunits are interchangeable within each dimensional standard. However, high precision grade bearings are generally not interchangeable, and these subunits must be used by assembling only subunits with identical manufacturing numbers. Aside from any cautionary notes that may appear, the single row tapered roller bearings listed in the dimension tables have subunits standardized for both metric and inch systems (including J series). (Refer to Diagram 2)</p> <div data-bbox="387 1809 900 2056"> <p>Subunit dimensions</p> <p>E : Outer ring (cup) nominal small-end diameter α : Nominal contact angle</p> </div> <p style="text-align: right;">Continued on next page ➔</p>		Metric series	Inch series	Regulations	<ul style="list-style-type: none"> • JIS B 1512 • ISO 355 	<ul style="list-style-type: none"> • ABMA (includes metric J-series) 	Basic number	Example, 30210 * T2EE040	Inner ring no. / outer ring no. ("J" appears at the beginning of the basic number in the case of J-series.)
	Metric series	Inch series								
Regulations	<ul style="list-style-type: none"> • JIS B 1512 • ISO 355 	<ul style="list-style-type: none"> • ABMA (includes metric J-series) 								
Basic number	Example, 30210 * T2EE040	Inner ring no. / outer ring no. ("J" appears at the beginning of the basic number in the case of J-series.)								

Table 1 (continued)

Type	Characteristics
<p>Single row tapered roller bearings</p>	<p>(4) These bearings are constructed to have a high capacity for radial loads, axial loads, and combined loads. The larger the contact angle, the greater the axial load capacity becomes. When a pure radial load is placed on the bearings, an induced load in the axial direction is also generated, and so these bearings are generally used in pairs arranged face to face.</p> <p>(5) When used in pairs, proper internal clearances and preload can be set by adjusting the distance between the two bearings' inner and outer rings.</p> <p>(6) Single row tapered roller bearings are separable, so both the inner and outer rings can be used with tight fits.</p> <p>(7) Tapered roller bearings are also manufactured with flanges attached to the outer rings. For more details, contact NTN Engineering. (Refer to Diagram 3)</p> <div data-bbox="1161 443 1485 779" style="text-align: center;">  <p>Diagram 3.</p> </div>
<p>Double row tapered roller bearings</p>	<p>(1) Back-to-back arrangement (using double row outer rings) and face-to-face arrangement (using double row inner rings) are both available, and they have been adjusted so that each type's internal clearance values are fixed. Therefore, only parts with identical manufacturing numbers can be used and they must be assembled according to their code numbers. (Refer to Diagram 4)</p> <p>(2) The axial internal clearances for double and duplex bearings are listed in Table 8, 9 on pages A-58.</p> <p>(3) Pairs of duplex single row tapered roller bearings are also manufactured. For more details, contact NTN Engineering.</p> <div data-bbox="1161 853 1485 1189" style="text-align: center;">  <p>Face-to-face Back-to-back</p> <p>Diagram 4.</p> </div>
<p>Four row tapered roller bearings</p>	<p>(1) As shown in Diagram 5, four row tapered roller bearings are constructed of two double row inner rings and two double row outer rings.</p> <p>(2) Life of large bearings is extended by using case hardened steel, hollow rollers and pin-type cages.</p> <p>(3) Used primarily where heavy load capacity is important, and in the roller necks of rolling mills.</p> <div data-bbox="1161 1234 1485 1503" style="text-align: center;">  <p>Diagram 5.</p> </div>

2. Standard cage type

In general, pressed cages are used in tapered roller bearings.

However, for large sized bearings, machined or pin type cages are also used; and for small sized bearings, molded resin cages are also used.

3. Allowable misalignment

Single row and back-to-back arrangement:0.0005rad (1.5') Face-to-face arrangement:0.001rad (3.5')

In situations where large displacement is necessary, please consult NTN Engineering.

4. Precautions when using

If bearing load is light during operation, or if the ratio of axial to radial load for duplex and double row bearings exceeds the value of e , slipping develops between the rollers and raceway, sometimes resulting in smearing. The mass of rollers and cages particularly tends to be large for large tapered roller bearings. For details, please contact NTN Engineering.

5. ECO-Top tapered roller bearings

In recent years, there has been an increasing demand for small and medium tapered roller bearings that contribute to energy savings, higher output, longer life, higher speed and more efficient assembly, particularly for automobiles. NTN Engineering is responding to this demand by providing bearings with special specifications based on 4Top tapered roller bearings, which are standard bearings.

In order to contribute to the ecology movement, in addition to enhancing existing special specifications, NTN Engineering has developed the next-generation NTN Engineering tapered roller bearing **ECO-Top tapered roller bearing** having improved long life, low torque, anti-seizure, easy assembly specifications. The features are as follows (compared with NTN Engineering standard bearings):

- (1) Ten times longer life using contaminated lubricant
- (2) Two times longer life using clean lubricant
- (3) At least 10% lower torque in practical rotation range
- (4) 25% better anti-seizure performance
- (5) Two times better loss-of-preload resistance
- (6) Half reduced number of revolutions to stable assembled bearing width

For details, please contact NTN Engineering.

چرخ صنعت کشور



Eco-Top tapered roller bearings

Inch series Tapered Roller Bearings (single row) index

Series number	Cone / cup number	Page of bearing dimension table
335	336/332	B-159
335	339/332	B-155
335	344/332	B-157
355	350A/354A	B-157
355	355/354A	B-159
355	358/354A	B-161
355	359A/354A	B-161
355	359S/352	B-161
365	365/362A	B-163
365	366/362A	B-163
365	367/362A	B-161
365	368/362A	B-163
365	368A/362	B-163
365	368S/362A	B-165
365	369A/362A	B-161
365	370A/362A	B-163
385	385/382A	B-167
385	385A/382A	B-167
385	386A/382A	B-161
385	387/382A	B-167
385	387A/382A	B-167
385	387A/382A	B-167
385	387S/382A	B-167
385	388A/382A	B-167
385	389/382A	B-167
385	389A/382A	B-165
395	390/394A	B-167
395	390A/394A	B-169
395	392/394A	B-169
395	395A/394A	B-171
395	396/394A	B-163
395	397/394A	B-169
395	399A/394A	B-171
415	418/414	B-157
415	420/414	B-157
435	436/432	B-161
435	438/432	B-159
455	455/453X	B-167
455	460/453X	B-159
455	462/453X	B-167
455	463/453X	B-161
455	469/453A	B-167
455	469/453X	B-167
455	469/454	B-167
475	477/472	B-169
475	480/472	B-171
475	482/472	B-171
475	483/472	B-169
475	484/472	B-173
495	495/493	B-175
495	495A/493	B-173
495	495AS/493	B-175
495	496/493	B-175
495	497/492A	B-177

Series number	Cone / cup number	Page of bearing dimension table
495	498/493	B-177
525	527/522	B-159
525	528/522	B-161
525	529/522	B-165
535	537/532X	B-165
535	539/532X	B-165
535	543/532X	B-157
555	555/552A	B-165
555	555S/552A	B-167
555	557S/552A	B-165
555	558/552A	B-169
555	559/552A	B-169
555	560/552A	B-171
555	560S/552A	B-171
565	565/563	B-169
565	566/563	B-171
565	567/563	B-173
565	567A/563	B-173
565	568/563	B-173
575	575/572	B-173
575	575S/572	B-173
575	576/572	B-173
575	577/572	B-173
575	580/572	B-175
575	581/572	B-175
575	582/572	B-175
595	593/592A	B-177
595	594/592A	B-179
595	594A/592XE	B-179
595	595/592A	B-175
595	596/592A	B-177
595	598A/592A	B-177
615	619/612	B-165
615	621/612	B-165
615	623/612	B-167
635	639/632	B-169
635	641/632	B-171
635	641/633	B-171
635	643/632	B-171
635	644/632	B-173
655	655/653	B-171
655	659/653	B-173
655	661/653	B-175
655	663/652	B-175
655	663/653	B-175
655	665/653	B-177
675	681/672	B-177
675	683/672	B-179
675	685/672	B-179
675	687/672	B-179
745	740/742	B-175
745	744/742	B-173
745	745A/742	B-171
745	748S/742	B-173

Series number	Cone / cup number	Page of bearing dimension table
745	749/742	B-177
745	749A/742	B-175
755	756A/752	B-175
755	757/752	B-175
755	758/752	B-177
755	759/752	B-177
755	760/752	B-177
775	780/772	B-179
775	782/772	B-179
795	799/792	B-181
795	799A/792	B-181
835	835/832	B-171
835	842/832	B-175
835	850/832	B-177
855	861/854	B-179
895	896/892	B-183
895	898/892	B-183
935	936/932	B-179
935	938/932	B-171
935	941/932	B-179
1200	1280/1220	B-147
1300	1380/1328	B-147
1300	1380/1329	B-147
1700	1755/1729	B-147
1700	1775/1729	B-147
1700	1779/1729	B-149
1700	1780/1729	B-149
1900	1985/1930	B-149
1900	1985/1931	B-151
1900	1985/1932	B-151
2400	2474/2420	B-151
2500	2558/2523	B-151
2500	2578/2523	B-151
2500	2580/2520	B-153
2500	2580/2523	B-153
2500	2582/2523	B-153
2500	2585/2523	B-153
2600	2682/2631	B-149
2600	2687/2631	B-149
2600	2688/2631	B-149
2600	2689/2631	B-151
2600	2690/2631	B-151
2700	2776/2720	B-157
2700	2780/2720	B-155
2700	2785/2720	B-153
2700	2788/2720	B-157
2700	2789/2720	B-157
2700	2793/2720	B-153
2700	2793/2729	B-155
2700	2793/2735X	B-153
2800	2878/2820	B-153
2800	2879/2820	B-153
2900	2984/2924	B-161
3100	3187/3120	B-151

Inch series Tapered Roller Bearings (single row) index

Series number	Cone / cup number	Page of bearing dimension table	Series number	Cone / cup number	Page of bearing dimension table	Series number	Cone / cup number	Page of bearing dimension table
3100	3188/3120	B-153	6500	6576/6535	B-175	15000	15112/15245	B-151
3100	3193/3120	B-153	6500	6580/6535	B-177	15000	15116/15245	B-151
3100	3196/3120	B-153	02400	02474/02420	B-151	15000	15117/15245	B-151
3300	3379/3320	B-155	02400	02475/02420	B-153	15000	15118/15245	B-151
3300	3382/3321	B-157	02400	02476/02420	B-153	15000	15119/15245	B-151
3300	3382/3339	B-157	02800	02872/02820	B-151	15000	15120/15245	B-151
3300	3386/3320	B-157	02800	02875/02820	B-153	15000	15123/15245	B-151
3400	3476/3420	B-153	02800	02877/02820	B-153	15000	15125/15245	B-151
3400	3478/3420	B-155	02800	02878/02820	B-153	15000	15126/15245	B-153
3400	3479/3420	B-155	03000	03062/03162	B-147	15500	15580/15523	B-149
3400	3490/3420	B-157	05000	05062/05185	B-147	15500	15590/15520	B-149
3500	3576/3525	B-159	05000	05066/05185	B-147	15500	15590/15523	B-151
3500	3578/3520	B-159	05000	05075/05185	B-147	16000	16137/16284	B-153
3500	3578/3525	B-159	05000	05079/05185	B-147	17000	16150/16282	B-155
3500	3579/3525	B-159	07000	07079/07196	B-147	17000	17118/17244	B-151
3500	3580/3525	B-157	07000	07087/07196	B-147	17000	17119/17244	B-151
3500	3586/3525	B-161	07000	07093/07196	B-149	17500	17580/17520	B-147
JS3500	JS3549A/JS3510	B-154	07000	07096/07196	B-149	18500	18590/18520	B-157
3700	3767/3720	B-165	07000	07097/07196	B-149	18600	18685/18620	B-159
3700	3775/3720	B-163	07000	07098/07196	B-149	18600	18690/18620	B-161
3700	3776/3720	B-161	07000	07100/07196	B-149	18700	18790/18720	B-163
3700	3777/3720	B-161	07000	07100/07204	B-149	18700	18790/18724	B-163
3700	3778/3720	B-161	07000	07100S/07196	B-149	19000	19150/19281	B-155
3700	3780/3720	B-163	09000	09062/09195	B-147	21000	21075/21212	B-147
3700	3780/3726	B-163	09000	09067/09195	B-147	22700	22780/22720	B-159
3700	3780/3732	B-163	09000	09067/09196	B-147	23000	23100/23256	B-149
3700	3781/3720	B-163	09000	09078/09195	B-147	24700	24780/24720	B-157
3700	3782/3720	B-159	09000	09081/09195	B-147	25500	25572/25520	B-157
3800	3872/3820	B-154	11000	11162/11300	B-157	25500	25577/25520	B-159
3800	3875/3820	B-157	11000	11162/11315	B-157	25500	25578/25520	B-159
3800	3880/3820	B-159	11500	11590/11520	B-147	25500	25580/25520	B-159
3900	3975/3920	B-165	LM11700	LM11749/LM11710	B-147	25500	25582/25520	B-159
3900	3979/3920	B-167	LM11900	LM11949/LM11910	B-147	25500	25584/25520	B-161
3900	3980/3920	B-169	12000	12175/12303	B-159	25500	25590/25519	B-161
3900	3982/3920	B-169	12500	12580/12520	B-147	25500	25590/25520	B-161
3900	3984/3925	B-171	M12600	M12648/M12610	B-147	25500	25590/25522	B-161
3900	3994/3920	B-171	M12600	M12649/M12610	B-147	25500	25590/25526	B-161
A4000	A4050/A4138	B-147	LM12700	LM12749/LM12711	B-147	25500	25592/25520	B-161
A4000	A4059/A4138	B-147	13600	13685/13621	B-155	25800	25877/25820	B-153
4300	4388/4335	B-159	13600	13687/13621	B-155	25800	25877/25821	B-153
4300	4395/4335	B-159	13800	13889/13830	B-155	25800	25880/25821	B-155
5300	5395/5335	B-163	14000	14116/14274	B-151	26800	26878/26822	B-157
5500	5578/5535	B-165	14000	14116/14276	B-151	26800	26880/26822	B-157
5500	5583/5535	B-169	14000	14117A/14276	B-151	26800	26882/26823	B-157
5500	5584/5535	B-169	14000	14124/14276	B-153	26800	26882/26824	B-159
5700	5760/5735	B-173	14000	14125A/14276	B-153	26800	26883/26822	B-155
A6000	A6075/A6157	B-147	14000	14130/14276	B-153	26800	26884/26822	B-159
6200	6277/6220	B-161	14000	14137A/14276	B-153	26800	26885/26822	B-157
6300	6379/6320	B-171	14000	14139/14276	B-155	27600	27687/27620	B-175
6300	6386/6320	B-171	15000	15100/15245	B-149	27600	27689/27620	B-175
6400	6460/6420	B-173	15000	15101/15243	B-149	27600	27690/27620	B-175
6400	6461/6420	B-175	15000	15102/15245	B-149	27600	27691/27620	B-175
6400	6461A/6420	B-173	15000	15103/15245	B-149	27800	27880/27820	B-157
6500	6559C/6535	B-175	15000	15106/15245	B-149	28000	28150/28300	B-157

Inch series Tapered Roller Bearings (single row) index

Series number	Cone / cup number	Page of bearing dimension table
28000	28150/28315	B-157
28000	28158/28300	B-157
28500	28579/28521	B-163
28500	28580/28521	B-163
28500	28584/28521	B-165
28600	28678/28622	B-163
28600	28680/28622	B-167
28600	28682/28622	B-167
28900	28985/28921	B-169
28900	28990/28920	B-169
28900	28995/28920	B-169
29500	29585/29520	B-169
29500	29585/29521	B-169
29500	29586/29520	B-169
29500	29590/29520	B-171
29600	29675/29620	B-171
29600	29675/29630	B-171
29600	29685/29620	B-173
29600	29688/29620	B-173
LM29700	LM29748/LM29710	B-155
31500	31593/31520	B-155
31500	31594/31520	B-155
31500	31597/31520	B-155
33000	33225/33462	B-167
33000	33275/33462	B-171
33000	33281/33462	B-173
33000	33287/33462	B-173
33800	33885/33821	B-159
33800	33889/33821	B-163
33800	33890/33821	B-165
33800	33895/33822	B-165
34000	34274/34478	B-171
34000	34300/34478	B-173
34000	34301/34478	B-173
34000	34306/34478	B-175
36600	36690/36620	B-183
36900	36990/36920	B-183
37000	37425/37625	B-179
37000	37431/37625	B-179
39500	39575/39520	B-165
39500	39580/39520	B-167
39500	39581/39520	B-167
39500	39585/39520	B-169
39500	39590/39520	B-171
41000	41125/41286	B-151
42000	42346/42584	B-177
42000	42350/42584	B-177
42000	42368/42584	B-177
42000	42375/42584	B-179
42000	42381/42584	B-179
42600	42687/42620	B-173
42600	42690/42620	B-175
43000	43131/43312	B-153
44000	44143/44348	B-155

Series number	Cone / cup number	Page of bearing dimension table
44000	44150/44348	B-157
44000	44158/44348	B-157
L44600	L44640/L44610	B-149
L44600	L44643/L44610	B-149
L44600	L44649/L44610	B-149
45200	45280/45220	B-161
45200	45282/45220	B-163
45200	45284/45220	B-165
45200	45287/45220	B-165
45200	45289/45220	B-167
L45400	L45449/L45410	B-151
46000	46162/46368	B-159
46000	46175/46368	B-159
46000	46780/46720	B-183
46000	46790/46720	B-183
47400	47487/47420	B-171
47400	47490/47420	B-173
47600	47678/47620	B-173
47600	47681/47620	B-175
47600	47686/47620	B-175
47800	47890/47820	B-177
47800	47896/47820	B-179
48200	48286/48220	B-181
48200	48290/48220	B-181
48300	48385/48320	B-183
48300	48393/48320	B-183
LM48500	LM48548/LM48510	B-153
LM48500	LM48548A/LM48510	B-153
48600	48684/48620	B-183
48600	48685/48620	B-183
49500	49585/49520	B-165
52000	52375/52618	B-179
52000	52387/52618	B-179
52000	52393/52618	B-179
52000	52400/52618	B-179
53000	53162/53375	B-159
53000	53177/53375	B-159
55000C	55175C/55437	B-161
55000C	55176C/55437	B-161
55000C	55187C/55437	B-163
55000C	55200C/55443	B-165
56000	56425/56650	B-179
59000	59200/59412	B-165
64000	64433/64700	B-181
64000	64450/64700	B-181
65000	65237/65500	B-169
65000	65390/65320	B-163
66000	66200/66462	B-165
66000	66225/66462	B-167
66000	66584/66520	B-165
66000	66589/66520	B-167
LM67000	LM67048/LM67010	B-151
67300	67388/67322	B-181
67300	67389/67322	B-181

Series number	Cone / cup number	Page of bearing dimension table
67300	67390/67322	B-183
67300	67391/67322	B-183
67700	67790/67720	B-183
68000	68450/68712	B-181
68000	68462/68712	B-181
L68100	L68149/L68111	B-155
L69300	JL69349/JL69310	B-155
71000	71453/71750	B-181
72000	72188/72487	B-163
72000C	72200C/72487	B-165
72000C	72212C/72487	B-165
72000C	72218C/72487	B-167
72000C	72225C/72487	B-167
LM72800	LM72849/LM72810	B-149
74000	74500/74850	B-181
74000	74525/74850	B-183
74000	74550/74850	B-183
78000	78225/78551	B-167
78000	78250/78551	B-169
78000C	78214C/78551	B-165
LM78300	LM78349/LM78310C	B-155
LM78300	LM78349A/LM78310A	B-155
M84500	M84548/M84510	B-149
M86600	M86643/M86610	B-149
M86600	M86647/M86610	B-151
M86600	M86649/M86610	B-151
M88000	M88048/M88010	B-153
HM88500	JHM88540/JHM88513	B-151
HM88500	HM88542/HM88510	B-153
HM88500	HM88542/HM88512	B-153
HM88500	HM88547/HM88510	B-153
HM88600	HM88648/HM88610	B-155
HM88600	HM88648/HM88611AS	B-155
HM88600	HM88649/HM88610	B-153
HM89400	HM89440/HM89410	B-153
HM89400	HM89443/HM89410	B-153
HM89400	HM89444/HM89410	B-153
HM89400	HM89446/HM89410	B-155
HM89400	HM89448/HM89410	B-155
HM89400	HM89449/HM89410	B-155
HM89400	HM89449/HM89411	B-155
90000	J90354/J90748	B-177
90000	90381/90744	B-179
95000	95475/95925	B-181
95000	95500/95905	B-181
95000	95525/95925	B-183
97000	97500/97900	B-181
99000	99550/99100	B-183
99000	99575/99100	B-183
LM102900	LM102949/LM102910	B-161
LM104900	JLM104948/JLM104910	B-163
LM104900	LM104947A/LM104911	B-163
LM104900	LM104949/LM104911	B-163
M205100	JM205149/JM205110	B-163

Inch series Tapered Roller Bearings (single row) index

Series number	Cone / cup number	Page of bearing dimension table
M207000	JM207049/JM207010	B-167
H211700	JH211749/JH211710	B-171
HM212000	HM212044/HM212011	B-169
HM212000	HM212046/HM212011	B-169
HM212000	HM212049/HM21210	B-171
L217800	L217849/L217810	B-177
LL217800	LL217849/LL217810	B-177
HM218200	HM218248/HM218210	B-177
HH221400	HH221430/HH221410	B-175
HH221400	HH221431/HH221410	B-175
HH221400	HH221440/HH221410	B-179
HH221400	HH221449/HH221410	B-179
HH221400	HH221449A/HH221410	B-179
HH224300	HH224334/HH224310	B-179
HH224300	HH224335/HH224310	B-179
HH224300	HH224346/HH224310	B-181
HH228300	HH228349/HH228310	B-181
M231600	M231648/M231610	B-183
LM300800	LM300849/LM300811	B-157
H307700	JH307749/JH307710	B-167
HM318400	JHM318448/JHM318410	B-177
L319200	L319249/L319210	B-179
L327200	L327249/L327210	B-181
H414200	H414242/H414210	B-171
H414200	H414245/H414210	B-171
H414200	H414249/H414210	B-173
H415600	JH415647/JH415610	B-173
L432300	L432349/L432310	B-183
LM501300	LM501349/LM501310	B-157
LM501300	LM501349/LM501314	B-157
LM503300	LM503349A/LM503310	B-161
HH506300	HH506348/HH506310	B-163
HH506300	HH506349/HH506310	B-163
LM506800	JLM506849/JLM506810	B-165
LM508700	JLM508748/JLM508710	B-167
M511900	JM511946/JM511910	B-169
M515600	JM515649/JM515610	B-175
HM516400	HM516442/HM516410	B-173
HM516400	HM516448/HM516410	B-175
HM516800	JHM516849/JHM516810	B-177
LM522500	LM522546/LM522510	B-179
LM522500	LM522548/LM522510	B-181
HM522600	JHM522649/JHM522610	B-181
HM534100	JHM534149/JHM534110	B-183
LM603000	LM603049/LM603011	B-164
L610500	L610549/L610510	B-169
M612900	JM612949/JM612910	B-171
HM617000	HM617049/HM617010	B-177
L630300	L630349/L630310	B-183
LL639200	LL639249/L639210	B-183
LM704600	JLM704649/JLM704610	B-163
LM710900	JLM710949/JLM710910	B-169
LM714100	JLM714149/JLM714110	B-173
M714200	JM714249/JM714210	B-173

Series number	Cone / cup number	Page of bearing dimension table
H715300	H715334/H715311	B-169
H715300	H715343/H715311	B-171
H715300	H715345/H715311	B-173
H715300	H715348/H715311	B-175
M716600	JM716648/JM716610	B-177
M718100	JM718149/JM718110	B-177
M719100	JM719149/JM719113	B-177
M720200	JM720249/JM720210	B-179
L724300	JL724348/JL724314	B-181
M736100	JM736149/JM736110	B-183
M738200	JM738249/JM738210	B-183
HM801300	HM801346/HM801310	B-157
HM801300	HM801349/HM801310	B-157
M802000	M802048/M802011	B-159
HM803100	HM803145/HM803110	B-159
HM803100	HM803149/HM803110	B-159
M804000	M804048/M804010	B-161
M804800	M804846/M804810	B-161
M804800	M804848/M804810	B-163
M804800	M804849/M804810	B-163
HM804800	HM804840/HM804810	B-159
HM804800	HM804842/HM804810	B-159
LM806600	LM806649/LM806610	B-165
HM807000	HM807040/HM807010	B-161
HM807000	HM807044/HM807010	B-163
HM807000	HM807046/HM807010	B-163
HM807000	HM807048/HM807010	B-165
HM807000	HM807049/HM807010	B-165
HM807000	JHM807045/JHM807012	B-163
L812100	L812148/L812111	B-171
LM813000	JLM813049/JLM813010	B-171
HM813800	HM813840/HM813810	B-167
HM813800	HM813841/HM813810	B-169
HM813800	HM813842/HM813810	B-169
HM813800	HM813844/HM813810	B-171
L814700	L814749/L814710	B-173
LM814800	LM814849/LM814810	B-175
M822000	JM822049/JM822010	B-181
HM903200	HM903245/HM903210	B-159
HM903200	HM903249/HM903210	B-159
M903300	M903345/M903310	B-159
HM907600	HM907643/HM907614	B-165
HM911200	HM911242/HM911210	B-165
HM911200	HM911245/HM911210	B-169
HM911200	HM911244/JHM911211	B-169
H913800	H913840/H913810	B-167
H913800	H913842/H913810	B-169
H913800	JH913848/JH913811	B-173
H917800	H917840/H917810	B-175
H924000	H924045/H924010	B-181
HM926700	HM926740/HM926710	B-181
HM926700	HM926747/HM926710	B-181

Inch series Tapered Roller Bearings (four row) index

Series number	Cone / cup number	Page of bearing dimension table	Series number	Cone / cup number	Page of bearing dimension table
8500	T-8576D/8520/8520D	B-205	M263300	M263349D/M263310/M263310D	B-209
46700	46791D/46720/46721D	B-203	HM265000	HM265049D/HM265010/HM265010D	B-211
48200	T-48290D/48220/48220D	B-203	HM266400	T-HM266449D/HM266410/HM266410DG2	B-211
48300	T-48393D/48320/48320D	B-203	M268700	T-M268749D/M268710/M268710DG2	B-211
48600	T-48680D/48620/48620D	B-203	M270700	M270749D/M270710/M270710DAG2	B-211
67700	67791D/67720/67721D	B-203	LM272200	LM272249D/LM272210/LM272210DG2	B-213
67800	T-67885D/67820/67820D	B-205	M274100	M274149D/M274110/M274110DG2	B-213
81000	81576D/81962/81963D	B-203	LM274400	LM274449D/LM274410/LM274410D	B-213
82600	82681D/82620/82620D	B-203	275000	EE275106D/275155/275156D	B-207
126000	EE126096D/126150/126151D	B-205	275000	EE275109D/275160/275161D	B-207
127000	EE127097D/127137/127137D	B-205	M275300	M275349D/M275310/M275310DG2	B-213
132000	EE132082D/132125/132126D	B-205	M276400	M276449D/M276410/M276410DG2	B-213
134000	EE134102D/134143/134144D	B-207	M278700	M278749D/M278710/M278710DAG2	B-213
L163100	L163149D/L163110/L163110D	B-209	LM278800	LM278849D/LM278710/LM278710D	B-215
170000	EE171000D/171450/17145D	B-205	280000	EE280700D/281200/281201D	B-203
220000	EE221027D/221575/221576D	B-207	M280000	M280049D/M280010/M280010DG2	B-215
M224700	M224749D/M224710/M224710D	B-203	L281100	L281149D/L281110/L281110DG2	B-215
M231600	T-M231649D/M231610/M231610D	B-203	M281600	M281649D/M281610/M281610DG2	B-215
M238800	M238849D/M238810/M238810D	B-203	LM281800	LM281849D/LM281810/LM281810DG2	B-215
M241500	M241538D/M241510/M241510D	B-205	M282200	M282249D/M282210/M282210DG2	B-215
M244200	T-M244249D/M244210/M244210D	B-205	M283400	M283449D/M283410/M283410DG2	B-215
LM247700	LM247748D/LM247710/LM247710DA	B-205	LM283600	LM283649D/LM283610/LM283610DG2	B-215
M249700	T-M249748D/M249710/M249710D	B-205	M284200	M284249D/M284210/M284210DG2	B-215
HM252300	HM252349D/HM252310/HM252310D	B-207	M285800	M285848D/M285810/M285810DG2	B-215
M252300	T-M252349D/M252310/M252310D	B-207	LM286200	LM286249D/LM286210/LM286210DG2	B-217
M255400	M255449D/M255410/M255410DA	B-207	LM287600	LM287649D/LM287610/LM287610DG2	B-217
HM256800	T-HM256849D/HM256810/HM256810DG2	B-207	LM288900	LM288949D/LM288910/LM288910DG2	B-217
M257100	M257149D/M257110/M257110D	B-207	290000	EE291202D/291750/291751D	B-207
M257200	M257248D/M257210/M257210D	B-209	329000	EE329119D/329172/329173D	B-207
LM258600	LM258649D/LM258610/LM258610D	B-209	LM377400	LM377449D/LM377410/LM377410DG2	B-213
HM259000	T-HM259049D/HM259010/HM259010D	B-209	LM451300	T-LM451349D/LM451310/LM451310D	B-207
HM261000	HM261049D/HM261010/HM261010DA	B-209	526000	EE526131D/526190/52619D	B-209
M262400	M262449D/M262410/M262410D	B-209	547000	EE547341D/547480/547481DG2	B-217
HM262700	T-HM262749D/HM262710/HM262710DG2	B-209	640000	T-EE640193D/640260/640261DG2	B-203
LM263100	LM263149D/LM263110/LM263110D	B-209	649000	EE649241D/649310/649311DG2	B-215

Inch series Tapered Roller Bearings (four row) index

Series number	Cone / cup number	Page of bearing dimension table
LM654600	T-LM654644D/LM654610/LM654610D	B-207
LM654600	T-LM654648D/LM654610/LM654610D	B-207
655000	EE655271D/655345/655346DG2	B-215
LM665900	LM665949D/LM665910/LM665910D	B-211
M667900	M667947D/M667911/M667911DG2	B-211
700000	EE700090D/700167/700168D	B-205
LM742700	T-LM742749D/LM742714/LM742714D	B-205
755000	EE755281D/755360/755361DG2	B-215
M757400	M757448D/M757410/M757410D	B-207
M757400	M757449D/M757410/M757410D	B-209
LM761600	LM761648D/LM761610/LM761610D	B-209
LM761600	LM761649D/LM761610/LM761610D	B-209
LM763400	LM763449D/LM763410/LM763410D	B-209
LM765100	LM765149D/LM765110/LM765110D	B-211
LM767700	LM767745D/LM767710/LM767710D	B-211
LM767700	LM767749D/LM767710/LM767710D	B-211
LM769300	LM769349D/LM769310/LM769310D	B-211
L770800	L770849D/L770810/L770810DG2	B-213
LM772700	LM772749D/LM772710/LM772710DA	B-213
LM778500	LM778549D/LM778510/LM778510DG2	B-215
822000	EE822101D/822175/822176D	B-205
833000	EE833161D/833232/833233D	B-211
843000	EE843221D/843290/843291D	B-213
LM869400	T-LM869449D/LM869410/LM869410DG2	B-211
910000	EE911603D/912400/912401D	B-211
920000	EE921150D/921875/921876D	B-207
970000	EE971355D/972100/972103D	B-209



Metric series

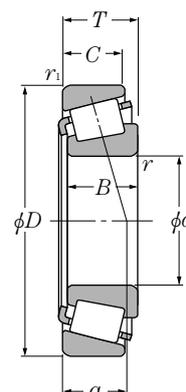

d 15 ~ 30mm

d	Boundary dimensions						Basic load ratings				Limiting speeds		Bearing numbers	
	D	T	mm			$r_{1s \min}^{1)}$	$r_{1s \min}^{1)}$	dynamic	static	dynamic	static	grease		oil
			B	C	r_1			C _r	C _{or}	C _r	C _{or}			
15	42	14.25	13	11	1	1	23.2	20.8	2 370	2 120	9 900	13 000	4T-30302	
17	40	13.25	12	11	1	1	20.5	20.3	2 090	2 070	9 900	13 000	4T-30203	
	40	17.25	16	14	1	1	27.3	28.3	2 790	2 880	9 900	13 000	4T-32203	
	40	17.25	16	14	1	1	26.2	28.2	2 670	2 870	9 900	13 000	4T-32203R ²⁾	
	47	15.25	14	12	1	1	28.9	26.3	2 940	2 680	9 000	12 000	4T-30303	
20	42	15	15	12	0.6	0.6	24.9	27.9	2 540	2 840	9 500	13 000	4T-32004X	
	47	15.25	14	12	1	1	28.2	28.7	2 870	2 930	8 800	12 000	4T-30204	
	47	19.25	18	15	1	1	36.5	39.5	3 700	4 000	8 800	12 000	4T-32204	
	52	16.25	16	13	1.5	1.5	35.5	34.0	3 600	3 450	8 000	11 000	4T-30304A	
	52	16.25	16	12	1.5	1.5	31.0	31.0	3 150	3 150	7 600	10 000	4T-30304CA	
52	22.25	21	18	1.5	1.5	46.5	48.5	4 750	4 950	8 000	11 000	4T-32304		
22	44	15	15	11.5	0.6	0.6	27.0	31.5	2 760	3 250	8 900	12 000	4T-320/22X	
25	47	15	15	11.5	0.6	0.6	27.8	33.5	2 830	3 450	7 900	11 000	4T-32005X	
	47	17	17	14	0.6	0.6	32.5	40.5	3 300	4 150	8 000	11 000	4T-33005	
	52	16.25	15	13	1	1	31.5	34.0	3 200	3 450	7 300	9 800	4T-30205	
	52	19.25	18	16	1	1	42.0	47.0	4 300	4 800	7 300	9 800	4T-32205	
	52	19.25	18	15	1	1	38.0	43.0	3 850	4 400	7 300	9 800	4T-32205R ²⁾	
	52	19.25	18	15	1	1	38.0	46.5	3 900	4 750	7 100	9 400	4T-32205C	
	52	19.25	18	15	1	1	34.5	42.0	3 500	4 250	7 100	9 400	4T-32205CR ²⁾	
	52	22	22	18	1	1	47.5	57.5	4 850	5 850	7 300	9 800	4T-33205	
	62	18.25	17	15	1.5	1.5	48.5	47.5	4 950	4 850	6 700	8 900	4T-30305	
	62	18.25	17	14	1.5	1.5	41.5	41.5	4 250	4 250	6 400	8 500	4T-30305C	
62	18.25	17	13	1.5	1.5	40.5	43.5	4 150	4 450	5 900	7 800	4T-30305D		
62	25.25	24	20	1.5	1.5	61.5	64.5	6 250	6 600	6 700	8 900	4T-32305		
28	52	16	16	12	1	1	33.0	40.5	3 400	4 150	7 300	9 700	4T-320/28X	
	58	24	24	19	1	1	58.0	69.5	5 950	7 100	6 700	8 900	4T-332/28	
30	55	17	17	13	1	1	37.5	46.0	3 800	4 700	6 900	9 200	4T-32006X	
	55	20	20	16	1	1	42.5	54.0	4 300	5 500	6 900	9 200	4T-33006	
	62	17.25	16	14	1	1	43.5	48.0	4 450	4 900	6 300	8 400	4T-30206	
	62	21.25	20	17	1	1	54.5	64.0	5 600	6 550	6 300	8 400	4T-32206	
	62	21.25	20	17	1	1	50.0	60.0	5 100	6 100	6 100	8 100	4T-32206C	
	62	25	25	19.5	1	1	65.0	77.0	6 600	7 850	6 300	8 400	4T-33206	
72	20.75	19	16	1.5	1.5	60.0	61.0	6 100	6 200	5 700	7 600	4T-30306		

1) Minimal allowable dimension for chamfer dimension r or r_1 .
 2) This bearing does not incorporate the subunit dimensions.

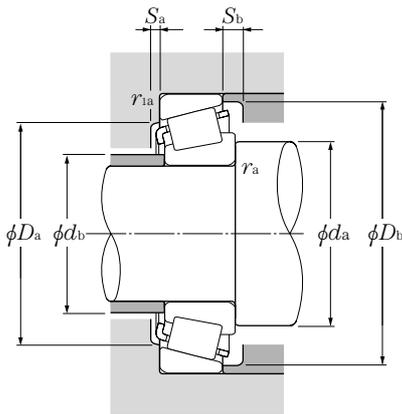

Equivalent radial load dynamic

$$P_r = X F_r + Y F_a$$

$\frac{F_a}{F_r} \leq e$		$\frac{F_a}{F_r} > e$	
X	Y	X	Y
1	0	0.4	Y ₂

static

$$P_{or} = 0.5 F_r + Y_o F_a$$

When $P_{or} < F_r$ use $P_{or} = F_r$

For values of e , Y_2 and Y_o see the table below.

Dimensions series to ISO	Abutment and fillet dimensions										Load center mm	Constant e	Axial load factors		Mass kg (approx.)
	d_a min	d_b max	D_a max	D_b min	S_a min	S_b min	r_{as} max	r_{1as} max	Y_2	Y_o					
2FB	20.5	22	36.5	35	38	2	3	1	1	9.5	0.29	2.11	1.16	0.098	
2DB	22.5	23	34.5	33	37	2	2	1	1	9.5	0.35	1.74	0.96	0.08	
2DD	22.5	23	34.5	33	37	2	3	1	1	11.5	0.31	1.92	1.06	0.102	
	22.5	22	34.5	33	36.5	2	3	1	1	11	0.35	1.74	0.96	0.104	
2FB	22.5	24	41.5	40	42	3	3.5	1	1	10.5	0.29	2.11	1.16	0.134	
3CC	24.5	25	37.5	36	39	3	3	0.6	0.6	10.5	0.37	1.60	0.88	0.097	
2DB	25.5	27	41.5	40	44	2	3	1	1	11.5	0.35	1.74	0.96	0.127	
2DD	25.5	26	41.5	39	43	2	4	1	1	12.5	0.33	1.81	1.00	0.16	
2FB	28.5	28	43.5	42.5	47.5	3	3	1.5	1.5	10.5	0.30	2.00	1.10	0.176	
	28.5	27.5	43.5	39.5	48	3	4	1.5	1.5	13.5	0.55	1.10	0.60	0.17	
2FD	28.5	27	43.5	43	47	3	4	1.5	1.5	14	0.30	2.00	1.10	0.245	
3CC	26.5	27	39.5	38	41	3	3.5	0.6	0.6	11	0.40	1.51	0.83	0.106	
4CC	29.5	30	42.5	40	44	3	3.5	0.6	0.6	12	0.43	1.39	0.77	0.114	
2CE	29.5	29	42.5	40	43.5	3	3	0.6	0.6	11	0.29	2.07	1.14	0.13	
3CC	30.5	31	46.5	44	48	2	3	1	1	12.5	0.37	1.60	0.88	0.154	
2CD	30.5	31	46.5	43	49.5	2	4	1	1	14	0.36	1.67	0.92	0.187	
	30.5	31	46.5	43	48	2	4	1	1	13.5	0.37	1.60	0.88	0.181	
5CD	30.5	30	46.5	42	49	2	4	1	1	16	0.58	1.03	0.57	0.19	
	30.5	30	46.5	42	49	2	4	1	1	16	0.55	1.10	0.60	0.19	
2DE	30.5	30	46.5	43	49	4	4	1	1	14	0.35	1.71	0.94	0.217	
2FB	33.5	34	53.5	52	57	3	3	1.5	1.5	13	0.30	2.00	1.10	0.272	
	33.5	34	53.5	48	58	3	4	1.5	1.5	16	0.55	1.10	0.60	0.264	
7FB	33.5	34	53.5	45.5	58.5	3	5	1.5	1.5	20	0.83	0.73	0.40	0.284	
2FD	33.5	32	53.5	52	57	3	5	1.5	1.5	16	0.30	2.00	1.10	0.381	
4CC	33.5	33	46.5	45	49	3	4	1	1	12.5	0.43	1.39	0.77	0.146	
2DE	33.5	34	52.5	49	55	5	5	1	1	15.5	0.34	1.77	0.97	0.293	
4CC	35.5	35	49.5	48	52	3	4	1	1	13.5	0.43	1.39	0.77	0.166	
2CE	35.5	35.5	49.5	46.5	52	3	4	1	1	13	0.29	2.06	1.13	0.201	
3DB	35.5	37	56.5	53	57	2	3	1	1	13.5	0.37	1.60	0.88	0.241	
3DC	35.5	37	56.5	52	58	2.5	4	1	1	15.5	0.37	1.60	0.88	0.301	
5DC	35.5	35	56.5	49	59.5	2	5	1	1	18.5	0.56	1.07	0.59	0.294	
2DE	35.5	36	56.5	53	59	5	5.5	1	1	16	0.34	1.76	0.97	0.344	
2FB	38.5	40	63.5	62	66	3	4.5	1.5	1.5	15	0.31	1.90	1.05	0.408	

Metric series

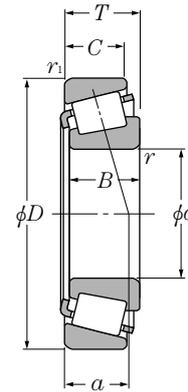

d 30 ~ 45mm

d	Boundary dimensions						Basic load ratings				Limiting speeds		Bearing numbers
	D	T	mm			dynamic	static	dynamic	static	min ⁻¹			
			B	C	r _{s min} ¹⁾	r _{ls min} ¹⁾	C _r	C _{or}	C _r	C _{or}	grease	oil	
30	72	20.75	19	15	1.5	1.5	58.5	58.5	6 000	5 950	5 500	7 300	4T-30306CA
	72	20.75	19	14	1.5	1.5	48.5	51.5	4 950	5 250	5 000	6 700	4T-30306D
	72	28.75	27	23	1.5	1.5	81.0	90.0	8 250	9 150	5 700	7 600	4T-32306
	72	28.75	27	23	1.5	1.5	79.0	94.0	8 050	9 550	5 500	7 300	* 4T-32306C
	72	28.75	27	23	1.5	1.5	70.0	88.5	7 150	9 050	5 500	7 300	4T-32306CR ²⁾
32	58	17	17	13	1	1	37.0	46.5	3 750	4 750	6 600	8 700	4T-320/32X
	65	26	26	20.5	1	1	70.5	85.0	7 200	8 650	6 000	8 000	4T-332/32
	75	29.75	28	23	1.5	1.5	84.0	102	8 600	10 400	5 200	6 900	4T-323/32C
35	55	14	14	11.5	0.6	0.6	27.4	37.5	2 790	3 850	6 800	9 000	32907XU
	62	18	18	14	1	1	41.5	52.5	4 250	5 350	6 100	8 100	4T-32007X
	62	21	21	17	1	1	50.5	66.5	5 150	6 800	6 100	8 100	4T-33007
	72	18.25	17	15	1.5	1.5	55.5	61.5	5 650	6 250	5 500	7 400	4T-30207
	72	24.25	23	19	1.5	1.5	72.5	87.0	7 400	8 900	5 500	7 400	4T-32207
	72	24.25	23	19	1.5	1.5	68.0	85.5	6 950	8 750	5 300	7 100	4T-32207C
	72	24.25	23	18	1.5	1.5	62.0	78.5	6 300	8 000	5 300	7 100	4T-32207CR ²⁾
	72	28	28	22	1.5	1.5	87.5	109	8 900	11 200	5 500	7 400	4T-33207
	80	22.75	21	18	2	1.5	75.0	77.0	7 650	7 900	5 000	6 600	4T-30307
	80	22.75	21	17	2	1.5	66.5	68.5	6 750	7 000	4 800	6 400	4T-30307C
	80	22.75	21	15	2	1.5	63.5	70.0	6 450	7 100	4 400	5 800	4T-30307D
40	62	15	15	12	0.6	0.6	32.5	48.0	3 350	4 900	5 900	7 800	32908XU
	68	19	19	14.5	1	1	50.0	65.5	5 100	6 650	5 300	7 100	4T-32008X
	68	22	22	18	1	1	59.5	82.5	6 050	8 400	5 300	7 100	4T-33008
	75	26	26	20.5	1.5	1.5	79.5	103	8 100	10 500	5 200	6 900	4T-33108
	80	19.75	18	16	1.5	1.5	61.0	67.0	6 250	6 850	4 900	6 600	4T-30208
	80	24.75	23	19	1.5	1.5	79.5	93.5	8 100	9 550	4 900	6 600	4T-32208
	80	32	32	25	1.5	1.5	103	132	10 500	13 400	4 900	6 600	4T-33208
	85	33	32.5	28	2.5	2	118	144	12 000	14 700	4 600	6 200	4T-T2EE040
	90	25.25	23	20	2	1.5	91.5	102	9 350	10 400	4 400	5 900	4T-30308
	90	25.25	23	19	2	1.5	83.0	87.0	8 450	8 900	4 200	5 600	4T-30308C
	90	25.25	23	17	2	1.5	77.0	85.5	7 850	8 700	3 900	5 200	4T-30308D
45	68	15	15	12	0.6	0.6	33.5	51.5	3 450	5 250	5 300	7 000	* 32909XU
	90	35.25	33	27	2	1.5	122	150	12 500	15 300	4 400	5 900	32308U
	90	35.25	33	27	2	1.5	110	140	11 300	14 300	4 200	5 600	4T-32308C

1) Minimal allowable dimension for chamfer dimension r or r_1 . 2) This bearing does not incorporate the subunit dimensions.
 Note: When selecting bearings with bearing numbers marked with " * ", please consult NTN Engineering.

Tapered Roller Bearings

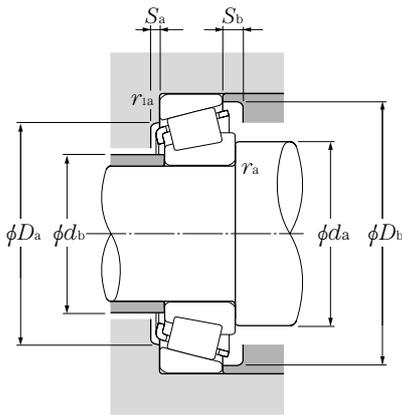

Equivalent radial load dynamic

$$P_r = X F_r + Y F_a$$

$\frac{F_a}{F_r} \leq e$		$\frac{F_a}{F_r} > e$	
X	Y	X	Y
1	0	0.4	Y_2

static

$$P_{or} = 0.5 F_r + Y_o F_a$$

When $P_{or} < F_r$ use $P_{or} = F_r$

For values of e , Y_2 and Y_o see the table below.

Dimensions series to ISO	Abutment and fillet dimensions									Load center mm	Constant e	Axial load factors		Mass kg (approx.)
	d_a	d_b	D_a	D_b	S_a	S_b	r_{as}	r_{1as}	Y_2			Y_o		
	min	max	max	min	min	min	max	max						
	38.5	39.5	63.5	57	67	3	5.5	1.5	1.5	17.5	0.47	1.27	0.70	0.398
7FB	38.5	39	63.5	55	68	3	6.5	1.5	1.5	23.5	0.83	0.73	0.40	0.398
2FD	38.5	38	63.5	59	66	3	5.5	1.5	1.5	18.5	0.31	1.90	1.05	0.583
5FD	38.5	37	63.5	57	68	2	5.5	1.5	1.5	23	0.55	1.10	0.60	0.592
	38.5	37	63.5	57	67.5	2	5.5	1.5	1.5	23	0.61	0.99	0.54	0.594
4CC	37.5	38	52.5	50	55	3	4	1	1	14.5	0.45	1.32	0.73	0.181
2DE	37.5	38	59.5	55	62	5	5.5	1	1	17	0.35	1.73	0.95	0.395
5FD	40.5	39	66.5	61	71	3	6.5	1.5	1.5	23	0.55	1.10	0.60	0.659
2BD	39.5	40	50.5	48	52.5	2.5	2.5	0.6	0.6	10.5	0.29	2.06	1.13	0.121
4CC	40.5	40	56.5	54	59	4	4	1	1	15.5	0.45	1.32	0.73	0.224
2CE	40.5	40.5	56.5	52	59	3	4	1	1	14	0.31	1.97	1.08	0.263
3DB	43.5	44	63.5	62	67	3	3	1.5	1.5	15	0.37	1.60	0.88	0.344
3DC	43.5	43	63.5	61	67	3	5	1.5	1.5	17.5	0.37	1.60	0.88	0.457
5DC	43.5	42	63.5	59	68	3	6	1.5	1.5	21.5	0.58	1.03	0.57	0.461
	43.5	42	63.5	59	68	3	6	1.5	1.5	20.5	0.55	1.10	0.60	0.461
2DE	43.5	42	63.5	61	68	5	6	1.5	1.5	18.5	0.35	1.70	0.93	0.531
2FB	45	45	71.5	70	74	3	4.5	2	1.5	17	0.31	1.90	1.05	0.540
	45	44	71.5	63.5	75.5	3	5.5	2	1.5	20.5	0.55	1.10	0.60	0.517
7FB	45	44	71.5	62	76.5	3	7.5	2	1.5	26	0.83	0.73	0.40	0.530
2FE	45	43	71.5	66	74	3	7.5	2	1.5	20.5	0.31	1.90	1.05	0.787
5FE	45	43	71.5	66	76	3	7.5	2	1.5	25	0.55	1.10	0.60	0.797
2BC	44.5	45.5	57.5	54	58.5	3	3	0.6	0.6	11.5	0.29	2.07	1.14	0.161
3CD	45.5	46	62.5	60	65	4	4.5	1	1	15	0.38	1.58	0.87	0.273
2BE	45.5	46	62.5	60	64	2.5	4	1	1	15	0.28	2.12	1.17	0.312
2CE	48.5	47	66.5	65	71	4	5.5	1.5	1.5	18	0.36	1.69	0.93	0.494
3DB	48.5	49	71.5	69	75	3	3.5	1.5	1.5	16.5	0.37	1.60	0.88	0.435
3DC	48.5	48	71.5	68	75	3	5.5	1.5	1.5	19	0.37	1.60	0.88	0.558
2DE	48.5	47	71.5	67	76	5	7	1.5	1.5	21	0.36	1.68	0.92	0.728
2EE	52	48	75	70	80	5	5	2	2	22.5	0.34	1.74	0.96	0.907
2FB	50	52	81.5	77	82	3	5	2	1.5	19.5	0.35	1.74	0.96	0.769
	50	50	80	72	85.5	3.5	6	2	1.5	23	0.55	1.10	0.60	0.728
7FB	50	50	81.5	71	86.5	3	8	2	1.5	29.5	0.83	0.73	0.40	0.738
2FD	50	50	81.5	73	82	3	8	2	1.5	23	0.35	1.74	0.96	1.08
5FD	50	48	81.5	72	84	3	8	2	1.5	27.5	0.55	1.10	0.60	1.1
2BC	50	50	63.5	59.5	64.5	3	3	0.6	0.6	12	0.32	1.88	1.04	0.188

Metric series

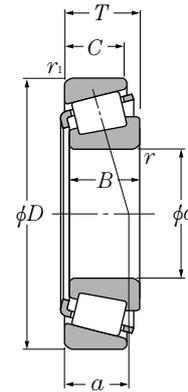

d 45 ~ 60mm

d	Boundary dimensions						Basic load ratings				Limiting speeds		Bearing numbers
	D	T	mm		$r_{s \min}^{1)}$	$r_{1s \min}^{1)}$	dynamic	static	dynamic	static	grease	oil	
	C_r	C_{or}	C_r	C_{or}			min ⁻¹						
			B	C			kN		kgf				
45	75	20	20	15.5	1	1	57.5	76.5	5 850	7 800	4 800	6 400	4T-32009X
	75	24	24	19	1	1	66.0	93.5	6 750	9 550	4 800	6 400	4T-33009
	80	26	26	20.5	1.5	1.5	84.5	115	8 650	11 700	4 700	6 200	4T-33109
	85	20.75	19	16	1.5	1.5	67.5	78.5	6 900	8 000	4 400	5 900	4T-30209
	85	24.75	23	19	1.5	1.5	82.0	100	8 350	10 200	4 400	5 900	4T-32209
	85	32	32	25	1.5	1.5	107	141	10 900	14 400	4 400	5 900	4T-33209
	100	27.25	25	22	2	1.5	111	126	11 300	12 800	4 000	5 300	4T-30309
	100	27.25	25	18	2	1.5	96.0	109	9 800	11 100	3 500	4 600	4T-30309D
	100	38.25	36	30	2	1.5	154	191	15 700	19 500	4 000	5 300	32309U
50	72	15	15	12	0.6	0.6	35.5	57.0	3 650	5 800	4 700	6 300	* 32910XU
	72	15	14	12	0.6	0.6	31.5	50.5	3 200	5 150	4 700	6 300	32910 ²⁾
	80	20	20	15.5	1	1	62.5	88.0	6 400	9 000	4 400	5 800	4T-32010X
	80	24	24	19	1	1	69.5	103	7 100	10 500	4 400	5 800	4T-33010
	85	26	26	20	1.5	1.5	86.5	121	8 850	12 400	4 200	5 600	4T-33110
	90	21.75	20	17	1.5	1.5	77.0	93.0	7 850	9 450	4 000	5 300	4T-30210
	90	24.75	23	19	1.5	1.5	87.5	109	8 900	11 100	4 000	5 300	4T-32210
	90	32	32	24.5	1.5	1.5	115	158	11 700	16 100	4 000	5 300	4T-33210
	100	36	35	30	2.5	2.5	151	190	15 400	19 400	3 800	5 100	4T-T2ED050
	105	32	29	22	3	3	107	132	10 900	13 500	3 400	4 500	4T-T7FC050
	110	29.25	27	23	2.5	2	133	152	13 500	15 500	3 600	4 800	4T-30310
110	29.25	27	19	2.5	2	113	130	11 600	13 300	3 200	4 200	4T-30310D	
	110	42.25	40	33	2.5	2	184	232	18 700	23 600	3 600	4 800	32310U
55	80	17	17	14	1	1	44.5	73.5	4 550	7 500	4 300	5 700	32911XU
	90	23	23	17.5	1.5	1.5	80.5	118	8 200	12 000	4 000	5 400	4T-32011X
	90	27	27	21	1.5	1.5	91.5	138	9 350	14 100	4 000	5 400	4T-33011
	95	30	30	23	1.5	1.5	111	155	11 300	15 800	3 900	5 200	4T-33111
	100	22.75	21	18	2	1.5	93.0	111	9 500	11 300	3 600	4 900	4T-30211
	100	26.75	25	21	2	1.5	108	134	11 000	13 700	3 600	4 900	4T-32211
	100	35	35	27	2	1.5	138	188	14 100	19 100	3 600	4 900	4T-33211
	120	31.5	29	25	2.5	2	155	179	15 800	18 300	3 300	4 400	4T-30311
	120	31.5	29	21	2.5	2	132	154	13 500	15 700	2 900	3 800	4T-30311D
	120	45.5	43	35	2.5	2	215	275	21 900	28 000	3 300	4 400	32311U
60	85	17	17	14	1	1	51.0	83.0	5 200	8 450	4 000	5 300	32912XA ²⁾
	95	23	23	17.5	1.5	1.5	82.0	123	8 350	12 500	3 700	4 900	4T-32012X
	95	27	27	21	1.5	1.5	93.5	145	9 550	14 700	3 700	4 900	4T-33012
	100	30	30	23	1.5	1.5	113	164	11 600	16 700	3 600	4 700	4T-33112

1) Minimal allowable dimension for chamfer dimension r or r_1 .
 2) This bearing does not incorporate the subunit dimensions.

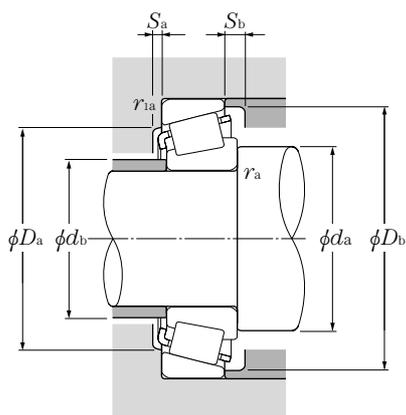

Equivalent radial load dynamic

$$P_r = X F_r + Y F_a$$

$\frac{F_a}{F_r} \leq e$		$\frac{F_a}{F_r} > e$	
X	Y	X	Y
1	0	0.4	Y ₂

static

$$P_{or} = 0.5 F_r + Y_o F_a$$

When $P_{or} < F_r$ use $P_{or} = F_r$

For values of e , Y_2 and Y_o see the table below.

Dimensions series to ISO	Abutment and fillet dimensions										Load center mm	Constant e	Axial load factors		Mass kg (approx.)
	d_a	d_b	D_a	D_b	S_a	S_b	r_{as}	r_{ias}	Y_2	Y_o					
	min	max	max	min	min	min	max	max							
3CC	50.5	51	69.5	67	72	4	4.5	1	1	16.5	0.39	1.53	0.84	0.346	
2CE	50.5	51	69.5	67	71	4	5	1	1	16	0.29	2.04	1.12	0.398	
3CE	53.5	52	71.5	69	77	4	5.5	1.5	1.5	19.5	0.38	1.57	0.86	0.542	
3DB	53.5	54	76.5	74	80	3	4.5	1.5	1.5	18	0.40	1.48	0.81	0.495	
3DC	53.5	53	76.5	73	81	3	5.5	1.5	1.5	20	0.40	1.48	0.81	0.607	
3DE	53.5	52	76.5	72	81	5	7	1.5	1.5	22	0.39	1.56	0.86	0.783	
2FB	55	59	91.5	86	93	3	5	2	1.5	21	0.35	1.74	0.96	1.01	
7FB	55	56	91.5	79	96	3	9	2	1.5	32.5	0.83	0.73	0.40	0.958	
2FD	55	56	91.5	82	93	3	8	2	1.5	25.5	0.35	1.74	0.96	1.46	
2BC	54.5	55	67.5	63.5	69	3	3	0.6	0.6	13.5	0.34	1.76	0.97	0.191	
	54.5	55	67.5	63.5	69.5	3	3	0.6	0.6	14.5	0.36	1.67	0.92	0.192	
3CC	55.5	56	74.5	72	77	4	4.5	1	1	17.5	0.42	1.42	0.78	0.366	
2CE	55.5	56	74.5	72	76	4	5	1	1	17.5	0.32	1.90	1.04	0.433	
3CE	58.5	56	76.5	74	82	4	6	1.5	1.5	20.5	0.41	1.46	0.80	0.58	
3DB	58.5	58	81.5	79	85	3	4.5	1.5	1.5	19.5	0.42	1.43	0.79	0.563	
3DC	58.5	58	81.5	78	85	3	5.5	1.5	1.5	21	0.42	1.43	0.79	0.648	
3DE	58.5	57	81.5	77	87	5	7.5	1.5	1.5	23.5	0.41	1.45	0.80	0.852	
2ED	62	59	88	84	94	6	6	2	2	25.5	0.34	1.75	0.96	1.31	
7FC	64	60	91	78	100	4	10	2.5	2.5	36.5	0.87	0.69	0.38	1.23	
2FB	62	65	100	95	102	3	6	2	2	23	0.35	1.74	0.96	1.31	
7FB	62	62	100	87	105	3	10	2	2	35	0.83	0.73	0.40	1.25	
2FD	62	62	100	90	102	3	9	2	2	28.5	0.35	1.74	0.96	1.92	
2BC	60.5	60.5	74.5	70.5	76.5	3	3	1	1	14.5	0.31	1.94	1.07	0.274	
3CC	63.5	63	81.5	81	86	4	5.5	1.5	1.5	20	0.41	1.48	0.81	0.563	
2CE	63.5	63	81.5	81	86	5	6	1.5	1.5	19.5	0.31	1.92	1.06	0.643	
3CE	63.5	62	86.5	83	91	5	7	1.5	1.5	22	0.37	1.60	0.88	0.846	
3DB	65	64	91.5	88	94	4	4.5	2	1.5	21	0.40	1.48	0.81	0.74	
3DC	65	63	91.5	87	95	4	5.5	2	1.5	22.5	0.40	1.48	0.81	0.876	
3DE	65	62	91.5	85	96	6	8	2	1.5	25.5	0.40	1.50	0.83	1.15	
2FB	67	71	110	104	111	4	6.5	2	2	24.5	0.35	1.74	0.96	1.66	
7FB	67	68	110	94	113	4	10.5	2	2	38	0.83	0.73	0.40	1.59	
2FD	67	68	110	99	111	4	10.5	2	2	30.5	0.35	1.74	0.96	2.44	
	65.5	65.5	79.5	76.5	82	3	3	1	1	15.5	0.33	1.80	0.99	0.296	
4CC	68.5	67	86.5	85	91	4	5.5	1.5	1.5	21	0.43	1.39	0.77	0.576	
2CE	68.5	67	86.5	85	90	5	6	1.5	1.5	20.5	0.33	1.83	1.01	0.684	
3CE	68.5	67	91.5	88	96	5	7	1.5	1.5	23.5	0.40	1.51	0.83	0.912	

Note: When selecting bearings with bearing numbers marked with " * ", please consult NTN Engineering.

Metric series

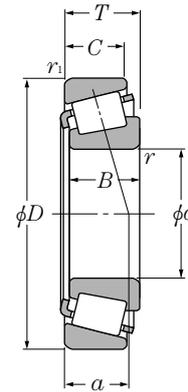

d 60 ~ 75mm

d	Boundary dimensions						Basic load ratings				Limiting speeds		Bearing numbers
	D	T	mm			dynamic	static	dynamic	static	min ⁻¹			
			B	C	r _{s min} ¹⁾	r _{1s min} ¹⁾	C _r	C _{or}	C _r	C _{or}	grease	oil	
60	110	23.75	22	19	2	1.5	105	125	10 700	12 700	3 400	4 500	4T-30212
	110	29.75	28	24	2	1.5	130	164	13 200	16 800	3 400	4 500	32212U
	110	38	38	29	2	1.5	161	223	16 400	22 700	3 400	4 500	33212U
	115	40	39	33	2.5	2.5	188	249	19 200	25 400	3 200	4 300	4T-T2EE060
	125	37	33.5	26	3	3	145	186	14 800	18 900	2 800	3 700	4T-T7FC060
	130	33.5	31	26	3	2.5	180	210	18 300	21 400	3 000	4 000	30312U
	130	33.5	31	22	3	2.5	150	176	15 300	17 900	2 700	3 600	4T-30312D
130	48.5	46	37	3	2.5	244	315	24 900	32 000	3 000	4 000	32312U	
65	90	17	17	14	1	1	48.5	85.0	4 900	8 700	3 700	4 900	32913XU
	100	23	23	17.5	1.5	1.5	83.0	128	8 450	13 000	3 400	4 600	4T-32013X
	100	27	27	21	1.5	1.5	97.5	156	9 950	16 000	3 400	4 600	4T-33013
	110	34	34	26.5	1.5	1.5	144	211	14 700	21 500	3 300	4 400	4T-33113
	120	24.75	23	20	2	1.5	123	148	12 500	15 000	3 100	4 200	4T-30213
	120	32.75	31	27	2	1.5	159	206	16 200	21 000	3 100	4 200	32213U
	120	41	41	32	2	1.5	195	265	19 900	27 100	3 100	4 200	33213U
	140	36	33	28	3	2.5	203	238	20 700	24 300	2 800	3 700	30313U
	140	36	33	23	3	2.5	173	204	17 700	20 900	2 500	3 300	4T-30313D
140	51	48	39	3	2.5	273	350	27 800	36 000	2 800	3 700	32313U	
70	100	20	20	16	1	1	68.5	110	7 000	11 200	3 400	4 600	32914XU
	110	25	25	19	1.5	1.5	105	160	10 700	16 400	3 200	4 200	4T-32014X
	110	31	31	25.5	1.5	1.5	127	204	12 900	20 800	3 200	4 200	4T-33014
	125	26.25	24	21	2	1.5	131	162	13 400	16 500	2 900	3 900	4T-30214
	125	33.25	31	27	2	1.5	166	220	16 900	22 400	2 900	3 900	32214U
	125	41	41	32	2	1.5	201	282	20 500	28 700	2 900	3 900	33214U
	140	39	35.5	27	3	3	173	231	17 600	23 500	2 400	3 200	4T-T7FC070
	150	38	35	30	3	2.5	230	272	23 400	27 800	2 600	3 500	30314U
	150	38	35	25	3	2.5	193	229	19 600	23 300	2 300	3 000	4T-30314D
150	54	51	42	3	2.5	310	405	31 500	41 000	2 600	3 500	32314U	
75	105	20	20	16	1	1	69.5	114	7 100	11 600	3 200	4 300	32915XU
	115	25	25	19	1.5	1.5	106	167	10 800	17 000	3 000	4 000	32015XU
	115	31	31	25.5	1.5	1.5	111	186	11 300	19 000	3 000	4 000	33015U
	130	27.25	25	22	2	1.5	139	175	14 200	17 900	2 700	3 600	4T-30215
	130	33.25	31	27	2	1.5	168	224	17 100	22 800	2 700	3 600	32215U
	130	41	41	31	2	1.5	208	298	21 200	30 500	2 700	3 600	33215U
	160	40	37	31	3	2.5	255	305	26 000	31 000	2 400	3 200	30315U
160	40	37	26	3	2.5	215	256	21 900	26 100	2 100	2 800	30315DU	

1) Minimal allowable dimension for chamfer dimension r or r₁.

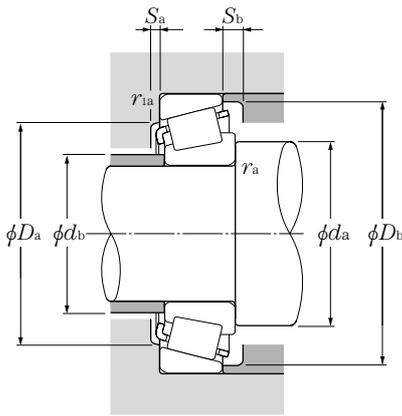

Equivalent radial load dynamic

$$P_r = X F_r + Y F_a$$

$\frac{F_a}{F_r} \leq e$		$\frac{F_a}{F_r} > e$	
X	Y	X	Y
1	0	0.4	Y_2

static

$$P_{or} = 0.5 F_r + Y_o F_a$$

When $P_{or} < F_r$ use $P_{or} = F_r$

For values of e , Y_2 and Y_o see the table below.

Dimensions series to ISO	Abutment and fillet dimensions									Load center mm	Constant e	Axial load factors		Mass kg (approx.)
	d_a min	d_b max	D_a max	D_b min	S_a min	S_b min	r_{as} max	r_{ias} max	a			e	Y_2	
3EB	70	70	101.5	96	103	4	4.5	2	1.5	22	0.40	1.48	0.81	0.949
3EC	70	69	101.5	95	104	4	5.5	2	1.5	25	0.40	1.48	0.81	1.18
3EE	70	69	101.5	93	105	6	9	2	1.5	27.5	0.40	1.48	0.82	1.55
2EE	72	70	103	98	109	6	7	2	2	28.5	0.33	1.80	0.99	1.86
7FC	74	72	111	94	119	4	11	2.5	2.5	42	0.82	0.73	0.40	2
2FB	74	77	118	112	120	4	7.5	2.5	2	26.5	0.35	1.74	0.96	2.06
7FB	74	73	118	103	124	4	11.5	2.5	2	40.5	0.83	0.73	0.40	1.97
2FD	74	74	118	107	120	4	11.5	2.5	2	32	0.35	1.74	0.96	3.02
2BC	70.5	70	84.5	80	86.5	4	5.5	1.5	1.5	16.5	0.35	1.70	0.93	0.315
4CC	73.5	72	91.5	90	97	4	5.5	1.5	1.5	22.5	0.46	1.31	0.72	0.63
2CE	73.5	72	91.5	89	96	5	6	1.5	1.5	21.5	0.35	1.72	0.95	0.732
3DE	73.5	73	101.5	96	106	6	7.5	1.5	1.5	26	0.39	1.55	0.85	1.28
3EB	75	77	111.5	106	113	4	4.5	2	1.5	23.5	0.40	1.48	0.81	1.18
3EC	75	75	111.5	104	115	4	5.5	2	1.5	27	0.40	1.48	0.81	1.58
3EE	75	74	111.5	102	115	7	9	2	1.5	29.5	0.39	1.54	0.85	1.98
2GB	79	83	128	122	130	4	8	2.5	2	28.5	0.35	1.74	0.96	2.55
7GB	79	79	128	111	133	4	13	2.5	2	44	0.83	0.73	0.40	2.42
2GD	79	80	128	117	130	4	12	2.5	2	34.5	0.35	1.74	0.96	3.66
2BC	75.5	75	94.5	90	96	4	4	1	1	18	0.32	1.90	1.05	0.487
4CC	78.5	78	101.5	98	105	5	6	1.5	1.5	24	0.43	1.38	0.76	0.848
2CE	78.5	79	101.5	99	105	5	5.5	1.5	1.5	22.5	0.28	2.11	1.16	1.07
3EB	80	81	116.5	110	118	4	5	2	1.5	25.5	0.42	1.43	0.79	1.26
3EC	80	80	116.5	108	119	4	6	2	1.5	28.5	0.42	1.43	0.79	1.68
3EE	80	79	116.5	107	120	7	9	2	1.5	31	0.41	1.47	0.81	2.1
7FC	84	82	126	106	135	5	12	2.5	2.5	47.5	0.87	0.69	0.38	2.61
2GB	84	89	138	130	140	4	8	2.5	2	30	0.35	1.74	0.96	3.06
7GB	84	84	138	118	142	4	13	2.5	2	47	0.83	0.73	0.40	2.92
2GD	84	86	138	125	140	4	12	2.5	2	36.5	0.35	1.74	0.96	4.46
2BC	80.5	80	99.5	94	101.5	4	4	1	1	19	0.33	1.80	0.99	0.511
4CC	83.5	83	106.5	103	110	5	6	1.5	1.5	25.5	0.46	1.31	0.72	0.909
2CE	83.5	85	106.5	101	110.5	6	5.5	1.5	1.5	23	0.30	2.01	1.11	1.11
4DB	85	85	121.5	115	124	4	5	2	1.5	27	0.44	1.38	0.76	1.41
4DC	85	85	121.5	114	125	4	6	2	1.5	30	0.44	1.38	0.76	1.74
3EE	85	83	121.5	111	125	7	10	2	1.5	32	0.43	1.40	0.77	2.2
2GB	89	95	148	139	149	4	9	2.5	2	32	0.35	1.74	0.96	3.57
7GB	89	91	148	127	151	6	14	2.5	2	50	0.83	0.73	0.40	3.47

Metric series

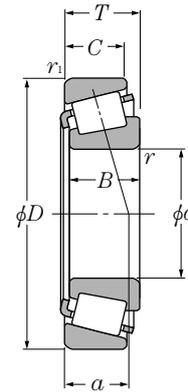

d 75 ~ 95mm

d	Boundary dimensions						Basic load ratings				Limiting speeds		Bearing numbers
	D	T	mm		$r_s \text{ min}^{1)}$	$r_{1s} \text{ min}^{1)}$	dynamic	static	dynamic	static	grease	oil	
			B	C			kN	C_{or}	kgf	C_{or}			
75	160	58	55	45	3	2.5	355	470	36 000	47 500	2 400	3 200	32315U
80	110	20	20	16	1	1	72.0	121	7 350	12 400	3 000	4 000	32916XU
	125	29	29	22	1.5	1.5	139	216	14 200	22 000	2 800	3 700	32016XU
	125	36	36	29.5	1.5	1.5	173	284	17 600	29 000	2 800	3 700	33016U
	140	28.25	26	22	2.5	2	160	200	16 300	20 400	2 500	3 400	30216U
	140	35.25	33	28	2.5	2	199	265	20 300	27 000	2 500	3 400	32216U
	140	46	46	35	2.5	2	250	365	25 500	37 500	2 500	3 400	33216U
	170	42.5	39	33	3	2.5	291	350	29 700	36 000	2 300	3 000	30316U
170	42.5	39	27	3	2.5	236	283	24 100	28 900	2 000	2 700	30316DU	
170	61.5	58	48	3	2.5	395	525	40 500	53 500	2 300	3 000	32316U	
85	120	23	23	18	1.5	1.5	94.0	157	9 600	16 100	2 800	3 800	32917XU
	130	29	29	22	1.5	1.5	142	224	14 400	22 900	2 600	3 500	32017XU
	130	36	36	29.5	1.5	1.5	176	296	18 000	30 000	2 600	3 500	33017U
	150	30.5	28	24	2.5	2	183	232	18 600	23 600	2 400	3 200	30217U
	150	38.5	36	30	2.5	2	224	300	22 900	30 500	2 400	3 200	32217U
	150	49	49	37	2.5	2	284	420	29 000	43 000	2 400	3 200	33217U
	180	44.5	41	34	4	3	305	365	31 000	37 000	2 100	2 900	30317U
	180	44.5	41	28	4	3	247	293	25 200	29 900	1 900	2 500	30317DU
180	63.5	60	49	4	3	405	525	41 000	53 500	2 100	2 900	32317U	
90	125	23	23	18	1.5	1.5	97.5	168	9 950	17 100	2 700	3 600	32918XU
	140	32	32	24	2	1.5	168	270	17 200	27 600	2 500	3 300	32018XU
	140	39	39	32.5	2	1.5	215	360	21 900	36 500	2 500	3 300	33018U
	160	32.5	30	26	2.5	2	208	267	21 200	27 200	2 200	3 000	30218U
	160	42.5	40	34	2.5	2	262	360	26 700	36 500	2 200	3 000	32218U
	190	46.5	43	36	4	3	335	405	34 500	41 500	2 000	2 700	30318U
	190	46.5	43	30	4	3	270	320	27 600	33 000	1 800	2 400	30318DU
190	67.5	64	53	4	3	450	595	46 000	60 500	2 000	2 700	32318U	
95	130	23	23	18	1.5	1.5	101	178	10 300	18 200	2 500	3 400	32919XU
	145	32	32	24	2	1.5	171	280	17 500	28 600	2 300	3 100	32019XU
	145	39	39	32.5	2	1.5	219	375	22 400	38 000	2 300	3 100	33019U
	170	34.5	32	27	3	2.5	226	290	23 000	29 600	2 100	2 800	30219U
	170	45.5	43	37	3	2.5	299	415	30 500	42 500	2 100	2 800	32219U
	200	49.5	45	38	4	3	365	445	37 500	45 500	1 900	2 500	30319U
	200	49.5	45	38	3	3	315	365	32 500	37 500	1 900	2 500	30319²⁾
200	49.5	45	32	4	3	296	355	30 000	36 500	1 700	2 200	30319DU	

1) Minimal allowable dimension for chamfer dimension r or r_1 .
 2) This bearing does not incorporate the subunit dimensions.

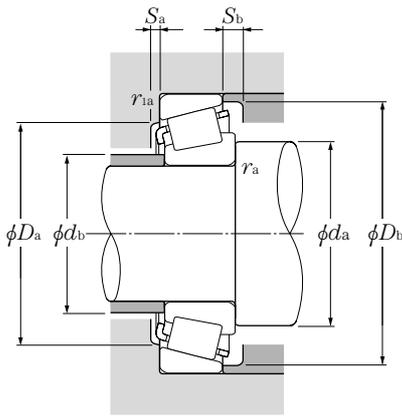

Equivalent radial load dynamic

$$P_r = X F_r + Y F_a$$

$\frac{F_a}{F_r} \leq e$		$\frac{F_a}{F_r} > e$	
X	Y	X	Y
1	0	0.4	Y ₂

static

$$P_{or} = 0.5 F_r + Y_0 F_a$$

When $P_{or} < F_r$ use $P_{or} = F_r$

For values of e , Y_2 and Y_0 see the table below.

Dimensions series to ISO	Abutment and fillet dimensions									Load center mm	Constant e	Axial load factors		Mass kg (approx.)
	d_a min	d_b max	D_a max	D_b min	S_a min	S_b min	r_{as} max	r_{ias} max	Y_2			Y_0		
2GD	89	91	148	133	149	4	13	2.5	2	39	0.35	1.74	0.96	5.35
2BC	85.5	85	104.5	99	106.5	4	4	1	1	20	0.35	1.71	0.94	0.54
3CC	88.5	89	116.5	112	120	6	7	1.5	1.5	27	0.42	1.42	0.78	1.28
2CE	88.5	89	116.5	112	119	6	6.5	1.5	1.5	25	0.28	2.16	1.19	1.6
3EB	92	91	130	124	132	4	6	2	2	27.5	0.42	1.43	0.79	1.72
3EC	92	90	130	122	134	4	7	2	2	31	0.42	1.43	0.79	2.18
3EE	92	89	130	119	135	7	11	2	2	35	0.43	1.41	0.78	2.92
2GB	94	102	158	148	159	4	9.5	2.5	2	34	0.35	1.74	0.96	4.41
7GB	94	97	158	134	159	4	15.5	2.5	2	53.5	0.83	0.73	0.40	4.11
2GD	94	98	158	142	159	4	13.5	2.5	2	41.5	0.35	1.74	0.96	6.41
2BC	93.5	92	111.5	111	115	4	5	1.5	1.5	21	0.33	1.83	1.01	0.773
4CC	93.5	94	121.5	117	125	6	7	1.5	1.5	28.5	0.44	1.36	0.75	1.35
2CE	93.5	94	121.5	118	125	6	6.5	1.5	1.5	26	0.29	2.06	1.13	1.7
3EB	97	97	140	132	141	5	6.5	2	2	30	0.42	1.43	0.79	2.14
3EC	97	96	140	130	142	5	8.5	2	2	33.5	0.42	1.43	0.79	2.75
3EE	97	95	140	128	144	7	12	2	2	37.5	0.42	1.43	0.79	3.58
2GB	103	107	166	156	167	5	10.5	3	2.5	35.5	0.35	1.74	0.96	5.2
7GB	103	103	166	143	169	6	16.5	3	2.5	56	0.83	0.73	0.40	4.85
2GD	103	102	166	150	167	5	14.5	3	2.5	43	0.35	1.74	0.96	7.15
2BC	98.5	96	116.5	112.5	120.5	4	5	1.5	1.5	22	0.34	1.75	0.96	0.817
3CC	100	100	131.5	125	134	6	8	2	1.5	30	0.42	1.42	0.78	1.79
2CE	100	100	131.5	127	135	7	6.5	2	1.5	28	0.27	2.23	1.23	2.18
3FB	102	103	150	140	150	5	6.5	2	2	32	0.42	1.43	0.79	2.66
3FC	102	102	150	138	152	5	8.5	2	2	36	0.42	1.43	0.79	3.49
2GB	108	113	176	165	177	5	10.5	3	2.5	37.5	0.35	1.74	0.96	6.03
7GB	108	109	176	151	179	6	16.5	3	2.5	59	0.83	0.73	0.40	5.66
2GD	108	108	176	157	177	5	14.5	3	2.5	45.5	0.35	1.74	0.96	8.57
2BC	103.5	101	121.5	117	125.5	4	5	1.5	1.5	23.5	0.36	1.68	0.92	0.851
4CC	105	105	136.5	130	140	6	8	2	1.5	31.5	0.44	1.36	0.75	1.83
2CE	105	104	136.5	131	139	7	6.5	2	1.5	28.5	0.28	2.16	1.19	2.27
3FB	109	110	158	149	159	5	7.5	2.5	2	34	0.42	1.43	0.79	3.07
3FC	109	108	158	145	161	5	8.5	2.5	2	39	0.42	1.43	0.79	4.3
2GB	113	118	186	172	186	5	11.5	3	2.5	40	0.35	1.74	0.96	6.98
	113	118	186	172	186	5	11.5	3	2.5	40	0.35	1.73	0.95	6.58
7GB	113	114	186	154	187	6	17.5	3	2.5	62.5	0.83	0.73	0.40	6.47

Note: When selecting bearings with bearing numbers marked with " * ", please consult NTN Engineering.

Metric series

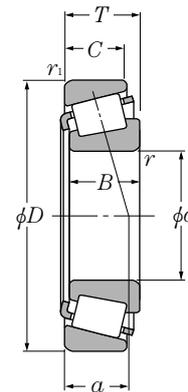

d 95 ~ 120mm

d	Boundary dimensions						Basic load ratings				Limiting speeds		Bearing numbers
	D	T	mm		$r_{s \min}^{1)}$	$r_{1s \min}^{1)}$	dynamic	static	dynamic	static	grease	oil	
			B	C			kN	C_{or}	kgf	C_{or}			
95	200	71.5	67	55	4	3	505	670	51 500	68 500	1 900	2 500	32319U
100	140	25	25	20	1.5	1.5	121	206	12 300	21 000	2 400	3 200	* 32920XU
	140	25	24	20	1.5	1.5	97.5	162	9 950	16 500	2 400	3 200	32920 ²⁾
	145	24	22.5	17.5	3	3	107	153	10 900	15 600	1 800	2 400	4T-T4CB100
	150	32	32	24	2	1.5	170	281	17 300	28 600	2 200	3 000	32020XU
	150	39	39	32.5	2	1.5	224	390	22 800	39 500	2 200	3 000	33020U
	180	37	34	29	3	2.5	258	335	26 300	34 500	2 000	2 700	30220U
	180	49	46	39	3	2.5	330	465	33 500	47 500	2 000	2 700	32220U
	215	51.5	47	39	4	3	410	500	41 500	51 000	1 800	2 400	30320U
	215	51.5	47	39	3	3	345	400	35 000	40 500	1 800	2 400	30320 ²⁾
	215	56.5	51	35	4	3	355	435	36 000	44 000	1 800	2 400	31320XU
215	77.5	73	60	4	3	570	770	58 500	78 500	1 800	2 400	32320U	
105	145	25	25	20	1.5	1.5	126	219	12 800	22 400	2 300	3 000	32921XA ²⁾
	160	35	35	26	2.5	2	201	335	20 500	34 000	2 100	2 800	32021XU
	160	43	43	34	2.5	2	245	420	25 000	43 000	2 100	2 800	33021U
	190	39	36	30	3	2.5	287	380	29 300	38 500	1 900	2 500	30221U
	190	53	50	43	3	2.5	380	540	38 500	55 500	1 900	2 500	32221U
	225	53.5	49	41	4	3	435	530	44 500	54 500	1 700	2 300	* 30321U
	225	53.5	49	41	3	3	365	420	37 000	43 000	1 700	2 300	30321 ²⁾
	225	58	53	36	4	3	380	470	39 000	47 500	1 700	2 300	* 31321XU
225	81.5	77	63	4	3	610	825	62 500	84 500	1 700	2 300	32321U	
110	150	25	25	20	1.5	1.5	127	226	13 000	23 100	2 200	2 900	32922XA ²⁾
	170	38	38	29	2.5	2	236	390	24 000	39 500	2 000	2 700	32022XU
	170	47	47	37	2.5	2	288	500	29 400	51 000	2 000	2 700	33022U
	200	41	38	32	3	2.5	325	435	33 000	44 000	1 800	2 400	30222U
	200	56	53	46	3	2.5	420	605	43 000	62 000	1 800	2 400	32222U
	240	54.5	50	42	4	3	480	590	49 000	60 000	1 600	2 200	* 30322U
	240	54.5	50	42	3	3	400	465	40 500	47 000	1 600	2 200	30322 ²⁾
	240	63	57	38	4	3	430	535	44 000	54 500	1 600	2 200	31322XU
	240	84.5	80	65	4	3	705	970	72 000	98 500	1 600	2 200	* 32322U
	240	84.5	80	65	3	3	620	830	63 500	84 500	1 600	2 200	32322 ²⁾
120	165	29	29	23	1.5	1.5	162	294	16 500	30 000	2 000	2 600	* 32924XU
	165	29	27	23	1.5	1.5	118	205	12 000	20 900	2 000	2 600	32924 ²⁾
	180	38	38	29	2.5	2	245	420	25 000	43 000	1 800	2 500	32024XU
	215	43.5	40	34	3	2.5	345	470	35 500	48 000	1 700	2 200	30224U

1) Minimal allowable dimension for chamfer dimension r or r_1 .
 2) This bearing does not incorporate the subunit dimensions.

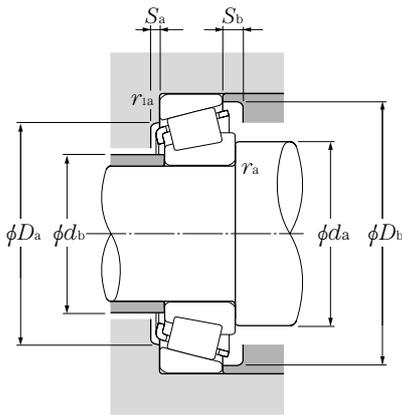

Equivalent radial load dynamic

$$P_r = X F_r + Y F_a$$

$\frac{F_a}{F_r} \leq e$		$\frac{F_a}{F_r} > e$	
X	Y	X	Y
1	0	0.4	Y ₂

static

$$P_{or} = 0.5 F_r + Y_0 F_a$$

When $P_{or} < F_r$ use $P_{or} = F_r$

For values of e , Y_2 and Y_0 see the table below.

Dimensions series to ISO	Abutment and fillet dimensions										Load center mm	Constant e	Axial load factors		Mass kg (approx.)
	d_a min	d_b max	D_a max	D_b min	S_a min	S_b min	r_{as} max	r_{ias} max	Y_2	Y_0					
2GD	113	113	186	166	186	5	16.5	3	2.5	49	0.35	1.74	0.96	10.1	
2CC	108.5	107.5	131.5	127.5	135.5	4	5	1.5	1.5	24.5	0.33	1.82	1.00	1.14	
4CB	114	109	131	130	140	4	6.5	2.5	2.5	30	0.47	1.27	0.70	1.15	
4CC	110	109	141.5	134	144	6	8	2	1.5	32.5	0.46	1.31	0.72	1.91	
2CE	110	108	141.5	135	143	7	6.5	2	1.5	29.5	0.29	2.09	1.15	2.37	
3FB	114	116	168	157	168	5	8	2.5	2	36	0.42	1.43	0.79	3.78	
3FC	114	114	168	154	171	5	10	2.5	2	41.5	0.42	1.43	0.79	5.12	
2GB	118	127	201	184	200	5	12.5	3	2.5	41.5	0.35	1.74	0.96	8.56	
	118	127	201	184	200	5	12.5	3	2.5	42	0.35	1.73	0.95	7.72	
7GB	118	121	201	168	202	7	21.5	3	2.5	69	0.83	0.73	0.40	8.67	
2GD	118	121	201	177	200	5	17.5	3	2.5	53	0.35	1.74	0.96	12.7	
	113.5	113.5	136.5	131.5	140.5	5	5	1.5	1.5	25	0.34	1.76	0.97	1.20	
4DC	117	116	150	143	154	6	9	2	2	34.5	0.44	1.35	0.74	2.42	
2DE	117	116	150	145	153	7	9	2	2	31	0.28	2.12	1.17	3.00	
3FB	119	122	178	165	178	6	9	2.5	2	38	0.42	1.43	0.79	4.39	
3FC	119	119	178	161	180	6	10	2.5	2	44	0.42	1.43	0.79	6.25	
2GB	123	132	211	193	209	6	12.5	3	2.5	43.5	0.35	1.74	0.96	9.79	
	123	132	211	193	209	6	12.5	3	2.5	43.5	0.35	1.73	0.95	8.93	
7GB	123	126	211	176	211	7	22	3	2.5	71.5	0.83	0.73	0.40	9.68	
2GD	123	128	211	185	209	6	18.5	3	2.5	55	0.35	1.74	0.96	14.5	
	118.5	117.5	141.5	137	145.5	5	5	1.5	1.5	26.5	0.36	1.69	0.93	1.23	
4DC	122	122	160	152	163	7	9	2	2	36.5	0.43	1.39	0.77	3.07	
2DE	122	121	160	152	161	7	10	2	2	33.5	0.29	2.09	1.15	3.80	
3FB	124	129	188	174	188	6	9	2.5	2	40	0.42	1.43	0.79	5.18	
3FC	124	126	188	170	190	6	10	2.5	2	47	0.42	1.43	0.79	7.43	
2GB	128	141	226	206	222	6	12.5	3	2.5	45.5	0.35	1.74	0.96	11.4	
	128	141	226	206	222	6	12.5	3	2.5	44	0.35	1.73	0.95	10.5	
7GB	128	135	226	188	224	7	25	3	2.5	76	0.83	0.73	0.40	11.9	
2GD	128	135	226	198	222	6	19.5	3	2.5	57.5	0.35	1.74	0.96	18.0	
	128	135	226	198	222	6.5	19.5	3	2.5	56	0.35	1.73	0.95	16.9	
2CC	128.5	128.5	156.5	150	160	6	6	1.5	1.5	29.5	0.35	1.72	0.95	1.77	
	128.5	130.5	156.5	147.5	159.5	6	6	1.5	1.5	31	0.37	1.60	0.88	1.63	
4DC	132	131	170	161	173	7	9	2	2	39	0.46	1.31	0.72	3.25	
4FB	134	140	203	187	203	6	9.5	2.5	2	44	0.44	1.38	0.76	6.23	

Note: When selecting bearings with bearing numbers marked with " * ", please consult NTN Engineering.

Metric series

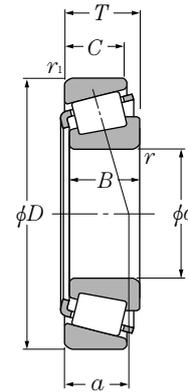

d 120 ~ 170mm

d	Boundary dimensions						Basic load ratings				Limiting speeds		Bearing numbers
	D	T	mm			dynamic	static	dynamic	static	min ⁻¹			
			B	C	r _s min ¹⁾	r _{1s} min ¹⁾	C _r	C _{or}	C _r	C _{or}	grease	oil	
120	215	61.5	58	50	3	2.5	460	680	47 000	69 500	1 700	2 200	32224U
	260	59.5	55	46	4	3	560	695	57 000	71 000	1 500	2 000	30324U
	260	59.5	55	46	3	3	465	550	47 500	56 000	1 500	2 000	30324 ²⁾
	260	68	62	42	4	3	515	655	52 500	67 000	1 500	2 000	31324XU
	260	90.5	86	69	4	3	815	1 130	83 000	116 000	1 500	2 000	32324U
130	180	32	32	25	2	1.5	194	350	19 800	36 000	1 800	2 400	* 32926XU
	180	32	30	26	2	2	142	252	14 500	25 700	1 800	2 400	32926 ²⁾
	200	45	45	34	2.5	2	320	545	32 500	55 500	1 700	2 200	32026XU
	230	43.75	40	34	4	3	375	505	38 000	51 500	1 500	2 000	30226U
	230	67.75	64	54	4	3	530	815	54 000	83 000	1 500	2 000	32226U
	280	63.75	58	49	5	4	650	830	66 000	84 500	1 400	1 800	30326U
280	72	66	44	5	4	600	780	61 500	79 500	1 400	1 800	31326XU	
140	190	32	32	25	2	1.5	200	375	20 400	38 000	1 700	2 200	32928XU
	210	45	45	34	2.5	2	330	580	33 500	59 500	1 600	2 100	32028XU
	250	45.75	42	36	4	3	420	570	43 000	58 500	1 400	1 900	* 30228U
	250	45.75	42	36	3	3	375	485	38 000	49 500	1 400	1 900	30228 ²⁾
	250	71.75	68	58	4	3	610	920	62 500	94 000	1 400	1 900	32228U
	300	67.75	62	53	5	4	735	950	75 000	97 000	1 300	1 700	30328U
300	77	70	47	5	4	685	905	70 000	92 500	1 300	1 700	31328XU	
150	210	38	38	30	2.5	2	268	490	27 300	50 000	1 600	2 100	32930XU
	225	48	48	36	3	2.5	370	655	37 500	67 000	1 400	1 900	32030XU
	270	49	45	38	4	3	450	605	46 000	61 500	1 300	1 700	30230U
	270	77	73	60	4	3	700	1070	71 500	109 000	1 300	1 700	32230U
	320	72	65	55	5	4	825	1070	84 000	109 000	1 200	1 600	* 30330U
	320	72	65	55	4	4	680	875	69 500	89 000	1 200	1 600	30330 ²⁾
320	82	75	50	5	4	775	1 030	79 000	105 000	1 200	1 600	31330XU	
160	220	38	38	30	2.5	2	276	520	28 200	53 000	1 500	1 900	32932XU
	240	51	51	38	3	2.5	435	790	44 500	80 500	1 400	1 800	32032XU
	290	52	48	40	4	3	525	720	53 500	73 500	1 200	1 600	30232U
	290	84	80	67	4	3	890	1 420	90 500	145 000	1 200	1 600	32232U
	340	75	68	58	5	4	915	1 200	93 500	122 000	1 100	1 500	* 30332U
340	75	68	58	4	4	755	975	77 000	99 500	1 100	1 500	30332 ²⁾	
170	230	38	38	30	2.5	2	286	560	29 200	57 000	1 400	1 800	32934XU

1) Minimal allowable dimension for chamfer dimension r or r_1 .
 2) This bearing does not incorporate the subunit dimensions.

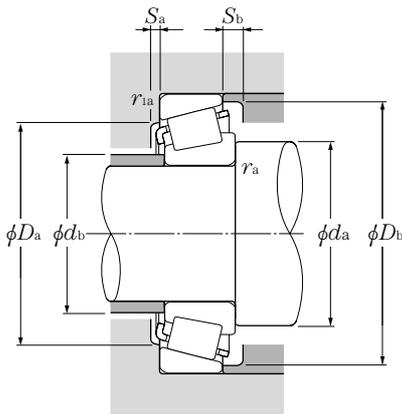

Equivalent radial load dynamic

$$P_r = X F_r + Y F_a$$

$\frac{F_a}{F_r} \leq e$		$\frac{F_a}{F_r} > e$	
X	Y	X	Y
1	0	0.4	Y ₂

static

$$P_{or} = 0.5 F_r + Y_o F_a$$

When $P_{or} < F_r$ use $P_{or} = F_r$

For values of e , Y_2 and Y_o see the table below.

Dimensions series to ISO	Abutment and fillet dimensions										Load center mm	Constant e	Axial load factors		Mass kg (approx.)
	d_a min	d_b max	D_a max	D_b min	S_a min	S_b min	r_{as} max	r_{1as} max	Y_2	Y_o					
4FD	134	136	203	181	204	6	11.5	2.5	2	51.5	0.44	1.38	0.76	9.08	
2GB	138	152	246	221	239	6	13.5	3	2.5	49	0.35	1.74	0.96	14.2	
	138	152	246	221	239	6	13.5	3	2.5	48.5	0.35	1.73	0.95	13.2	
7GB	138	145	246	203	244	9	26	3	2.5	82.5	0.83	0.73	0.40	15.4	
2GD	138	145	246	213	239	6	21.5	3	2.5	61.5	0.35	1.74	0.96	22.4	
2CC	140	139	171.5	163.5	174	6	7	2	1.5	31.5	0.34	1.77	0.97	2.36	
	140	139	170	163.5	174	6	6	2	2	34	0.37	1.60	0.88	2.22	
4EC	142	144	190	178	192	8	11	2	2	43.5	0.43	1.38	0.76	4.96	
4FB	148	152	216	203	218	7	9.5	3	2.5	45.5	0.44	1.38	0.76	7.25	
4FD	148	146	216	193	219	7	13.5	3	2.5	57	0.44	1.38	0.76	11.2	
2GB	152	164	262	239	255	8	14.5	4	3	53.5	0.35	1.74	0.96	17.4	
7GB	152	155.5	262	214.5	263	9	28	4	3	87.5	0.83	0.73	0.40	19	
2CC	150	150	181.5	177	184	6	6	2	1.5	34	0.36	1.67	0.92	2.51	
4DC	152	153	200	187	202	8	11	2	2	46	0.46	1.31	0.72	5.28	
4FB	158	163	236	219	237	7	9.5	3	2.5	48.5	0.44	1.38	0.76	9.26	
	158	163	236	219	237	7	9.5	2.5	2.5	47.5	0.43	1.39	0.77	8.37	
4FD	158	158	236	210	238	9	13.5	3	2.5	61	0.44	1.38	0.76	14.1	
2GB	162	175.5	282	252	275.5	9	14.5	4	3	56.5	0.35	1.74	0.96	21.2	
7GB	162	165	282	234	280	9	30	4	3	94	0.83	0.73	0.40	23	
2DC	162	162	200	192	202	7	8	2	2	36.5	0.33	1.83	1.01	3.92	
4EC	164	164	213	200	216	8	12	2.5	2	49.5	0.46	1.31	0.72	6.37	
4GB	168	175	256	234	255	7	11	3	2.5	51.5	0.44	1.38	0.76	11.2	
4GD	168	170	256	226	254	8	17	3	2.5	64.5	0.44	1.38	0.76	18.2	
2GB	172	193	302	269	292	8	17	4	3	61	0.35	1.74	0.96	25.5	
	172	193	302	269	292	8	17	4	3	62.5	0.37	1.60	0.88	24.7	
7GB	172	176	302	250	302	9	32	4	3	100.5	0.83	0.73	0.40	27.7	
2DC	172	170.5	210	199	213.5	7	8	2	2	38.5	0.35	1.73	0.95	4.15	
4EC	174	175	228	213	231	8	13	2.5	2	52.5	0.46	1.31	0.72	7.8	
4GB	178	189	276	252	272	8	12	3	2.5	55.5	0.44	1.38	0.76	12.9	
4GD	178	182	276	242	275	10	17	3	2.5	70	0.44	1.38	0.76	23.5	
2GB	182	205	322	286	310	10	17	4	3	64	0.35	1.74	0.96	29.9	
	182	205	322	286	311	10	17	4	3	65.5	0.37	1.60	0.88	29.2	
3DC	182	183	220	213	222	7	8	2	2	42.5	0.38	1.57	0.86	4.4	

Note: When selecting bearings with bearing numbers marked with " * ", please consult NTN Engineering.

Metric series

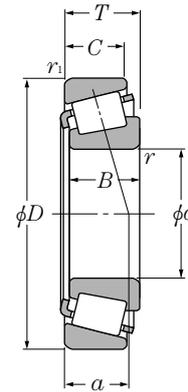

d 170 ~ 300mm

d	Boundary dimensions						Basic load ratings				Limiting speeds		Bearing numbers
	D	T	mm		$r_s \text{ min}^{1)}$	$r_{1s} \text{ min}^{1)}$	dynamic	static	dynamic	static	min ⁻¹		
			B	C			kN	C_{or}	kgf	C_{or}	grease	oil	
170	260	57	57	43	3	2.5	500	895	51 000	91 000	1 300	1 700	32034XU
	310	57	52	43	5	4	610	845	62 000	86 500	1 100	1 500	30234U
	310	91	86	71	5	4	1 000	1 600	102 000	163 000	1 100	1 500	32234U
	360	80	72	62	5	4	1 010	1 320	103 000	135 000	1 000	1 400	* 30334U
	360	80	72	62	4	4	845	1 100	86 000	113 000	1 000	1 400	30334 ²⁾
180	250	45	45	34	2.5	2	350	700	36 000	71 500	1 300	1 700	32936XU
	280	64	64	48	3	2.5	645	1 170	66 000	119 000	1 200	1 600	32036XUE1
	320	57	52	43	5	4	630	890	64 000	91 000	1 100	1 400	30236U
	320	91	86	71	5	4	1 030	1 690	105 000	172 000	1 100	1 400	32236U
190	260	45	45	34	2.5	2	355	710	36 000	72 000	1 200	1 600	* 32938XU
	260	45	42	36	2.5	2.5	280	525	28 600	53 500	1 200	1 600	32938 ²⁾
	290	64	64	48	3	2.5	655	1 210	67 000	124 000	1 100	1 500	32038XUE1
	340	60	55	46	5	4	715	1 000	73 000	102 000	1 000	1 300	30238U
	340	97	92	75	5	4	1 150	1 850	117 000	189 000	1 000	1 300	* 32238U
	340	97	92	75	4	4	1 000	1 670	102 000	171 000	1 000	1 300	32238 ²⁾
200	280	51	51	39	3	2.5	485	895	49 000	91 000	1 100	1 500	32940XUE1
	310	70	70	53	3	2.5	800	1 470	81 500	149 000	1 100	1 400	32040XUE1
	360	64	58	48	5	4	785	1 110	80 000	113 000	950	1 300	30240U
	360	104	98	82	5	4	1 320	2 130	134 000	217 000	950	1 300	32240U
220	300	51	51	39	3	2.5	480	950	49 000	97 000	1 000	1 400	* 32944XUE1
	300	51	48	41	2.5	2.5	345	670	35 500	68 500	1 000	1 400	32944E1 ²⁾
	340	76	76	57	4	3	920	1 690	94 000	173 000	960	1 300	32044XU
240	320	51	51	39	3	2.5	490	1 000	50 000	102 000	940	1 200	32948XUE1
	360	76	76	57	4	3	930	1 760	95 000	179 000	870	1 200	32048XU
260	360	63.5	63.5	48	3	2.5	705	1 430	72 000	146 000	860	1 100	32952XUE1
	400	87	87	65	5	4	1 200	2 270	123 000	231 000	800	1 100	32052XU
280	380	63.5	63.5	48	3	2.5	725	1 520	74 000	155 000	790	1 100	32956XUE1
	420	87	87	65	5	4	1 220	2 350	125 000	240 000	740	980	32056XU
300	420	76	76	57	4	3	1 010	2 090	103 000	213 000	720	970	32960XUE1
	460	100	100	74	5	4	1 490	2 830	152 000	289 000	680	910	32060XU

1) Minimal allowable dimension for chamfer dimension r or r_1 .
 2) This bearing does not incorporate the subunit dimensions.

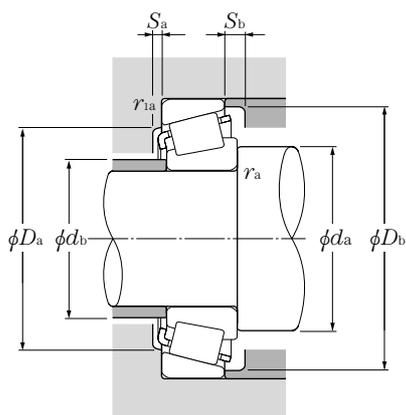

Equivalent radial load dynamic

$$P_r = XF_r + YF_a$$

$\frac{F_a}{F_r} \leq e$		$\frac{F_a}{F_r} > e$	
X	Y	X	Y
1	0	0.4	Y ₂

static

$$P_{or} = 0.5F_r + Y_oF_a$$

When $P_{or} < F_r$ use $P_{or} = F_r$

For values of e , Y_2 and Y_o see the table below.

Dimensions series to ISO	Abutment and fillet dimensions									Load center mm	Constant e	Axial load factors		Mass kg (approx.)
	d_a min	d_b max	D_a max	D_b min	S_a min	S_b min	r_{as} max	r_{1as} max	Y_2			Y_o		
4EC	184	187	248	230	249	10	14	2.5	2	56	0.44	1.35	0.74	10.5
4GB	192	203	292	266	290.5	8	14	4	3	60.5	0.44	1.38	0.76	17
4GD	192	201	292	258	293	10	20	4	3	75	0.44	1.38	0.76	28.7
2GB	192	212.5	342	305	332.5	10	18	4	3	68	0.35	1.74	0.96	35.3
	192	215.5	342	297	327	10	18	4	3	69.5	0.37	1.60	0.88	34.8
4DC	192	193	240	225	241	8	11	2	2	54	0.48	1.25	0.69	6.54
3FD	194	199	268	247	267	10	16	2.5	2	59.5	0.42	1.42	0.78	14.5
4GB	202	211	302	274	297	9	14	4	3	63	0.45	1.33	0.73	17.7
4GD	202	204	302	267	305	10	20	4	3	77.5	0.45	1.33	0.73	30.7
4DC	202	204	250	235	251	8	11	2	2	55	0.48	1.26	0.69	6.77
	202	204	248	235	251	8	9	2	2	48.5	0.37	1.60	0.88	6.43
4FD	204	209	278	257	279	10	16	2.5	2	62.5	0.44	1.36	0.75	15.1
4GB	212	228	322	295	316	9	14	4	3	64	0.44	1.38	0.76	20.8
4GD	212	216	322	282	323	11	22	4	3	82	0.44	1.38	0.76	36.1
	212	216	322	286	323	11	22	4	3	87.5	0.49	1.23	0.68	33.3
3EC	214	214	268	254	271	9	12	2.5	2	53.5	0.39	1.52	0.84	8.88
4FD	214	221	298	273	297	11	17	2.5	2	66.5	0.43	1.39	0.77	19.3
4GB	222	242	342	311	336	10	16	4	3	70	0.44	1.38	0.76	25.4
3GD	222	224.5	342	299	342.5	11	22	4	3	85	0.41	1.48	0.81	43.4
3EC	234	234	288	271	290	10	12	2.5	2	59.5	0.43	1.41	0.78	10.2
	234	235	288	274	290	10	10	2.5	2	57	0.39	1.55	0.85	9.63
4FD	238	243	326	300	326	12	19	3	2.5	72.5	0.43	1.39	0.77	25
4EC	254	254	308	290	311	10	12	2.5	2	65.5	0.46	1.31	0.72	10.9
4FD	258	261	346	318	346	12	19	3	2.5	78	0.46	1.31	0.72	26.8
3EC	274	279	348	325	347	11	15	2.5	2	69.5	0.41	1.48	0.81	18.8
4FC	282	287	382	352	383	14	22	4	3	85.5	0.43	1.38	0.76	39.4
4EC	294	298	368	344	368	11	15	2.5	2	75	0.43	1.39	0.76	20
4FC	302	305	402	370	402	14	22	4	3	90.5	0.46	1.31	0.72	41.8
3FD	318	324	406	379	405	13	19	3	2.5	80	0.39	1.52	0.84	31.4
4GD	322	329	442	404	439	15	26	4	3	98	0.43	1.38	0.76	59.6

Note: When selecting bearings with bearing numbers marked with " * ", please consult NTN Engineering.

Metric series

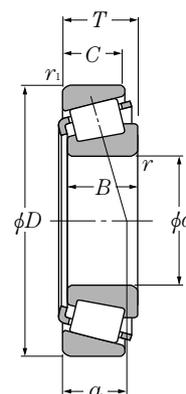

d 320 ~ 360mm

d	Boundary dimensions						Basic load ratings				Limiting speeds		Bearing numbers
	D	T	mm		$r_{s \min}^{1)}$	$r_{1s \min}^{1)}$	dynamic		static		grease	oil	
			B	C			kN	C_r	kgf	C_{or}			
320	440	76	76	57	4	3	1 010	2 150	103 000	219 000	670	900	* 32964XUE1
	440	76	72	63	3	3	865	1 880	88 000	192 000	670	900	32964E1 ²⁾
	480	100	100	74	5	4	1 520	2 940	155 000	300 000	630	840	32064XU
340	460	76	76	57	4	3	1 040	2 270	106 000	232 000	630	840	* 32968XUE1
	460	76	72	63	3	3	910	1 980	93 000	201 000	630	900	32968E1 ²⁾
360	480	76	76	57	4	3	1 050	2 330	107 000	238 000	590	780	32972XUE1

چرخ صنعت کشور

1) Minimal allowable dimension for chamfer dimension r or r_1 .
 2) This bearing does not incorporate the subunit dimensions.

Tapered Roller Bearings

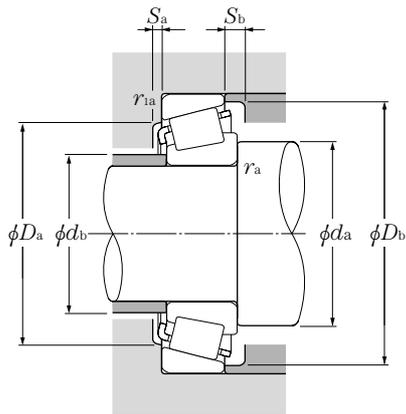

Equivalent radial load dynamic

$$P_r = X F_r + Y F_a$$

$\frac{F_a}{F_r} \leq e$		$\frac{F_a}{F_r} > e$	
X	Y	X	Y
1	0	0.4	Y ₂

static

$$P_{or} = 0.5 F_r + Y_0 F_a$$

When $P_{or} < F_r$ use $P_{or} = F_r$

For values of e , Y_2 and Y_0 see the table below.

Dimensions series to ISO	Abutment and fillet dimensions										Load center mm	Constant e	Axial load factors		Mass kg (approx.)
	d_a min	d_b max	D_a max	D_b min	S_a min	S_b min	r_{as} max	r_{1as} max	Y_2	Y_0					
3FD	338	344	426	398	426	13	19	3	2.5	85	0.42	1.44	0.79	33.1	
	338	344	426	398	425	13	13	3	2.5	85	0.39	1.55	0.85	31.7	
4GD	342	344.5	462	418.5	463	15	26	4	3	104	0.46	1.31	0.72	60.2	
4FD	358	362	446	417	446	13	19	3	2.5	90.5	0.44	1.37	0.75	34.9	
	358	362	446	414	445.5	13	13	3	2.5	87	0.39	1.55	0.85	36.0	
4FD	378	381	466	436	466	13	19	3	2.5	96.5	0.46	1.31	0.72	36.6	



Note: When selecting bearings with bearing numbers marked with " * ", please consult NTN Engineering.

Inch series

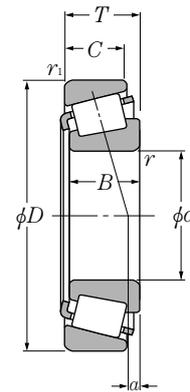

d 12.700 ~ 22.225mm

d	Boundary dimensions				dynamic kN	Basic load ratings		dynamic kgf	static kgf	Limiting speeds	
	D	T	B	C		static	dynamic			grease	oil
12.700	34.988	10.998	10.988	8.730	12.3	11.6	1 260	1 180	12 000	16 000	
14.989	34.988	10.998	10.988	8.730	12.3	11.6	1 260	1 180	12 000	16 000	
15.875	41.275	14.288	14.681	11.112	20.3	18.7	2 070	1 910	10 000	13 000	
	42.862	14.288	14.288	9.525	17.6	17.5	1 800	1 790	8 700	12 000	
	42.862	16.670	16.670	13.495	26.7	26.0	2 720	2 650	9 800	13 000	
	47.000	14.381	14.381	11.112	24.0	24.2	2 440	2 460	8 600	11 000	
	49.225	19.845	21.539	14.288	38.5	39.0	3 900	3 950	8 500	11 000	
16.993	47.000	14.381	14.381	11.112	24.0	24.2	2 440	2 460	8 600	11 000	
17.462	39.878	13.843	14.605	10.668	23.8	24.2	2 420	2 470	10 000	13 000	
19.050	39.992	12.014	11.153	9.525	12.8	12.8	1 310	1 300	10 000	13 000	
	45.237	15.494	16.637	12.065	28.3	28.6	2 880	2 920	8 900	12 000	
	47.000	14.381	14.381	11.112	24.0	24.2	2 440	2 460	8 600	11 000	
	49.225	18.034	19.050	14.288	38.5	39.0	3 900	3 950	8 500	11 000	
	49.225	19.845	21.539	14.288	38.5	39.0	3 900	3 950	8 500	11 000	
	49.225	21.209	19.050	17.462	38.5	39.0	3 900	3 950	8 500	11 000	
	53.975	22.225	21.839	15.875	40.0	39.0	4 100	3 950	8 000	11 000	
56.896	19.368	19.837	15.875	42.5	46.5	4 350	4 750	7 200	9 600		
19.987	47.000	14.381	14.381	11.112	24.0	24.2	2 440	2 460	8 600	11 000	
20.000	50.005	13.495	14.260	9.525	26.0	27.9	2 650	2 850	7 500	10 000	
20.625	49.225	19.845	21.539	14.288	38.5	39.0	3 900	3 950	8 500	11 000	
20.638	49.225	19.845	19.845	15.875	37.5	39.0	3 800	3 950	8 200	11 000	
21.430	50.005	17.526	18.288	13.970	38.0	39.0	3 850	3 950	8 000	11 000	
21.986	45.974	15.494	16.637	12.065	29.6	34.0	3 000	3 450	8 400	11 000	
22.225	50.005	13.495	14.260	9.525	26.0	27.9	2 650	2 850	7 500	10 000	
	50.005	17.526	18.288	13.970	38.0	39.0	3 850	3 950	8 000	11 000	
	52.388	19.368	20.168	14.288	40.5	43.0	4 150	4 350	7 600	10 000	
	53.975	19.368	20.168	14.288	40.5	43.0	4 150	4 350	7 600	10 000	

Note: 1. Chamfer dimensions on the back face of the inner and outer rings of the bearing are larger than maximum values for installation dimensions r_{is} and r_{ias} .
 2. As for the maximum value for inner and outer ring diameters of bearings whose bearing numbers are marked with "+" (inner ring) and "++" (outer ring), the precision class is an integer for class 4 and class 2 bearings only.

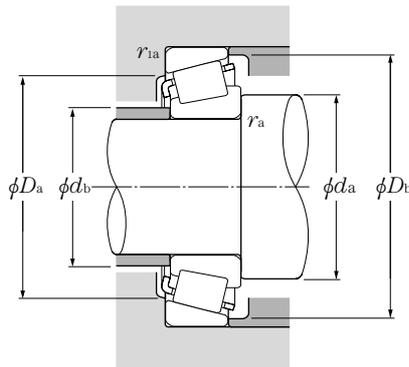

Equivalent radial load dynamic

$$P_r = XF_r + YF_a$$

$\frac{F_a}{F_r} \leq e$		$\frac{F_a}{F_r} > e$	
X	Y	X	Y
1	0	0.4	Y ₂

static

$$P_{or} = 0.5F_r + Y_0F_a$$

When $P_{or} < F_r$ use $P_{or} = F_r$

For values of e , Y_2 and Y_0 see the table below.

Bearing numbers	Abutment and fillet dimensions						Load center mm	Constant	Axial load factors		Mass kg
	mm								a	e	
	d_a	d_b	D_a	D_b	r_{as} max	r_{1as} max					(approx.)
4T-A4050/A4138	18.5	17	29	32	1.3	1.3	2.5	0.45	1.32	0.73	0.053
4T-A4059†/A4138	19.5	19	29	32	0.8	1.3	2.5	0.45	1.32	0.73	0.049
4T-03062/03162	21.5	20	34	37.5	1.3	2	5.4	0.31	1.93	1.06	0.092
4T-11590/11520	24.5	22.5	34.5	39.5	1.5	1.5	1.2	0.70	0.85	0.47	0.103
4T-17580/17520	23	21	36.5	39	1.5	1.5	5.8	0.33	1.81	1.00	0.122
4T-05062/05185	23.5	21	40.5	42.5	1.5	1.3	4.2	0.36	1.68	0.92	0.131
4T-09062/09195	22	21.5	42	44.5	0.8	1.3	9.4	0.27	2.26	1.24	0.203
4T-05066/05185	24.5	22	40.5	42.5	1.5	1.3	4.2	0.36	1.68	0.92	0.127
4T-LM11749/LM11710	23	21.5	34	37	1.3	1.3	5.3	0.29	2.10	1.15	0.084
4T-A6075/A6157	24	23	34	37	1	1.3	1.5	0.53	1.14	0.63	0.065
4T-LM11949/LM11910	28	23.5	39.5	41.5	1.3	1.3	5.6	0.30	2.00	1.10	0.122
4T-05075/05185	25	23.5	40.5	42.5	1.3	1.3	4.2	0.36	1.68	0.92	0.121
4T-09067/09195	25.5	24	42	44.5	1.3	1.3	7.6	0.27	2.26	1.24	0.179
4T-09078/09195	25.5	24	42	44.5	1.3	1.3	9.4	0.27	2.26	1.24	0.188
4T-09067/09196	25.5	24	41.5	44.5	1.3	1.5	7.6	0.27	2.26	1.24	0.198
4T-21075/21212††	31.5	26	43	50	1.5	2.3	5.6	0.59	1.02	0.56	0.248
4T-1775/1729	27	25	49	51	1.5	1.3	6.5	0.31	1.95	1.07	0.272
4T-05079†/05185	26.5	24	40.5	42.5	1.5	1.3	4.2	0.36	1.68	0.92	0.117
4T-07079/07196	27.5	26	44.5	47	1.5	1	3.0	0.40	1.49	0.82	0.138
4T-09081/09195	27.5	25.5	42	44.5	1.5	1.3	9.4	0.27	2.26	1.24	0.179
4T-12580/12520	28.5	26	42.5	45.5	1.5	1.5	7.1	0.32	1.86	1.02	0.182
4T-M12649/M12610	29	25.5	44	46	1.3	1.3	6.4	0.28	2.16	1.19	0.169
4T-LM12749†/LM12711††	27.5	26	40	42.5	1.3	1.3	5.4	0.31	1.96	1.08	0.123
4T-07087/07196	28.5	27	44.5	47	1.3	1	3.0	0.40	1.49	0.82	0.13
4T-M12648/M12610	28.5	26.5	44	46	1.3	1.3	6.4	0.28	2.16	1.19	0.165
4T-1380/1328	29.5	27	45	48.5	1.5	1.5	7.4	0.29	2.05	1.13	0.2
4T-1380/1329††	29.5	27	46	49	1.5	1.5	7.4	0.29	2.05	1.13	0.215

Inch series

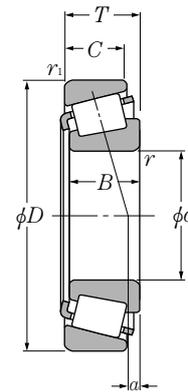

d 22.225 ~ 28.575mm

d	Boundary dimensions				dynamic kN	Basic load ratings			Limiting speeds	
	D	T	B	C		static	dynamic	static	grease	oil
	mm						kgf		min ⁻¹	
					C _r	C _{or}	C _r	C _{or}		
22.225	56.896	19.368	19.837	15.875	42.5	46.5	4 350	4 750	7 200	9 600
	57.150	22.225	22.225	17.462	47.0	49.5	4 800	5 050	7 100	9 500
22.606	47.000	15.500	15.500	12.000	27.5	32.5	2 800	3 300	8 200	11 000
23.812	50.005	13.495	14.260	9.525	26.0	27.9	2 650	2 850	7 500	10 000
	50.292	14.224	14.732	10.668	28.8	34.0	2 940	3 450	7 400	9 900
	56.896	19.368	19.837	15.875	42.5	46.5	4 350	4 750	7 200	9 600
24.981	50.005	13.495	14.260	9.525	26.0	27.9	2 650	2 850	7 500	10 000
25.000	50.005	13.495	14.260	9.525	26.0	27.9	2 650	2 850	7 500	10 000
25.159	50.005	13.495	14.260	9.525	26.0	27.9	2 650	2 850	7 500	10 000
25.400	50.005	13.495	14.260	9.525	26.0	27.9	2 650	2 850	7 500	10 000
	50.005	13.495	14.260	9.525	26.0	27.9	2 650	2 850	7 500	10 000
	50.292	14.224	14.732	10.668	28.8	34.0	2 940	3 450	7 400	9 900
	51.994	15.011	14.260	12.700	26.0	27.9	2 650	2 850	7 500	10 000
	56.896	19.368	19.837	15.875	42.5	46.5	4 350	4 750	7 200	9 600
	57.150	19.431	19.431	14.732	42.0	48.5	4 300	4 950	6 900	9 200
	61.912	19.050	20.638	14.288	46.5	54.0	4 750	5 500	6 100	8 200
	62.000	19.050	20.638	14.288	46.5	54.0	4 750	5 500	6 100	8 200
	62.000	19.050	20.638	14.288	46.5	54.0	4 750	5 500	6 100	8 200
64.292	21.433	21.433	16.670	51.5	64.5	5 250	6 600	6 100	8 100	
65.088	22.225	21.463	15.875	47.0	50.5	4 800	5 150	5 700	7 600	
66.421	23.812	25.433	19.050	64.5	72.5	6 550	7 400	6 200	8 200	
26.157	62.000	19.050	20.638	14.288	46.5	54.0	4 750	5 500	6 100	8 200
26.162	66.421	23.812	25.433	19.050	64.5	72.5	6 550	7 400	6 200	8 200
26.988	50.292	14.224	14.732	10.668	28.8	34.0	2 940	3 450	7 400	9 900
	60.325	19.842	17.462	15.875	39.5	45.5	4 050	4 650	6 700	8 900
	62.000	19.050	20.638	14.288	46.5	54.0	4 750	5 500	6 100	8 200
	66.421	23.812	25.433	19.050	64.5	72.5	6 550	7 400	6 200	8 200
28.575	56.896	19.845	19.355	15.875	40.5	44.5	4 150	4 550	6 700	8 900
	57.150	17.462	17.462	13.495	39.5	45.5	4 050	4 650	6 700	8 900

Note: 1. Chamfer dimensions on the back face of the inner and outer rings of the bearing are larger than maximum values for installation dimensions r_{as} and r_{1as} .
 2. As for the maximum value for inner ring bore diameters of bearings whose bearing numbers are marked with "+" (inner ring), the precision class is an integer for class 4 and class 2 bearings only.

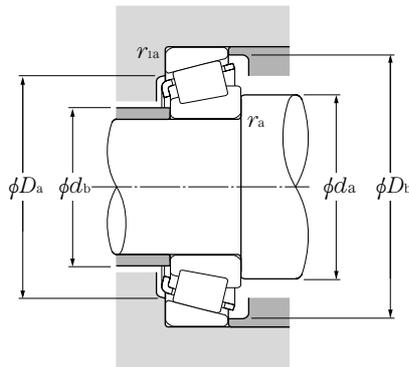

Equivalent radial load dynamic

$$P_r = XF_r + YF_a$$

$\frac{F_a}{F_r} \leq e$		$\frac{F_a}{F_r} > e$	
X	Y	X	Y
1	0	0.4	Y_2

static

$$P_{or} = 0.5F_r + Y_oF_a$$

When $P_{or} < F_r$ use $P_{or} = F_r$

For values of e , Y_2 and Y_o see the table below.

Bearing numbers	Abutment and fillet dimensions						Load center mm	Constant e	Axial load factors		Mass kg (approx.)
	d_a	d_b	D_a	D_b	r_{as} max	r_{1as} max			Y_2	Y_o	
4T-1755/1729	29	27.5	49	51	1.3	1.3	6.5	0.31	1.95	1.07	0.256
4T-1280/1220	29.5	29	49	52	0.8	1.5	7.1	0.35	1.73	0.95	0.286
4T-LM72849/LM72810	30	28	40.5	44	1.5	1	3.0	0.47	1.27	0.70	0.125
4T-07093/07196	30.5	28.5	44.5	47	1.5	1	3.0	0.40	1.49	0.82	0.123
4T-L44640/L44610	30.5	28.5	44.5	47	1.5	1.3	3.4	0.37	1.60	0.88	0.137
4T-1779/1729	29.5	28.5	49	51	0.8	1.3	6.5	0.31	1.95	1.07	0.247
4T-07098/07196	31	29	44.5	47	1.5	1	3.0	0.40	1.49	0.82	0.118
4T-07097/07196	31	29	44.5	47	1.5	1	3.0	0.40	1.49	0.82	0.118
4T-07096/07196	31.5	29.5	44.5	47	1.5	1	3.0	0.40	1.49	0.82	0.117
4T-07100/07196	30.5	29.5	44.5	47	1	1	3.0	0.40	1.49	0.82	0.117
4T-07100S/07196	31.5	29.5	44.5	47	1.5	1	3.0	0.40	1.49	0.82	0.116
4T-L44643/L44610	31.5	29.5	44.5	47	1.3	1.3	3.4	0.37	1.60	0.88	0.13
4T-07100/07204	30.5	29.5	45	48	1	1.3	3.0	0.40	1.49	0.82	0.144
4T-1780/1729	30.5	30	49	51	0.8	1.3	6.5	0.31	1.95	1.07	0.238
4T-M84548/M84510	36	33	48.5	54	1.5	1.5	3.4	0.55	1.10	0.60	0.241
4T-15101/15243	32.5	31.5	54	58	0.8	2	6.0	0.35	1.71	0.94	0.3
4T-15100/15245	38	31.5	55	58	3.5	1.3	6.0	0.35	1.71	0.94	0.299
4T-15102/15245	34	31.5	55	58	1.5	1.3	6.0	0.35	1.71	0.94	0.301
4T-M86643/M86610	38	36.5	54	61	1.5	1.5	3.3	0.55	1.10	0.60	0.371
4T-23100/23256	39	34.5	53	63	1.5	1.5	2.0	0.73	0.82	0.45	0.36
4T-2687/2631	33.5	31.5	58	60	1.3	1.3	9.3	0.25	2.36	1.30	0.442
4T-15103/15245	33	32.5	55	58	0.8	1.3	6.0	0.35	1.71	0.94	0.296
4T-2682/2631	34.5	32	58	60	1.5	1.3	9.3	0.25	2.36	1.30	0.436
4T-L44649†/L44610	37.5	31	44.5	47	3.5	1.3	3.4	0.37	1.60	0.88	0.12
4T-15580†/15523	38.5	32	51	54	3.5	1.5	5.0	0.35	1.73	0.95	0.26
4T-15106†/15245	33.5	33	55	58	0.8	1.3	6.0	0.35	1.71	0.94	0.291
4T-2688†/2631	35	33	58	60	1.5	1.3	9.3	0.25	2.36	1.30	0.429
4T-1985/1930	34	33.5	51	54	0.8	0.8	6.7	0.33	1.82	1.00	0.217
4T-15590/15520	39.5	33.5	51	53	3.5	1.5	5.0	0.35	1.73	0.95	0.196

Tapered Roller Bearings

Inch series
J series

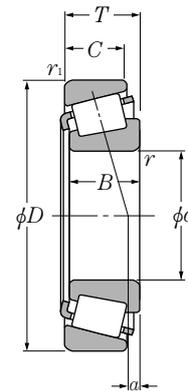

d 28.575 ~ 31.750mm

d	Boundary dimensions				dynamic kN	Basic load ratings			Limiting speeds	
	D	T	B	C		static	dynamic	static	grease	oil
	mm						kgf		min ⁻¹	
					C _r	C _{or}	C _r	C _{or}		
28.575	58.738	19.050	19.355	15.080	40.5	44.5	4 150	4 550	6 700	8 900
	60.325	19.842	17.462	15.875	39.5	45.5	4 050	4 650	6 700	8 900
	60.325	19.845	19.355	15.875	40.5	44.5	4 150	4 550	6 700	8 900
	62.000	19.050	20.638	14.288	46.5	54.0	4 750	5 500	6 100	8 200
	64.292	21.433	21.433	16.670	51.5	64.5	5 250	6 600	6 100	8 100
	66.421	23.812	25.433	19.050	64.5	72.5	6 550	7 400	6 200	8 200
	68.262	22.225	22.225	17.462	57.0	67.0	5 800	6 850	5 800	7 700
	68.262	22.225	23.812	17.462	57.5	65.5	5 850	6 700	5 700	7 700
	69.850	23.812	25.357	19.050	69.0	81.5	7 050	8 300	5 700	7 600
	72.626	24.608	24.257	17.462	58.0	55.5	5 900	5 700	5 800	7 700
73.025	22.225	22.225	17.462	56.5	68.0	5 750	6 900	5 300	7 000	
29.000	50.292	14.224	14.732	10.668	28.0	35.5	2 860	3 600	7 200	9 600
29.367	66.421	23.812	25.433	19.050	64.5	72.5	6 550	7 400	6 200	8 200
29.987	62.000	16.002	16.566	14.288	39.0	42.0	3 950	4 300	6 300	8 400
	62.000	19.050	20.638	14.288	46.5	54.0	4 750	5 500	6 100	8 200
30.000	69.012	19.845	19.583	15.875	48.5	58.0	4 900	5 900	5 600	7 400
	72.000	29.370	27.783	23.020	72.0	97.0	7 350	9 850	5 400	7 100
30.112	62.000	19.050	20.638	14.288	46.5	54.0	4 750	5 500	6 100	8 200
30.162	62.000	16.002	16.566	14.288	39.0	42.0	3 950	4 300	6 300	8 400
	64.292	21.433	21.433	16.670	51.5	64.5	5 250	6 600	6 100	8 100
	69.850	23.812	25.357	19.050	69.0	81.5	7 050	8 300	5 700	7 600
	72.626	30.162	29.997	23.812	84.5	98.0	8 600	9 950	5 500	7 300
30.213	62.000	19.050	20.638	14.288	46.5	54.0	4 750	5 500	6 100	8 200
	62.000	19.050	20.638	14.288	46.5	54.0	4 750	5 500	6 100	8 200
	62.000	19.050	20.638	14.288	46.5	54.0	4 750	5 500	6 100	8 200
30.226	69.012	19.845	19.583	15.875	48.5	58.0	4 900	5 900	5 600	7 400
	69.012	19.845	19.583	15.875	48.5	58.0	4 900	5 900	5 600	7 400
31.750	59.131	15.875	16.764	11.811	34.5	41.0	3 500	4 150	6 300	8 400
	62.000	18.161	19.050	14.288	46.5	54.0	4 750	5 500	6 100	8 200
	62.000	19.050	20.638	14.288	46.5	54.0	4 750	5 500	6 100	8 200

Note: 1. Chamfer dimensions on the back face of the inner and outer rings of the bearing are larger than maximum values for installation dimensions r_{as} and r_{1as} .
 2. As for the maximum value for inner ring bore diameters of bearings whose bearing numbers are marked with "+" (inner ring), the precision class is an integer for class 4 and class 2 bearings only.

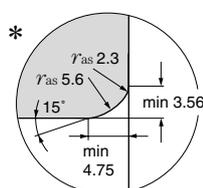
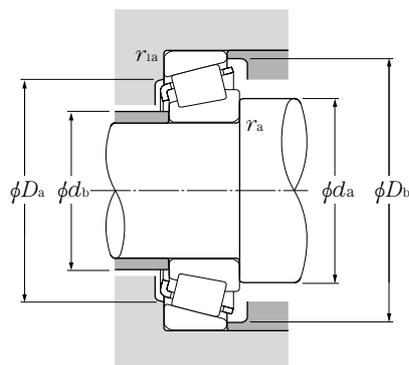

Equivalent radial load dynamic

$$P_r = XF_r + YF_a$$

$\frac{F_a}{F_r} \leq e$		$\frac{F_a}{F_r} > e$	
X	Y	X	Y
1	0	0.4	Y_2

static

$$P_{or} = 0.5F_r + Y_0F_a$$

When $P_{or} < F_r$ use $P_{or} = F_r$

For values of e , Y_2 and Y_0 see the table below.

Bearing numbers	Abutment and fillet dimensions						Load center mm	Constant e	Axial load factors		Mass kg (approx.)
	d_a	d_b	D_a	D_b	r_{as} max	r_{1as} max			Y_2	Y_0	
4T-1985/1932	34	33.5	52	54	0.8	1.3	5.9	0.33	1.82	1.00	0.23
4T-15590/15523	39.5	33.5	51	54	3.5	1.5	5.0	0.35	1.73	0.95	0.25
4T-1985/1931	34	33.5	52	55	0.8	1.3	5.9	0.33	1.82	1.00	0.255
4T-15112/15245	40	34	55	58	3.5	1.3	6.0	0.35	1.71	0.94	0.277
4T-M86647/M86610	40	38	54	61	1.5	1.5	3.3	0.55	1.10	0.60	0.348
4T-2689/2631	36	34	58	60	1.3	1.3	9.3	0.25	2.36	1.30	0.416
4T-02474/02420	36.5	36	59	63	0.8	1.5	5.2	0.42	1.44	0.79	0.409
4T-2474/2420	36	35	60	63	0.8	1.5	6.5	0.34	1.77	0.97	0.41
4T-2578/2523	39	35	61	64	2.3	1.3	9.1	0.27	2.19	1.21	0.483
4T-41125/41286	48	36.5	61	68	4.8	1.5	3.7	0.60	1.00	0.55	0.477
4T-02872/02820	37.5	37	62	68	0.8	3.3	3.9	0.45	1.32	0.73	0.48
4T-L45449/L45410	39.5	33	44.5	48	3.5	1.3	3.5	0.37	1.62	0.89	0.113
4T-2690/2631	41	35	58	60	3.5	1.3	9.3	0.25	2.36	1.30	0.406
4T-17118†/17244	37	34.5	54	57	1.5	1.5	3.3	0.38	1.57	0.86	0.228
4T-15117†/15245	36.5	35	55	58	1.3	1.3	6.0	0.35	1.71	0.94	0.269
4T-14117A/14276	42.5	39.5	60	63	3.5	1.3	4.1	0.38	1.57	0.86	0.369
# 4T-JHM88540/JHM88513	44.5	42.5	58	69	1.3	3.3	6.0	0.55	1.10	0.60	0.619
4T-15116/15245	36	35.5	55	58	0.8	1.3	6.0	0.35	1.71	0.94	0.268
4T-17119/17244	37	34.5	54	57	1.5	1.5	3.3	0.38	1.57	0.86	0.226
4T-M86649/M86610	41	38	54	61	1.5	1.5	3.3	0.55	1.10	0.60	0.336
4T-2558/2523	40	36.5	61	64	2.3	1.3	9.1	0.27	2.19	1.21	0.468
4T-3187/3120	39	38.5	61	67	0.8	3.3	9.9	0.33	1.80	0.99	0.621
4T-15118/15245	41.5	35.5	55	58	3.5	1.3	6.0	0.35	1.71	0.94	0.265
4T-15119/15245	37.5	35.5	55	58	1.5	1.3	6.0	0.35	1.71	0.94	0.267
4T-15120/15245	36	35.5	55	58	0.8	1.3	6.0	0.35	1.71	0.94	0.267
4T-14116/14274	37	36.5	59	63	0.8	3.3	4.1	0.38	1.57	0.86	0.366
4T-14116/14276	37	36.5	60	63	0.8	1.3	4.1	0.38	1.57	0.86	0.37
4T-LM67048/LM67010	42.5	36	52	56	*	1.3	2.8	0.41	1.46	0.80	0.182
4T-15123/15245	42.5	36.5	55	58	*	1.3	5.1	0.35	1.71	0.94	0.244
4T-15125/15245	42.5	36.5	55	58	3.5	1.3	6.0	0.35	1.71	0.94	0.253

Note: 3. Bearing numbers marked " # " designate J-series bearings. The tolerances of these bearings is listed in Table 6.6 on page A-42.

4. Chamfer dimensions of bearings marked " * " are shown in drawings.

Tapered Roller Bearings

Inch series
J series

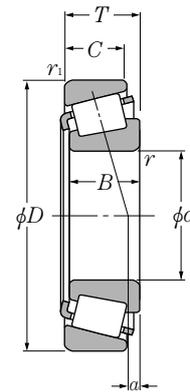

d 31.750 ~ 34.925mm

d	Boundary dimensions				dynamic kN	Basic load ratings			Limiting speeds	
	D	T	B	C		static	dynamic	static	grease	oil
	mm						kgf		min ⁻¹	
31.750	62.000	19.050	20.638	14.288	46.5	54.0	4 750	5 500	6 100	8 200
	66.421	25.400	25.357	20.638	69.0	81.5	7 050	8 300	5 700	7 600
	68.262	22.225	22.225	17.462	57.0	67.0	5 800	6 850	5 800	7 700
	68.262	22.225	22.225	17.462	57.0	67.0	5 800	6 850	5 800	7 700
	69.012	19.845	19.583	15.875	48.5	58.0	4 900	5 900	5 600	7 400
	69.012	19.845	19.583	15.875	48.5	58.0	4 900	5 900	5 600	7 400
	69.850	23.812	25.357	19.050	69.0	81.5	7 050	8 300	5 700	7 600
	69.850	23.812	25.357	19.050	69.0	81.5	7 050	8 300	5 700	7 600
	72.626	30.162	29.997	23.812	84.5	98.0	8 600	9 950	5 500	7 300
	72.626	30.162	29.997	23.812	84.5	98.0	8 600	9 950	5 500	7 300
	73.025	22.225	22.225	17.462	56.5	68.0	5 750	6 900	5 300	7 000
	73.025	22.225	23.812	17.462	62.5	75.5	6 400	7 700	5 200	7 000
	73.025	29.370	27.783	23.020	72.0	97.0	7 350	9 850	5 400	7 100
	73.812	29.370	27.783	23.020	72.0	97.0	7 350	9 850	5 400	7 100
	76.200	29.370	28.575	23.020	78.0	105	7 950	10 700	5 100	6 800
	79.375	29.370	29.771	23.812	93.0	114	9 450	11 600	4 900	6 600
33.338	68.262	22.225	22.225	17.462	56.5	71.0	5 750	7 250	5 700	7 500
	69.012	19.845	19.583	15.875	48.5	58.0	4 900	5 900	5 600	7 400
	69.850	23.812	25.357	19.050	69.0	81.5	7 050	8 300	5 700	7 600
	72.626	30.162	29.997	23.812	84.5	98.0	8 600	9 950	5 500	7 300
	73.025	29.370	27.783	23.020	72.0	97.0	7 350	9 850	5 400	7 100
	76.200	23.812	25.654	19.050	73.0	90.5	7 450	9 200	5 100	6 800
	76.200	29.370	28.575	23.020	78.0	105	7 950	10 700	5 100	6 800
	76.200	29.370	28.575	23.020	78.0	105	7 950	10 700	5 100	6 800
34.925	65.088	18.034	18.288	13.970	46.5	56.0	4 750	5 700	5 700	7 600
	65.088	18.034	18.288	13.970	46.5	56.0	4 750	5 700	5 700	7 600
	69.012	19.845	19.583	15.875	48.5	58.0	4 900	5 900	5 600	7 400
	72.233	25.400	25.400	19.842	65.0	84.5	6 600	8 600	5 400	7 200
	72.238	20.638	20.638	15.875	48.0	58.5	4 900	5 950	5 300	7 000
	73.025	22.225	22.225	17.462	56.5	68.0	5 750	6 900	5 300	7 000
	73.025	22.225	22.225	17.462	56.5	68.0	5 750	6 900	5 300	7 000
	73.025	22.225	23.812	17.462	62.5	75.5	6 400	7 700	5 200	7 000
	73.025	23.812	24.608	19.050	71.0	85.0	7 200	8 700	5 300	7 100
	73.025	23.812	24.608	19.050	71.0	85.0	7 200	8 700	5 300	7 100
	73.025	23.812	25.654	19.050	73.0	90.5	7 450	9 200	5 100	6 800
	76.200	23.812	25.654	19.050	73.0	90.5	7 450	9 200	5 100	6 800

Note: 1. Chamfer dimensions on the back face of the inner and outer rings of the bearing are larger than maximum values for installation dimensions r_{as} and r_{ias} .
2. Chamfer dimensions of bearings marked " * " are shown in drawings.

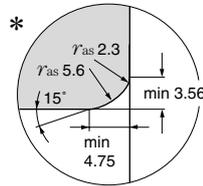
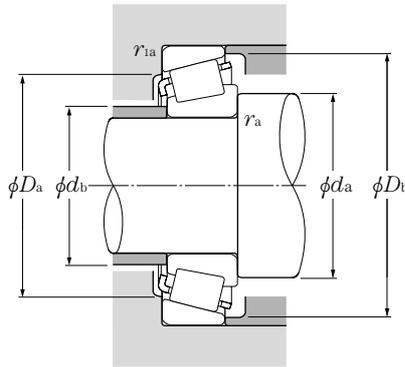

Equivalent radial load dynamic

$$P_r = XF_r + YF_a$$

$\frac{F_a}{F_r} \leq e$		$\frac{F_a}{F_r} > e$	
X	Y	X	Y
1	0	0.4	Y ₂

static

$$P_{or} = 0.5F_r + Y_0F_a$$

When $P_{or} < F_r$ use $P_{or} = F_r$

For values of e , Y_2 and Y_0 see the table below.

Bearing numbers	Abutment and fillet dimensions						Load center mm	Constant e	Axial load factors		Mass kg (approx.)
	d_a	d_b	D_a	D_b	r_{as} max	r_{1as} max			Y_2	Y_0	
4T-15126/15245	37	36.5	55	58	0.8	1.3	6.0	0.35	1.71	0.94	0.255
4T-2580/2520	38.5	37.5	57	62	0.8	3.3	9.1	0.27	2.19	1.21	0.409
4T-02475/02420	44.5	38.5	59	63	3.5	1.5	5.2	0.42	1.44	0.79	0.38
4T-02476/02420	39	38.5	59	63	0.8	1.5	5.2	0.42	1.44	0.79	0.383
4T-14124/14276	38.5	37.5	60	63	0.8	1.3	4.1	0.38	1.57	0.86	0.359
4T-14125A/14276	44	37.5	60	63	3.5	1.3	4.1	0.38	1.57	0.86	0.356
4T-2580/2523	38.5	37.5	61	64	0.8	1.3	9.1	0.27	2.19	1.21	0.454
4T-2582/2523	44	37.5	61	64	3.5	1.3	9.1	0.27	2.19	1.21	0.451
4T-3188/3120	40	39.5	61	67	0.8	3.3	9.9	0.33	1.80	0.99	0.603
4T-3193/3120	45.5	39.5	61	67	3.5	3.3	9.9	0.33	1.80	0.99	0.601
4T-02875/02820	45.5	39.5	62	68	3.5	3.3	3.9	0.45	1.32	0.73	0.451
4T-2879/2820	39.5	38.5	63	68	0.8	3.3	5.5	0.37	1.63	0.90	0.465
4T-HM88542/HM88510	45.5	42.5	59	70	1.3	3.3	6.0	0.55	1.10	0.60	0.622
4T-HM88542/HM88512	45.5	42.5	60	70	1.3	3.3	6.0	0.55	1.10	0.60	0.638
4T-HM89440/HM89410	45.5	44.5	62	73	0.8	3.3	5.8	0.55	1.10	0.60	0.686
4T-3476/3420	43	41	67	74	1.3	3.3	8.7	0.37	1.64	0.90	0.767
4T-M88048/M88010	42.5	41	58	65	0.8	1.5	2.9	0.55	1.10	0.60	0.378
4T-14130/14276	45	38.5	60	63	3.5	1.3	4.1	0.38	1.57	0.86	0.344
4T-2585/2523	45	39	61	64	3.5	1.3	9.1	0.27	2.19	1.21	0.435
4T-3196/3120	47	40.5	61	67	3.5	3.3	9.9	0.33	1.80	0.99	0.581
4T-HM88547/HM88510	45.5	42.5	59	70	0.8	3.3	6.0	0.55	1.10	0.60	0.604
4T-2785/2720	46	40	66	70	3.5	3.3	7.8	0.30	1.98	1.09	0.551
4T-HM89443/HM89410	46.5	44.5	62	73	0.8	3.3	5.8	0.55	1.10	0.60	0.668
4T-HM89444/HM89410	53	44.5	62	73	3.8	3.3	5.8	0.55	1.10	0.60	0.665
4T-43131/43312	51	42	67	74	3.5	1.5	1.4	0.67	0.90	0.49	0.568
4T-LM48548/LM48510	46	40	58	61	*	1.3	3.7	0.38	1.59	0.88	0.249
4T-LM48548A/LM48510	40.5	42	58	61	0.8	1.3	3.7	0.38	1.59	0.88	0.252
4T-14137A/14276	42	40	60	63	1.5	1.3	4.1	0.38	1.57	0.86	0.333
4T-HM88649/HM88610	48.5	42.5	60	69	2.3	2.3	4.6	0.55	1.10	0.60	0.489
4T-16137/16284	47	40.5	63	67	3.5	1.3	4.2	0.40	1.49	0.82	0.385
4T-02877/02820	48.5	42	62	68	3.5	3.3	3.9	0.45	1.32	0.73	0.422
4T-02878/02820	42.5	42	62	68	0.8	3.3	3.9	0.45	1.32	0.73	0.425
4T-2878/2820	42	41	63	68	0.8	3.3	5.5	0.37	1.63	0.90	0.434
4T-25877/25820	43	40.5	64	68	1.5	2.3	8.1	0.29	2.07	1.14	0.471
4T-25877/25821	43	40.5	65	68	1.5	0.8	8.1	0.29	2.07	1.14	0.474
4T-2793/2735X	42	41	66	69	0.8	0.8	7.8	0.30	1.98	1.09	0.485
4T-2793/2720	42	41	66	70	0.8	3.3	7.8	0.30	1.98	1.09	0.536

Inch series
J series

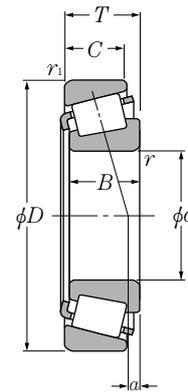

d 34.925 ~ 38.100mm

d	Boundary dimensions				dynamic kN	Basic load ratings			Limiting speeds	
	D	T	B	C		static	dynamic	static	grease	oil
	mm						kgf		min ⁻¹	
					C _r	C _{or}	C _r	C _{or}		
34.925	76.200	23.812	25.654	19.050	73.0	90.5	7 450	9 200	5 100	6 800
	76.200	29.370	28.575	23.020	78.0	105	7 950	10 700	5 100	6 800
	76.200	29.370	28.575	23.812	80.5	97.0	8 200	9 900	5 100	6 800
	76.200	29.370	28.575	23.812	80.5	97.0	8 200	9 900	5 100	6 800
	79.375	29.370	29.771	23.812	93.0	114	9 450	11 600	4 900	6 600
	80.167	29.370	30.391	23.812	95.0	112	9 700	11 400	4 800	6 400
	85.725	30.162	30.162	23.812	105	132	10 700	13 400	4 500	6 000
34.976	69.012	19.845	19.583	15.875	48.5	58.0	4 900	5 900	5 600	7 400
34.988	59.974	15.875	16.764	11.938	35.5	47.5	3 600	4 850	6 100	8 100
	61.973	16.700	17.000	13.600	37.0	48.0	3 800	4 900	5 900	7 900
	61.973	18.000	17.000	15.000	37.0	48.0	3 800	4 900	5 900	7 900
35.000	70.000	24.000	23.500	19.000	62.0	78.0	6 350	7 950	5 500	7 300
	79.375	23.812	25.400	19.050	76.5	97.5	7 800	9 950	4 800	6 400
	80.000	21.000	22.403	17.826	68.0	75.0	6 950	7 650	4 700	6 300
35.717	72.233	25.400	25.400	19.842	65.0	84.5	6 600	8 600	5 400	7 200
	72.626	25.400	25.400	19.842	65.0	84.5	6 600	8 600	5 400	7 200
36.487	73.025	23.812	24.608	19.050	71.0	85.0	7 200	8 700	5 300	7 100
	76.200	23.812	25.654	19.050	73.0	90.5	7 450	9 200	5 100	6 800
36.512	76.200	29.370	28.575	23.020	78.0	105	7 950	10 700	5 100	6 800
	76.200	29.370	28.575	23.020	78.0	105	7 950	10 700	5 100	6 800
	76.200	29.370	28.575	23.812	80.5	97.0	8 200	9 900	5 100	6 800
	79.375	29.370	28.829	22.664	86.5	104	8 800	10 600	5 000	6 600
	79.375	29.370	29.771	23.812	93.0	114	9 450	11 600	4 900	6 600
	88.500	25.400	23.698	17.462	70.5	78.0	7 200	7 950	4 000	5 300
38.000	63.000	17.000	17.000	13.500	38.5	52.5	3 950	5 350	5 700	7 600
38.100	63.500	12.700	11.908	9.525	25.9	33.5	2 640	3 400	5 500	7 300
	65.088	18.034	18.288	13.970	43.5	57.0	4 400	5 800	5 500	7 400
	69.012	19.050	19.050	15.083	47.5	59.5	4 850	6 050	5 300	7 100
	69.012	19.050	19.050	15.083	47.5	59.5	4 850	6 050	5 300	7 100
	71.438	15.875	16.520	11.908	43.5	51.0	4 400	5 200	5 400	7 200
	72.000	19.000	20.638	14.237	48.0	58.5	4 900	5 950	5 300	7 000

Note: 1. Chamfer dimensions on the back face of the inner and outer rings of the bearing are larger than maximum values for installation dimensions r_{is} and r_{ios} .
 2. As for the maximum value for inner and outer ring diameters of bearings whose bearing numbers are marked with "+" (inner ring) and "++" (outer ring), the precision class is an integer for class 4 and class 2 bearings only.

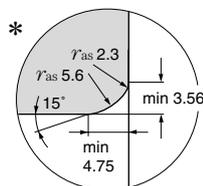
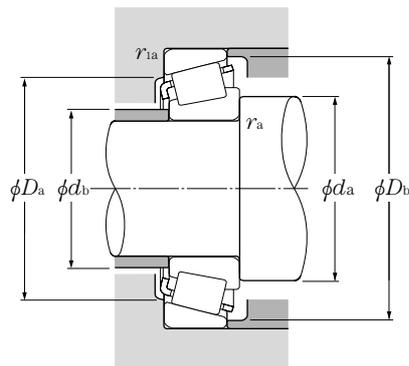

Equivalent radial load dynamic

$$P_r = XF_r + YF_a$$

$\frac{F_a}{F_r} \leq e$		$\frac{F_a}{F_r} > e$	
X	Y	X	Y
1	0	0.4	Y_2

static

$$P_{or} = 0.5F_r + Y_0F_a$$

When $P_{or} < F_r$ use $P_{or} = F_r$

For values of e , Y_2 and Y_0 see the table below.

Bearing numbers	Abutment and fillet dimensions						Load center mm	Constant e	Axial load factors		Mass kg (approx.)
	d_a	d_b	D_a	D_b	r_{as} max	r_{1as} max			Y_2	Y_0	
4T-2793/2729	42	41	68	70	0.8	0.8	7.8	0.30	1.98	1.09	0.541
4T-HM89446/HM89410	53	44.5	62	73	3.5	3.3	5.8	0.55	1.10	0.60	0.646
4T-31593/31520	50	43.5	64	72	3.5	3.3	7.8	0.40	1.49	0.82	0.625
4T-31594/31520	46	43.5	64	72	1.5	3.3	7.8	0.40	1.49	0.82	0.627
4T-3478/3420	50	43.5	67	74	3.5	3.3	8.7	0.37	1.64	0.90	0.725
4T-3379/3320	48	41.5	70	75	3.5	3.3	11.2	0.27	2.20	1.21	0.732
4T-3872/3820	53	46	73	81	3.5	3.3	8.1	0.40	1.49	0.82	0.897
4T-14139/14276	41.5	40	60	63	1.3	1.3	4.1	0.38	1.57	0.86	0.333
4T-L68149†/L68111††	45.5	39	53	56	*	1.3	2.5	0.42	1.44	0.79	0.179
4T-LM78349A†/LM78310A††	42	39.5	54	59	1.5	1.5	2.4	0.44	1.35	0.74	0.209
4T-LM78349†/LM78310C††	46	40	56	59	*	1.5	2.4	0.44	1.35	0.74	0.218
# 4T-JS3549A/JS3510	47	42	60	67	2	1.5	3.6	0.55	1.10	0.60	0.42
4T-26883/26822	42.5	42	71	74	0.8	0.8	7.4	0.32	1.88	1.04	0.61
4T-339/332	42.5	41.5	73	75	0.8	1.3	6.6	0.27	2.20	1.21	0.534
4T-HM88648/HM88610	52	43	60	69	3.5	2.3	4.6	0.55	1.10	0.60	0.478
4T-HM88648/HM88611AS	52	43	59	69	3.5	3.3	3.0	0.55	1.10	0.60	0.482
4T-25880/25821	44	42	65	68	1.5	0.8	8.1	0.29	2.07	1.14	0.457
4T-2780/2720	44.5	42.5	66	70	1.5	3.3	7.8	0.30	1.98	1.09	0.518
4T-HM89448/HM89410	48.5	44.5	62	73	0.8	3.3	5.8	0.55	1.10	0.60	0.629
4T-HM89449/HM89411	54	44.5	65	73	3.5	0.8	5.8	0.55	1.10	0.60	0.631
4T-31597/31520	51	44.5	64	72	3.5	3.3	7.8	0.40	1.49	0.82	0.605
4T-HM89249/HM89210	55	44	66	75	3.5	3.3	5.8	0.55	1.10	0.60	0.686
4T-3479/3420	45.5	44.5	67	74	0.8	3.3	8.7	0.37	1.64	0.90	0.707
4T-44143/44348	54	50	75	84	2.3	1.5	-2.9	0.78	0.77	0.42	0.729
# 4T-JL69349/JL69310	49	42.5	56	60	*	1.3	2.3	0.42	1.44	0.79	0.198
4T-13889/13830	45	42.5	59	60	1.5	0.8	0.8	0.35	1.73	0.95	0.147
4T-LM29748/LM29710	49	42.5	59	62	*	1.3	4.3	0.33	1.80	0.99	0.233
4T-13685/13621	49.5	43	61	65	3.5	2.3	3.0	0.40	1.49	0.82	0.293
4T-13687/13621	46.5	43	61	65	2	2.3	3.0	0.40	1.49	0.82	0.296
4T-19150/19281	45	43	63	66	1.5	1	1.4	0.44	1.35	0.74	0.273
4T-16150/16282	49.5	43	63	67	3.5	1.5	4.2	0.40	1.49	0.82	0.331

Note: 3. Bearing numbers marked " # " designate J-series bearings. The tolerances of these bearings is listed in Table 6.6 on page A-42.

4. Chamfer dimensions of bearings marked " * " are shown in drawings.

Inch series

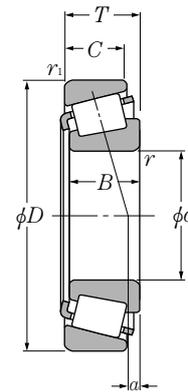

d 38.100 ~ 41.275mm

d	Boundary dimensions				dynamic kN	Basic load ratings			Limiting speeds	
	D	T	B	C		static	dynamic	static	grease	oil
	mm						kgf		min ⁻¹	
	D	T	B	C	C _r	C _{or}	C _r	C _{or}	grease	oil
38.100	76.200	20.638	20.940	15.507	55.5	63.0	5 650	6 450	5 000	6 700
	76.200	23.812	25.654	19.050	73.0	90.5	7 450	9 200	5 100	6 800
	76.200	23.812	25.654	19.050	73.0	90.5	7 450	9 200	5 100	6 800
	79.375	23.812	25.400	19.050	76.5	97.5	7 800	9 950	4 800	6 400
	79.375	29.370	29.771	23.812	93.0	114	9 450	11 600	4 900	6 600
	80.000	21.006	20.940	15.875	55.5	63.0	5 650	6 450	5 000	6 700
	80.035	24.608	23.698	18.512	67.0	82.5	6 850	8 400	4 800	6 400
	82.550	29.370	28.575	23.020	87.0	117	8 850	11 900	4 700	6 200
	82.931	23.812	25.400	19.050	76.0	98.0	7 750	10 000	4 500	6 000
	85.725	30.162	30.162	23.812	105	132	10 700	13 400	4 500	6 000
	87.312	30.162	30.886	23.812	94.0	117	9 600	12 000	4 400	5 900
	88.500	25.400	23.698	17.462	70.5	78.0	7 200	7 950	4 000	5 300
88.500	26.988	29.083	22.225	95.5	107	9 750	10 900	4 600	6 100	
39.688	76.200	23.812	25.654	19.050	73.0	90.5	7 450	9 200	5 100	6 800
	77.534	29.370	30.391	23.812	95.0	112	9 700	11 400	4 800	6 400
	79.375	23.812	25.400	19.050	76.5	97.5	7 800	9 950	4 800	6 400
	80.035	29.370	30.391	23.812	95.0	112	9 700	11 400	4 800	6 400
	80.167	29.370	30.391	23.812	95.0	112	9 700	11 400	4 800	6 400
	88.500	25.400	23.698	17.462	70.5	78.0	7 200	7 950	4 000	5 300
40.000	76.200	20.638	20.940	15.507	55.5	63.0	5 650	6 450	5 000	6 700
	80.000	21.000	22.403	17.826	68.0	75.0	6 950	7 650	4 700	6 300
	85.000	20.638	21.692	17.462	69.5	79.5	7 100	8 100	4 400	5 800
	88.500	26.988	29.083	22.225	95.5	107	9 750	10 900	4 600	6 100
	107.950	36.512	36.957	28.575	141	177	14 400	18 100	3 600	4 800
40.483	82.550	29.370	28.575	23.020	87.0	117	8 850	11 900	4 700	6 200
40.988	67.975	17.500	18.000	13.500	46.0	62.5	4 700	6 400	5 300	7 000
41.275	73.025	16.667	17.462	12.700	46.0	55.5	4 700	5 700	5 000	6 600
	73.431	19.558	19.812	14.732	56.0	69.5	5 700	7 100	5 000	6 600
	73.431	21.430	19.812	16.604	56.0	69.5	5 700	7 100	5 000	6 600
	76.200	18.009	17.384	14.288	42.5	51.5	4 350	5 250	4 900	6 500
	76.200	22.225	23.020	17.462	65.0	80.5	6 600	8 200	4 900	6 500
	76.200	25.400	25.400	20.638	76.5	97.5	7 800	9 950	4 800	6 400
	79.375	23.812	25.400	19.050	76.5	97.5	7 800	9 950	4 800	6 400
	80.000	18.009	17.384	14.288	42.5	51.5	4 350	5 250	4 900	6 500

Note: 1. Chamfer dimensions on the back face of the inner and outer rings of the bearing are larger than maximum values for installation dimensions r_{is} and r_{ias} .
 2. As for the maximum value for inner and outer ring diameters of bearings whose bearing numbers are marked with "+" (inner ring) and "++" (outer ring), the precision class is an integer for class 4 and class 2 bearings only.

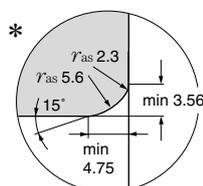
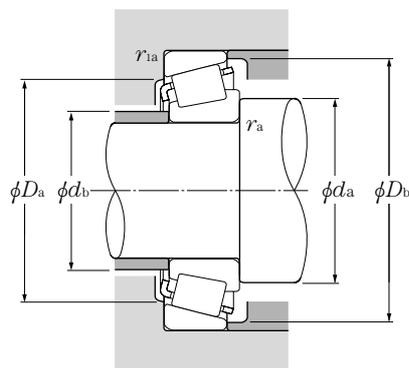

Equivalent radial load

dynamic

$$P_r = XF_r + YF_a$$

$\frac{F_a}{F_r} \leq e$		$\frac{F_a}{F_r} > e$	
X	Y	X	Y
1	0	0.4	Y_2

static

$$P_{or} = 0.5F_r + Y_0F_a$$

When $P_{or} < F_r$ use $P_{or} = F_r$

For values of e , Y_2 and Y_0 see the table below.

Bearing numbers	Abutment and fillet dimensions						Load center mm	Constant	Axial load factors		Mass kg
	mm								a	e	
	d_a	d_b	D_a	D_b	r_{as} max	r_{1as} max					(approx.)
4T-28150/28300	45.5	43.5	68	71	1.5	1.3	4.8	0.40	1.49	0.82	0.405
4T-2776/2720	52	43.5	66	70	4.3	3.3	7.8	0.30	1.98	1.09	0.495
4T-2788/2720	50	43.5	66	70	3.5	3.3	7.8	0.30	1.98	1.09	0.497
4T-26878/26822	45	44.5	71	74	0.8	0.8	7.4	0.32	1.88	1.04	0.574
4T-3490/3420	52	45.5	67	74	3.5	3.3	8.7	0.37	1.64	0.90	0.683
4T-28150/28315	45.5	43.5	69	73	1.5	1.5	4.8	0.40	1.49	0.82	0.467
4T-27880/27820	48	47	68	75	0.8	1.5	2.5	0.56	1.07	0.59	0.562
4T-HM801346/HM801310	51	49	68	78	0.8	3.3	4.7	0.55	1.10	0.60	0.767
4T-25572/25520	46	46	74	77	0.8	0.8	6.2	0.33	1.79	0.99	0.645
4T-3875/3820	49.5	48.5	73	81	0.8	3.3	8.1	0.40	1.49	0.82	0.857
4T-3580/3525	48	45.5	75	81	1.5	3.3	10.0	0.31	1.96	1.08	0.881
4T-44150/44348	55	51	75	84	2.3	1.5	-2.9 ¹⁾	0.78	0.77	0.42	0.711
4T-418/414	51	44.5	77	80	3.5	1.5	9.1	0.26	2.28	1.25	0.84
4T-2789/2720	52	45	66	70	3.5	3.3	7.8	0.30	1.98	1.09	0.477
4T-3382/3321	52	45.5	68	75	3.5	3.3	11.2	0.27	2.20	1.21	0.669
4T-26880/26822	48	45.5	71	74	1.5	0.8	7.4	0.32	1.88	1.04	0.554
4T-3382/3339	52	45.5	71	75	3.5	1.5	11.2	0.27	2.20	1.21	0.666
4T-3386/3320	46.5	45.5	70	75	0.8	3.3	11.2	0.27	2.20	1.21	0.668
4T-44158/44348	58	51	75	84	3.5	1.5	-2.9 ¹⁾	0.78	0.77	0.42	0.691
4T-28158/28300	47.5	45	68	71	1.5	1.3	4.8	0.40	1.49	0.82	0.386
4T-344/332	52	45.5	73	75	3.5	1.3	6.6	0.27	2.20	1.21	0.479
4T-350A/354A	47.5	46.5	77	80	0.8	1.3	5.1	0.31	1.96	1.08	0.562
4T-420/414	52	46	77	80	3.5	1.5	9.1	0.26	2.28	1.25	0.813
4T-543/532X	57	50	94	100	3.5	3.3	12.3	0.30	2.02	1.11	1.77
4T-HM801349/HM801310	58	49	68	78	3.5	3.3	4.7	0.55	1.10	0.60	0.731
4T-LM300849†/LM300811††	52	45	61	65	*	1.5	3.6	0.35	1.72	0.95	0.239
4T-18590/18520	53	46	66	69	3.5	1.5	2.9	0.35	1.71	0.94	0.281
4T-LM501349/LM501310	53	46.5	67	70	3.5	0.8	3.3	0.40	1.50	0.83	0.335
4T-LM501349/LM501314	53	46.5	66	70	3.5	0.8	3.3	0.40	1.50	0.83	0.355
4T-11162/11300	49	46.5	67	71	1.5	1.5	0.7	0.49	1.23	0.68	0.337
4T-24780/24720	54	47	68	72	3.5	0.8	4.5	0.39	1.53	0.84	0.432
4T-26882/26823	54	47	69	73	3.5	1.5	7.4	0.32	1.88	1.04	0.488
4T-26885/26822	48	47	71	74	0.8	0.8	7.4	0.32	1.88	1.04	0.535
4T-11162/11315	49	46.5	69	73	1.5	1.5	0.7	0.49	1.23	0.68	0.389

Note: 3. Chamfer dimensions of bearings marked " * " are shown in drawings.

1) " - " means that load center at outside on end of inner ring.

Inch series

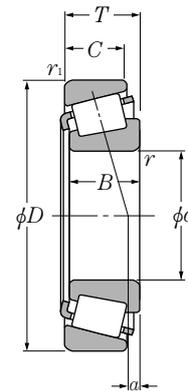

d 41.275 ~ 44.450mm

d	Boundary dimensions				dynamic kN	Basic load ratings		dynamic kgf	static kgf	Limiting speeds	
	D	T	B	C		C _r	C _{or}			grease	oil
41.275	80.000	21.000	22.403	17.826	68.0	75.0	6 950	7 650	4 700	6 300	
	80.000	23.812	25.400	19.050	76.5	97.5	7 800	9 950	4 800	6 400	
	82.550	26.543	25.654	20.193	80.5	104	8 200	10 600	4 600	6 100	
	85.725	30.162	30.162	23.812	105	132	10 700	13 400	4 500	6 000	
	87.312	30.162	30.886	23.812	94.0	117	9 600	12 000	4 400	5 900	
	88.900	30.162	29.370	23.020	93.5	125	9 550	12 700	4 300	5 800	
	90.488	39.688	40.386	33.338	136	175	13 900	17 900	4 300	5 800	
	92.075	26.195	23.812	16.670	72.5	81.5	7 400	8 300	3 800	5 000	
	93.662	31.750	31.750	26.195	104	131	10 600	13 400	4 100	5 500	
	95.250	30.162	29.370	23.020	109	147	11 100	15 000	4 000	5 300	
95.250	30.958	28.300	20.638	82.5	92.0	8 400	9 350	3 700	5 000		
95.250	30.958	28.575	22.225	96.0	116	9 800	11 800	3 700	4 900		
42.070	90.488	39.688	40.386	33.338	136	175	13 900	17 900	4 300	5 800	
42.862	82.550	26.195	26.988	20.638	75.5	97.0	7 700	9 900	4 600	6 100	
	82.931	23.812	25.400	19.050	76.0	98.0	7 750	10 000	4 500	6 000	
	87.312	30.162	30.886	23.812	94.0	117	9 600	12 000	4 400	5 900	
42.875	79.375	23.812	25.400	19.050	76.5	97.5	7 800	9 950	4 800	6 400	
	82.931	23.812	25.400	19.050	76.0	98.0	7 750	10 000	4 500	6 000	
44.450	76.992	17.462	17.145	11.908	44.0	54.0	4 450	5 550	4 700	6 300	
	79.375	17.462	17.462	13.495	45.5	56.0	4 600	5 700	4 600	6 200	
	82.931	23.812	25.400	19.050	76.0	98.0	7 750	10 000	4 500	6 000	
	82.931	23.812	25.400	19.050	76.0	98.0	7 750	10 000	4 500	6 000	
	84.138	30.162	30.886	23.812	94.0	117	9 600	12 000	4 400	5 900	
	85.000	20.638	21.692	17.462	69.5	79.5	7 100	8 100	4 400	5 800	
	87.312	30.162	30.886	23.812	94.0	117	9 600	12 000	4 400	5 900	
	88.900	30.162	29.370	23.020	93.5	125	9 550	12 700	4 300	5 800	
	93.264	30.162	30.302	23.812	102	134	10 400	13 700	4 000	5 300	
	93.662	31.750	31.750	26.195	103	131	10 600	13 400	4 100	5 500	
	95.250	27.783	28.575	22.225	107	139	10 900	14 200	3 900	5 200	
	95.250	27.783	29.900	22.225	108	129	11 000	13 200	4 200	5 600	
	95.250	30.162	29.370	23.020	109	147	11 100	15 000	4 000	5 300	
	95.250	30.958	28.300	20.638	82.5	92.0	8 400	9 350	3 700	5 000	
	95.250	30.958	28.575	22.225	96.0	116	9 800	11 800	3 700	4 900	
101.600	34.925	36.068	26.988	135	165	13 800	16 800	3 800	5 000		
104.775	30.162	29.317	24.605	115	148	11 700	15 000	3 500	4 700		

Note: 1. Chamfer dimensions on the back face of the inner and outer rings of the bearing are larger than maximum values for installation dimensions r_{as} and r_{1as} .

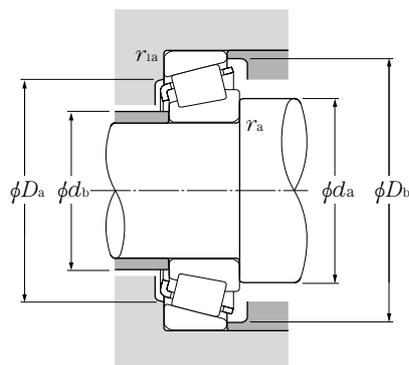

Equivalent radial load dynamic

$$P_r = XF_r + YF_a$$

$\frac{F_a}{F_r} \leq e$		$\frac{F_a}{F_r} > e$	
X	Y	X	Y
1	0	0.4	Y_2

static

$$P_{or} = 0.5F_r + Y_0F_a$$

When $P_{or} < F_r$ use $P_{or} = F_r$

For values of e , Y_2 and Y_0 see the table below.

Bearing numbers	Abutment and fillet dimensions						Load center mm	Constant e	Axial load factors		Mass kg (approx.)
	mm								a	e	
	d_a	d_b	D_a	D_b	r_{as} max	r_{1as} max					
4T-336/332	47	46	73	75	0.8	1.3	6.6	0.27	2.20	1.21	0.468
4T-26882/26824	54	47	70	74	3.5	1.3	7.4	0.32	1.88	1.04	0.542
4T-M802048/M802011	57	51	70	79	3.5	3.3	3.2	0.55	1.10	0.60	0.642
4T-3880/3820	52	50	73	81	0.8	3.3	8.1	0.40	1.49	0.82	0.81
4T-3576/3525	49	48	75	81	0.8	3.3	10.0	0.31	1.96	1.08	0.834
4T-HM803145/HM803110	54	53	74	85	0.8	3.3	4.6	0.55	1.10	0.60	0.901
4T-4388/4335	57	51	77	85	3.5	3.3	15.0	0.28	2.11	1.16	1.25
4T-M903345/M903310	60	54	78	88	3.5	1.5	-3.6 ¹⁾	0.83	0.72	0.40	0.758
4T-46162/46368	52	51	79	87	0.8	3.3	7.1	0.40	1.49	0.82	1.09
4T-HM804840/HM804810	61	54	81	91	3.5	3.3	3.7	0.55	1.10	0.60	1.08
4T-53162/53375	57	53	81	89	1.5	0.8	0.5	0.74	0.81	0.45	0.975
4T-HM903245/HM903210	63	54	81	91	3.5	0.8	-0.4 ¹⁾	0.74	0.81	0.45	1.05
4T-4395/4335	58	51	77	85	3.5	3.3	15.0	0.28	2.11	1.16	1.24
4T-22780/22720	56	50	71	77	3.5	3.3	6.4	0.40	1.49	0.82	0.617
4T-25578/25520	53	49.5	74	77	2.3	0.8	6.2	0.33	1.79	0.99	0.584
4T-3579/3525	56	49.5	75	81	3.5	3.3	10.0	0.31	1.96	1.08	0.805
4T-26884/26822	55	48.5	71	74	3.5	0.8	7.4	0.32	1.88	1.04	0.51
4T-25577/25520	55	49	74	77	3.5	0.8	6.2	0.33	1.79	0.99	0.581
4T-12175/12303	52	49.5	68	73	1.5	1.5	-0.2 ¹⁾	0.51	1.19	0.65	0.308
4T-18685/18620	54	49.5	71	74	2.8	1.5	2.2	0.37	1.60	0.88	0.345
4T-25580/25520	57	50	74	77	3.5	0.8	6.2	0.33	1.79	0.99	0.56
4T-25582/25520	60	50	74	77	5	0.8	6.2	0.33	1.79	0.99	0.556
4T-3578/3520	57	51	74	80	3.5	3.3	10.0	0.31	1.96	1.08	0.699
4T-355/354A	54	50	77	80	2.3	1.3	5.1	0.31	1.96	1.08	0.511
4T-3578/3525	57	51	75	81	3.5	3.3	10.0	0.31	1.96	1.08	0.779
4T-HM803149/HM803110	62	53	74	85	3.5	3.3	4.6	0.55	1.10	0.60	0.849
4T-3782/3720	58	52	82	88	3.5	3.3	8.3	0.34	1.77	0.97	0.961
4T-46175/46368	55	54	79	87	0.8	3.3	7.1	0.40	1.49	0.82	1.04
4T-33885/33821	53	53	85	90	0.8	2.3	8.0	0.33	1.82	1.00	0.987
4T-438/432	57	51	83	87	3.5	2.3	9.2	0.28	2.11	1.16	0.953
4T-HM804842/HM804810	57	57	81	91	0.8	3.3	3.7	0.55	1.10	0.60	1.04
4T-53177/53375	63	53	81	89	3.5	0.8	0.5	0.74	0.81	0.45	0.925
4T-HM903249/HM903210	65	54	81	91	3.5	0.8	-0.4 ¹⁾	0.74	0.81	0.45	1
4T-527/522	59	53	89	95	3.5	3.3	12.9	0.29	2.10	1.16	1.37
4T-460/453X	60	54	92	98	3.5	3.3	7.1	0.34	1.79	0.98	1.29

1) " - " means that load center at outside on end of inner ring.

Inch series

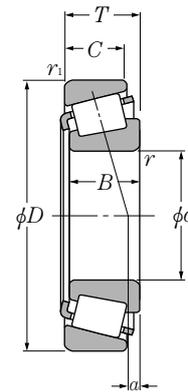

d 44.450 ~ 47.625mm

d	Boundary dimensions				dynamic kN	Basic load ratings		dynamic kgf	static kgf	Limiting speeds	
	D	T	B	C		C _r	C _{or}			grease	oil
44.450	104.775	30.162	30.958	23.812	130	169	13 200	17 300	3 500	4 700	
	104.775	36.512	36.512	28.575	138	189	14 000	19 300	3 600	4 800	
	111.125	30.162	26.909	20.638	104	136	10 600	13 900	3 200	4 200	
	111.125	30.162	26.909	20.638	104	136	10 600	13 900	3 200	4 200	
	127.000	50.800	52.388	41.275	250	320	25 500	33 000	3 200	4 300	
44.983	82.931	23.812	25.400	19.050	76.0	98.0	7 750	10 000	4 500	6 000	
	93.264	30.162	30.302	23.812	102	134	10 400	13 700	4 000	5 300	
45.000	85.000	20.638	21.692	17.462	69.5	79.5	7 100	8 100	4 400	5 800	
	88.900	20.638	22.225	16.513	76.5	90.5	7 800	9 250	4 100	5 500	
45.237	87.312	30.162	30.886	23.812	94.0	117	9 600	12 000	4 400	5 900	
45.242	73.431	19.558	19.812	15.748	54.0	76.0	5 550	7 750	4 800	6 400	
	77.788	19.842	19.842	15.080	57.5	73.5	5 850	7 500	4 600	6 200	
45.618	82.550	23.812	25.400	19.050	76.0	98.0	7 750	10 000	4 500	6 000	
	82.931	23.812	25.400	19.050	76.0	98.0	7 750	10 000	4 500	6 000	
	83.058	23.876	25.400	19.114	76.0	98.0	7 750	10 000	4 500	6 000	
	85.000	23.812	25.400	19.050	76.0	98.0	7 750	10 000	4 500	6 000	
45.987	74.976	18.000	18.000	14.000	51.0	71.0	5 200	7 250	4 700	6 300	
46.038	79.375	17.462	17.462	13.495	45.5	56.0	4 600	5 700	4 600	6 200	
	82.931	23.812	25.400	19.050	76.0	98.0	7 750	10 000	4 500	6 000	
	85.000	20.638	21.692	17.462	69.5	79.5	7 100	8 100	4 400	5 800	
	85.000	25.400	25.608	20.638	79.0	104	8 050	10 600	4 400	5 800	
	90.119	23.000	21.692	21.808	69.5	79.5	7 100	8 100	4 400	5 800	
	93.264	30.162	30.302	23.812	102	134	10 400	13 700	4 000	5 300	
47.625	95.250	27.783	29.900	22.225	108	129	11 000	13 200	4 200	5 600	
	88.900	20.638	22.225	16.513	76.5	90.5	7 800	9 250	4 100	5 500	
	88.900	25.400	25.400	19.050	82.0	101	8 350	10 300	4 200	5 600	
	93.264	30.162	30.302	23.812	102	134	10 400	13 700	4 000	5 300	
	95.250	30.162	29.370	23.020	109	147	11 100	15 000	4 000	5 300	
	96.838	21.000	21.946	15.875	78.0	96.5	7 950	9 850	3 700	5 000	
	101.600	34.925	36.068	26.988	135	165	13 800	16 800	3 800	5 000	
104.775	30.162	29.317	24.605	115	148	11 700	15 000	3 500	4 700		

Note: 1. Chamfer dimensions on the back face of the inner and outer rings of the bearing are larger than maximum values for installation dimensions r_{is} and r_{ios} .
 2. As for the maximum value for inner and outer ring diameters of bearings whose bearing numbers are marked with "+" (inner ring) and "++" (outer ring), the precision class is an integer for class 4 and class 2 bearings only.

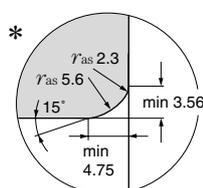
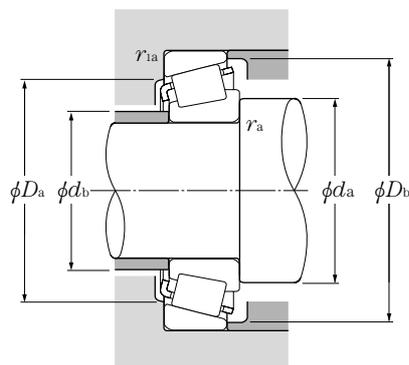

Equivalent radial load dynamic

$$P_r = XF_r + YF_a$$

$\frac{F_a}{F_r} \leq e$		$\frac{F_a}{F_r} > e$	
X	Y	X	Y
1	0	0.4	Y_2

static

$$P_{or} = 0.5F_r + Y_0F_a$$

When $P_{or} < F_r$ use $P_{or} = F_r$

For values of e , Y_2 and Y_0 see the table below.

Bearing numbers	Abutment and fillet dimensions						Load center mm	Constant e	Axial load factors		Mass kg (approx.)
	d_a	d_b	D_a	D_b	r_{as} max	r_{1as} max			Y_2	Y_0	
4T-45280/45220	55	54	93	99	0.8	3.3	7.9	0.33	1.80	0.99	1.35
4T-HM807040/HM807010	66	59	89	100	3.5	3.3	7.4	0.49	1.23	0.68	1.62
4T-55175C/55437	70	64	92	105	3.5	3.3	-7.4 ¹⁾	0.88	0.68	0.37	1.45
4T-55176C/55437	65	65	92	105	0.8	3.3	-7.4 ¹⁾	0.88	0.68	0.37	1.09
4T-6277/6220	67	60	108	117	3.5	3.3	19.5	0.30	2.01	1.11	3.58
4T-25584/25520	53	51	74	77	1.5	0.8	6.2	0.33	1.79	0.99	0.555
4T-3776/3720	59	53	82	88	3.5	3.3	8.3	0.34	1.77	0.97	0.952
4T-358/354A	53	50	77	80	1.5	1.3	5.1	0.31	1.96	1.08	0.505
4T-367/362A	55	51	81	84	2	1.3	4.0	0.32	1.88	1.03	0.595
4T-3586/3525	58	52	75	81	3.5	3.3	10.0	0.31	1.96	1.08	0.765
4T-LM102949/LM102910	56	50	68	70	3.5	0.8	4.7	0.31	1.97	1.08	0.307
4T-LM603049/LM603011	57	50	71	74	3.5	0.8	2.2	0.43	1.41	0.77	0.372
4T-25590/25519	58	51	73	77	3.5	2	6.2	0.33	1.79	0.99	0.534
4T-25590/25520	58	51	74	77	3.5	0.8	6.2	0.33	1.79	0.99	0.543
4T-25590/25522	58	51	73	77	3.5	2	6.2	0.33	1.79	0.99	0.545
4T-25590/25526	58	51	74	78	3.5	2.3	6.2	0.33	1.79	0.99	0.581
4T-LM503349A†/LM503310††	57	51	67	71	*	1.5	1.9	0.40	1.49	0.82	0.296
4T-18690/18620	56	51	71	74	2.8	1.5	2.2	0.37	1.60	0.88	0.329
4T-25592/25520	58	52	74	77	3.5	0.8	6.2	0.33	1.79	0.99	0.538
4T-359A/354A	57	51	77	80	3.5	1.3	5.1	0.31	1.96	1.08	0.489
4T-2984/2924	58	52	76	80	3.5	1.3	6.4	0.35	1.73	0.95	0.615
4T-359S/352	55	51	78	82	2.3	2.3	5.1	0.31	1.96	1.08	0.651
4T-3777/3720	60	53	82	88	3.5	3.3	8.3	0.34	1.77	0.97	0.934
4T-436/432	59	52	83	87	3.5	2.3	9.2	0.28	2.11	1.16	0.927
4T-369A/362A	60	53	81	84	3.5	1.3	4.0	0.32	1.88	1.03	0.559
4T-M804048/M804010	57	56	77	85	0.8	3.3	1.7	0.55	1.10	0.60	0.662
4T-3778/3720	67	55	82	88	6.4	3.3	8.3	0.34	1.77	0.97	0.898
4T-HM804846/HM804810	66	57	81	91	3.5	3.3	3.7	0.55	1.10	0.60	0.978
4T-386A/382A	56	55	89	92	0.8	0.8	3.1	0.35	1.69	0.93	0.72
4T-528/522	62	55	89	95	3.5	3.3	12.9	0.29	2.10	1.16	1.3
4T-463/453X	65	56	92	98	4.8	3.3	7.1	0.34	1.79	0.98	1.24

Note: 3. Chamfer dimensions of bearings marked " * " are shown in drawings.

1) " - " means that load center at outside on end of inner ring.

Tapered Roller Bearings

Inch series
J series

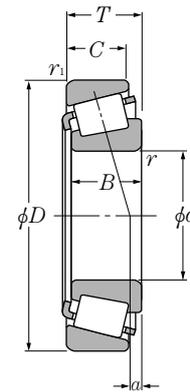

d 47.625 ~ 50.800mm

d	Boundary dimensions				dynamic kN	Basic load ratings			Limiting speeds	
	D	T	B	C		static	dynamic	static	grease	oil
	mm						kgf		min ⁻¹	
					C _r	C _{or}	C _r	C _{or}		
47.625	104.775	30.162	30.958	23.812	130	169	13 200	17 300	3 500	4 700
	111.125	30.162	26.909	20.638	104	136	10 600	13 900	3 200	4 200
	123.825	36.512	32.791	25.400	154	188	15 700	19 200	2 900	3 900
48.412	95.250	30.162	29.370	23.020	109	147	11 100	15 000	4 000	5 300
	95.250	30.162	29.370	23.020	109	147	11 100	15 000	4 000	5 300
49.212	93.264	30.162	30.302	23.812	102	134	10 400	13 700	4 000	5 300
	103.188	43.658	44.475	36.512	174	232	17 700	23 600	3 800	5 000
	104.775	36.512	36.512	28.575	138	189	14 000	19 300	3 600	4 800
	114.300	44.450	44.450	34.925	186	225	19 000	23 000	3 600	4 800
	114.300	44.450	44.450	36.068	203	261	20 700	26 600	3 500	4 700
49.987	82.550	21.590	22.225	16.510	69.5	94.0	7 100	9 600	4 300	5 700
	92.075	24.608	25.400	19.845	83.5	116	8 550	11 800	4 000	5 300
	114.300	44.450	44.450	36.068	203	261	20 700	26 600	3 500	4 700
50.000	82.000	21.500	21.500	17.000	69.5	94.0	7 100	9 600	4 300	5 700
	84.000	22.000	22.000	17.500	69.5	94.5	7 100	9 600	4 300	5 700
	88.900	20.638	22.225	16.513	76.5	90.5	7 800	9 250	4 100	5 500
	88.900	20.638	22.225	16.513	76.5	90.5	7 800	9 250	4 100	5 500
	90.000	28.000	28.000	23.000	106	141	10 800	14 400	4 100	5 400
	105.000	37.000	36.000	29.000	138	189	14 000	19 300	3 600	4 800
	110.000	22.000	21.996	18.824	89.5	120	9 150	12 300	3 200	4 300
50.800	82.550	21.590	22.225	16.510	69.5	94.0	7 100	9 600	4 300	5 700
	85.000	17.462	17.462	13.495	49.5	65.0	5 050	6 600	4 200	5 600
	88.900	17.462	17.462	13.495	49.5	65.0	5 050	6 600	4 200	5 600
	88.900	20.638	22.225	16.513	76.5	90.5	7 800	9 250	4 100	5 500
	88.900	20.638	22.225	16.513	76.5	90.5	7 800	9 250	4 100	5 500
	90.000	20.000	22.225	15.875	76.5	90.5	7 800	9 250	4 100	5 500
	92.075	24.608	25.400	19.845	83.5	116	8 550	11 800	4 000	5 300
	93.264	30.162	30.302	23.812	102	134	10 400	13 700	4 000	5 300
	93.264	30.162	30.302	23.812	102	134	10 400	13 700	4 000	5 300
	95.250	27.783	28.575	22.225	107	139	10 900	14 200	3 900	5 200
	95.250	30.162	30.302	23.812	102	134	10 400	13 700	4 000	5 300
	96.838	21.000	21.946	15.875	78.0	96.5	7 950	9 850	3 700	5 000
	97.630	24.608	24.608	19.446	88.5	128	9 000	13 000	3 700	4 900
	98.425	30.162	30.302	23.812	102	134	10 400	13 700	4 000	5 300

Note: 1. Chamfer dimensions on the back face of the inner and outer rings of the bearing are larger than maximum values for installation dimensions r_{1as} and r_{1as} .
 2. As for the maximum value for inner ring bore diameters of bearings whose bearing numbers are marked with "†" (inner ring), the precision class is an integer for class 4 and class 2 bearings only.

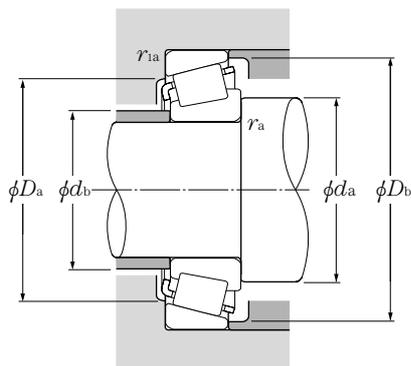

Equivalent radial load dynamic

$$P_r = XF_r + YF_a$$

$\frac{F_a}{F_r} \leq e$		$\frac{F_a}{F_r} > e$	
X	Y	X	Y
1	0	0.4	Y_2

static

$$P_{or} = 0.5F_r + Y_o F_a$$

When $P_{or} < F_r$ use $P_{or} = F_r$

For values of e , Y_2 and Y_o see the table below.

Bearing numbers	Abutment and fillet dimensions						Load center mm	Constant	Axial load factors		Mass kg
	mm								a	e	
	d_a	d_b	D_a	D_b	r_{as} max	r_{1as} max					(approx.)
4T-45282/45220	63	57	93	99	3.5	3.3	7.9	0.33	1.80	0.99	1.29
4T-55187C/55437	69	62	92	105	3.5	3.3	-7.4 ¹⁾	0.88	0.68	0.37	1.4
4T-72188C/72487	69	67	102	116	0.8	3.3	-1.5 ¹⁾	0.74	0.81	0.45	2.16
4T-HM804848/HM804810	63	57	81	91	2.3	3.3	3.7	0.55	1.10	0.60	0.967
4T-HM804849/HM804810	66	57	81	91	3.5	3.3	3.7	0.55	1.10	0.60	0.964
4T-3781/3720	62	56	82	88	3.5	3.3	8.3	0.34	1.77	0.97	0.877
4T-5395/5335	66	60	89	97	3.5	3.3	16.1	0.30	2.02	1.11	1.75
4T-HM807044/HM807010	69	63	89	100	3.5	3.3	7.4	0.49	1.23	0.68	1.52
4T-65390/65320	70	60	97	107	3.5	3.3	12.5	0.43	1.39	0.77	2.23
4T-HH506348/HH506310	71	61	97	107	3.5	3.3	13.3	0.40	1.49	0.82	2.33
4T-LM104947A†/LM104911	55	55	75	78	0.5	1.3	5.8	0.31	1.97	1.08	0.434
4T-28579†/28521	60	56	83	87	2.3	0.8	4.6	0.38	1.59	0.87	0.718
4T-HH506349†/HH506310	72	61	97	107	3.5	3.3	13.3	0.40	1.49	0.82	2.27
# 4T-JLM104948/JLM104910	60	55	76	78	3	0.5	5.4	0.31	1.97	1.08	0.42
# 4T-JLM704649/JLM704610	62	56	76	80	3.5	1.5	2.3	0.44	1.37	0.75	0.466
4T-365/362A	58	55	81	84	2	1.3	4.0	0.32	1.88	1.03	0.53
4T-366/362A	59	55	81	84	2.3	1.3	4.0	0.32	1.88	1.03	0.529
# 4T-JM205149/JM205110	62	57	80	85	3	2.5	7.4	0.33	1.82	1.00	0.752
# 4T-JHM807045/JHM807012	69	63	90	100	3	2.5	7.5	0.49	1.23	0.68	1.52
4T-396/394A	61	60	101	104	0.8	1.3	0.7	0.40	1.49	0.82	1.06
4T-LM104949/LM104911	62	55	75	78	3.5	1.3	5.8	0.31	1.97	1.08	0.419
4T-18790/18720	62	56	77	80	3.5	1.5	0.8	0.41	1.48	0.81	0.374
4T-18790/18724	62	56	78	82	3.5	1.3	0.8	0.41	1.48	0.81	0.431
4T-368/362A	58	56	81	84	1.5	1.3	4.0	0.32	1.88	1.03	0.519
4T-370A/362A	65	56	81	84	5	1.3	4.0	0.32	1.88	1.03	0.511
4T-368A/362	62	56	81	84	3.5	2	4.0	0.32	1.88	1.03	0.525
4T-28580/28521	63	57	83	87	3.5	0.8	4.6	0.38	1.59	0.87	0.703
4T-3775/3720	58	58	82	88	0.8	3.3	8.3	0.34	1.77	0.97	0.852
4T-3780/3720	64	58	82	88	3.5	3.3	8.3	0.34	1.77	0.97	0.848
4T-33889/33821	64	58	85	90	3.5	2.3	8.0	0.33	1.82	1.00	0.876
4T-3780/3726	64	58	83	89	3.5	3.3	8.3	0.34	1.77	0.97	0.903
4T-385A/382A	61	60	89	92	2.3	0.8	3.1	0.35	1.69	0.93	0.676
4T-28678/28622	65	58	88	92	3.5	0.8	3.3	0.40	1.49	0.82	0.852
4T-3780/3732	64	58	84	90	3.5	3.3	8.3	0.34	1.77	0.97	0.993

Note: 3. Bearing numbers marked " # " designate J-series bearings. The tolerances of these bearings is listed in Table 6.6 on page A-42.

1) " - " means that load center at outside on end of inner ring.

Inch series
J series

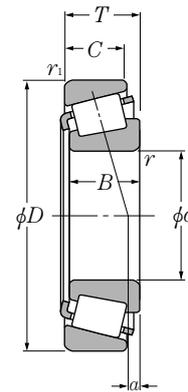

d 50.800 ~ 55.000mm

d	Boundary dimensions				dynamic kN	Basic load ratings			Limiting speeds	
	D	T	B	C		static	dynamic	static	grease	oil
	mm						kgf		min ⁻¹	
					C _r	C _{or}	C _r	C _{or}		
50.800	101.600	31.750	31.750	25.400	110	136	11 200	13 900	3 700	5 000
	101.600	34.925	36.068	26.988	135	165	13 800	16 800	3 800	5 000
	104.775	30.162	29.317	24.605	115	148	11 700	15 000	3 500	4 700
	104.775	30.162	30.958	23.812	130	169	13 200	17 300	3 500	4 700
	104.775	36.512	36.512	28.575	138	189	14 000	19 300	3 600	4 800
	104.775	36.512	36.512	28.575	143	178	14 500	18 100	3 700	4 900
	107.950	36.512	36.957	28.575	141	177	14 400	18 100	3 600	4 800
	111.125	30.162	28.575	20.638	104	136	10 600	13 900	3 200	4 200
	112.712	30.162	26.909	20.638	104	136	10 600	13 900	3 200	4 200
	112.712	30.162	30.048	23.812	119	174	12 200	17 800	3 200	4 300
	112.712	30.162	30.162	23.812	138	195	14 100	19 800	3 200	4 200
	117.475	33.338	31.750	23.812	130	153	13 200	15 600	3 300	4 400
	120.650	41.275	41.275	31.750	172	213	17 500	21 700	3 300	4 400
	123.825	36.512	32.791	25.400	154	188	15 700	19 200	2 900	3 900
123.825	38.100	36.678	30.162	158	216	16 100	22 000	3 000	4 100	
51.592	88.900	20.638	22.225	16.513	76.5	90.5	7 800	9 250	4 100	5 500
52.388	92.075	24.608	25.400	19.845	83.5	116	8 550	11 800	4 000	5 300
	93.264	30.162	30.302	23.812	102	134	10 400	13 700	4 000	5 300
	95.250	27.783	28.575	22.225	107	139	10 900	14 200	3 900	5 200
53.975	88.900	19.050	19.050	13.492	61.0	82.5	6 200	8 450	4 000	5 300
	95.250	27.783	28.575	22.225	107	139	10 900	14 200	3 900	5 200
	96.838	21.000	21.946	15.875	78.0	96.5	7 950	9 850	3 700	5 000
	104.775	30.162	30.958	23.812	130	169	13 200	17 300	3 500	4 700
	104.775	36.512	36.512	28.575	138	189	14 000	19 300	3 600	4 800
	107.950	36.512	36.957	28.575	141	177	14 400	18 100	3 600	4 800
	120.650	41.275	41.275	31.750	172	213	17 500	21 700	3 300	4 400
	122.238	33.338	31.750	23.812	134	163	13 700	16 600	3 100	4 200
	122.238	43.658	43.764	36.512	194	283	19 700	28 900	3 100	4 100
	123.825	36.512	32.791	25.400	154	188	15 700	19 200	2 900	3 900
	123.825	38.100	36.678	30.162	158	216	16 100	22 000	3 000	4 100
130.175	36.512	33.338	23.812	156	186	15 900	19 000	2 700	3 600	
140.030	36.512	33.236	23.520	171	212	17 400	21 600	2 600	3 400	
54.488	104.775	36.512	36.512	28.575	138	189	14 000	19 300	3 600	4 800
55.000	90.000	23.000	23.000	18.500	77.5	109	7 900	11 100	3 900	5 300

Note: 1. With regard to the chamfer dimensions on the back face of the inner and outer rings, installation dimensions r_{1is} and r_{1os} are larger than the maximum value.
2. Bearing numbers marked " # " designate J-series bearings. The accuracy of these bearings is listed in Table 6.6 on page A-42.

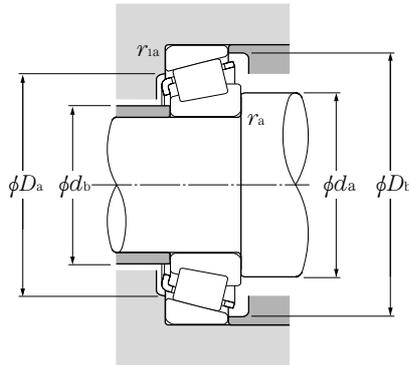

Equivalent radial load dynamic

$$P_r = XF_r + YF_a$$

$\frac{F_a}{F_r} \leq e$		$\frac{F_a}{F_r} > e$	
X	Y	X	Y
1	0	0.4	Y ₂

static

$$P_{or} = 0.5F_r + Y_0F_a$$

When $P_{or} < F_r$ use $P_{or} = F_r$

For values of e , Y_2 and Y_0 see the table below.

Bearing numbers	Abutment and fillet dimensions						Load center mm	Constant e	Axial load factors		Mass kg (approx.)
	mm								a	Y ₂	
	d _a	d _b	D _a	D _b	r _{as} max	r _{1as} max					
4T-49585/49520	66	59	88	96	3.5	3.3	7.1	0.40	1.50	0.82	1.13
4T-529/522	59	58	89	95	0.8	3.3	12.9	0.29	2.10	1.16	1.24
4T-455/453X	60	59	92	98	0.8	3.3	7.1	0.34	1.79	0.98	1.19
4T-45284/45220	71	59	93	99	6.4	3.3	7.9	0.33	1.80	0.99	1.22
4T-HM807046/HM807010	70	63	89	100	3.5	3.3	7.4	0.49	1.23	0.68	1.49
4T-59200/59412	68	61	92	99	3.5	3.3	9.6	0.40	1.49	0.82	1.44
4T-537/532X	65	59	94	100	3.5	3.3	12.3	0.30	2.02	1.11	1.55
4T-HM907643/HM907614	74	65	91	105	3.5	3.3	-7.2 ¹⁾	0.88	0.68	0.37	1.36
4T-55200C/55443	71	65	92	106	3.5	3.3	-7.4 ¹⁾	0.88	0.68	0.37	1.34
4T-3975/3920	68	61	99	106	3.5	3.3	4.5	0.40	1.49	0.82	1.53
4T-39575/39520	68	61	101	107	3.5	3.3	6.6	0.34	1.77	0.97	1.54
4T-66200/66462	71	65	100	111	3.5	3.3	0.4	0.63	0.96	0.53	1.67
4T-619/612	67	61	105	110	3.5	3.3	14.4	0.31	1.91	1.05	2.3
4T-72200C/72487	77	67	102	116	3.5	3.3	-1.5 ¹⁾	0.74	0.81	0.45	2.1
4T-555/552A	66	62	109	116	2.3	3.3	9.4	0.35	1.73	0.95	2.34
4T-368S/362A	59	56	81	84	2	1.3	4.0	0.32	1.88	1.03	0.507
4T-28584/28521	65	58	83	87	3.5	0.8	4.6	0.38	1.59	0.87	0.677
4T-3767/3720	63	59	82	88	2.3	3.3	8.3	0.34	1.77	0.97	0.819
4T-33890/33821	61	59	85	90	1.5	2.3	8.0	0.33	1.82	1.00	0.851
4T-LM806649/LM806610	63	60	80	85	2.3	2	-2.2 ¹⁾	0.55	1.10	0.60	0.437
4T-33895/33822	63	60	86	90	1.5	0.8	8.0	0.33	1.82	1.00	0.824
4T-389A/382A	61	60	89	92	0.8	0.8	3.1	0.35	1.69	0.93	0.633
4T-45287/45220	62	62	93	99	0.8	3.3	7.9	0.33	1.80	0.99	1.17
4T-HM807049/HM807010	73	63	89	100	3.5	3.3	7.4	0.49	1.23	0.68	1.41
4T-539/532X	68	61	94	100	3.5	3.3	12.3	0.30	2.02	1.11	1.47
4T-621/612	70	63	105	110	3.5	3.3	14.4	0.31	1.91	1.05	2.21
4T-66584/66520	75	68	105	116	3.5	3.3	-1.8 ¹⁾	0.67	0.90	0.50	1.79
4T-5578/5535	73	67	106	116	3.5	3.3	13.3	0.36	1.67	0.92	2.64
4T-72212C/72487	79	67	102	116	3.5	3.3	-1.5 ¹⁾	0.74	0.81	0.45	2.03
4T-557S/552A	71	65	109	116	3.5	3.3	9.4	0.35	1.73	0.95	2.26
4T-HM911242/HM911210	79	74	109	124	3.5	3.3	-5.2 ¹⁾	0.82	0.73	0.40	2.27
4T-78214C/78551	79	77	117	132	0.8	2.3	-8.5 ¹⁾	0.87	0.69	0.38	2.77
4T-HM807048/HM807010	73	63	89	100	3.5	3.3	7.4	0.49	1.23	0.68	1.40
# 4T-JLM506849/JLM506810	63	61	82	86	1.5	0.5	2.8	0.40	1.49	0.82	0.558

1) " - " means that load center at outside on end of inner ring.

Inch series
J series

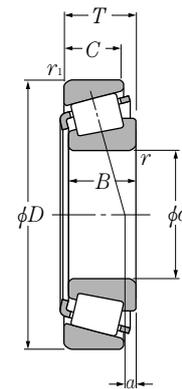

d 55.000 ~ 60.000mm

d	Boundary dimensions				dynamic kN	Basic load ratings			Limiting speeds	
	D	T	B	C		static	dynamic	static	grease	oil
55.000	95.000	29.000	29.000	23.500	107	144	10 900	14 700	3 800	5 100
	96.838	21.000	21.946	15.875	78.0	96.5	7 950	9 850	3 700	5 000
	110.000	39.000	39.000	32.000	173	219	17 600	22 400	3 500	4 600
55.562	97.630	24.608	24.608	19.446	88.5	128	9 000	13 000	3 700	4 900
	123.825	36.512	32.791	25.400	154	188	15 700	19 200	2 900	3 900
	127.000	36.512	36.512	26.988	163	228	16 600	23 300	2 900	3 800
55.575	96.838	21.000	21.946	15.875	78	96.5	7 950	9 850	3 700	5 000
57.150	96.838	21.000	21.946	15.875	78	96.5	7 950	9 850	3 700	5 000
	96.838	21.000	21.946	15.875	78	96.5	7 950	9 850	3 700	5 000
	96.838	21.000	21.946	15.875	78	96.5	7 950	9 850	3 700	5 000
	96.838	21.000	21.946	15.875	78	96.5	7 950	9 850	3 700	5 000
	97.630	24.608	24.608	19.446	88.5	128	9 000	13 000	3 700	4 900
	104.775	30.162	29.317	24.605	115	148	11 700	15 000	3 500	4 700
	104.775	30.162	29.317	24.605	115	148	11 700	15 000	3 500	4 700
	104.775	30.162	30.958	23.812	130	169	13 200	17 300	3 500	4 700
	107.950	27.783	29.317	22.225	115	148	11 700	15 000	3 500	4 700
	110.000	22.000	21.996	18.824	89.5	120	9 150	12 300	3 200	4 300
	110.000	27.795	29.317	27.000	115	148	11 700	15 000	3 500	4 700
	112.712	30.162	30.048	23.812	119	174	12 200	17 800	3 200	4 300
	112.712	30.162	30.162	23.812	138	195	14 100	19 800	3 200	4 200
	112.712	30.162	30.162	23.812	138	195	14 100	19 800	3 200	4 200
	117.475	30.162	30.162	23.812	117	175	11 900	17 900	3 000	4 000
	117.475	33.338	31.750	23.812	130	153	13 200	15 600	3 300	4 400
	120.650	41.275	41.275	31.750	172	213	17 500	21 700	3 300	4 400
123.825	36.512	32.791	25.400	154	188	15 700	19 200	2 900	3 900	
123.825	38.100	36.678	30.162	158	216	16 100	22 000	3 000	4 100	
140.030	36.512	33.236	23.520	171	212	17 400	21 600	2 600	3 400	
57.531	96.838	21.000	21.946	15.875	78.0	96.5	7 950	9 850	3 700	5 000
59.972	122.238	33.338	31.750	23.812	134	163	13 700	16 600	3 100	4 200
59.987	146.050	41.275	39.688	25.400	199	234	20 300	23 900	2 400	3 200
60.000	95.000	24.000	24.000	19.000	83.0	122	8 500	12 400	3 700	4 900
	107.950	25.400	25.400	19.050	91.5	140	9 350	14 200	3 200	4 300

Note: 1. Chamfer dimensions on the back face of the inner and outer rings of the bearing are larger than maximum values for installation dimensions r_{is} and r_{1is} .
 2. As for the maximum value for inner ring bore diameters of bearings whose bearing numbers are marked with "+" (inner ring), the precision class is an integer for class 4 and class 2 bearings only.

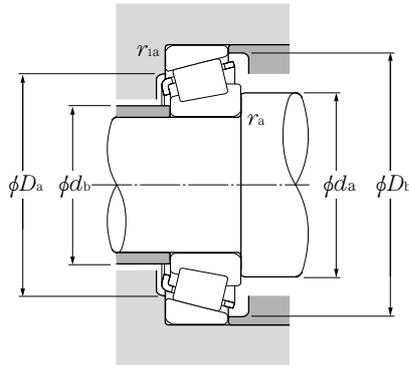

Equivalent radial load dynamic

$$P_r = XF_r + YF_a$$

$\frac{F_a}{F_r} \leq e$		$\frac{F_a}{F_r} > e$	
X	Y	X	Y
1	0	0.4	Y_2

static

$$P_{or} = 0.5F_r + Y_0F_a$$

When $P_{or} < F_r$ use $P_{or} = F_r$

For values of e , Y_2 and Y_0 see the table below.

Bearing numbers	Abutment and fillet dimensions						Load center mm	Constant e	Axial load factors		Mass kg (approx.)
	d_a	d_b	D_a	D_b	r_{as} max	r_{1as} max			Y_2	Y_0	
# 4T-JM207049/JM207010	64	62	85	91	1.5	2.5	7.6	0.33	1.79	0.99	0.82
4T-385/382A	65	61	89	92	2.3	0.8	3.1	0.35	1.69	0.93	0.616
# 4T-JH307749/JH307710	71	64	97	104	3	2.5	11.7	0.35	1.73	0.95	1.71
4T-28680/28622	68	62	88	92	3.5	0.8	3.3	0.40	1.49	0.82	0.774
4T-72218C/72487	80	67	102	116	3.5	3.3	-1.5 ¹⁾	0.74	0.81	0.45	1.99
4T-HM813840/HM813810	76	70	111	121	3.5	3.3	3.7	0.50	1.20	0.66	2.34
4T-389/382A	65	61	89	92	2.3	0.8	3.1	0.35	1.69	0.93	0.608
4T-387/382A	66	62	89	92	2.3	0.8	3.1	0.35	1.69	0.93	0.583
4T-387A/382A	69	62	89	92	3.5	0.8	3.1	0.35	1.69	0.93	0.581
4T-387AS/382A	72	62	89	92	5	0.8	3.1	0.35	1.69	0.93	0.576
4T-387S/382A	63	62	89	92	0.8	0.8	3.1	0.35	1.69	0.93	0.585
4T-28682/28622	70	63	88	92	3.5	0.8	3.3	0.40	1.49	0.82	0.747
4T-462/453X	67	63	92	98	2.3	3.3	7.1	0.34	1.79	0.98	1.06
4T-469/453X	70	63	92	98	3.5	3.3	7.1	0.34	1.79	0.98	1.06
4T-45289/45220	65	65	93	99	0.8	3.3	7.9	0.33	1.80	0.99	1.1
4T-469/453A	70	63	97	100	3.5	0.8	7.1	0.34	1.79	0.98	1.11
4T-390/394A	70	66	101	104	2.3	1.3	0.7	0.40	1.49	0.82	0.954
4T-469/454	70	63	96	100	3.5	2	7.1	0.34	1.79	0.98	1.24
4T-3979/3920	72	66	99	106	3.5	3.3	4.5	0.40	1.49	0.82	1.4
4T-39580/39520	72	66	101	107	3.5	3.3	6.6	0.34	1.77	0.97	1.41
4T-39581/39520	81	66	101	107	8	3.3	6.6	0.34	1.77	0.97	1.4
4T-33225/33462	74	68	104	112	3.5	3.3	2.6	0.44	1.38	0.76	1.58
4T-66225/66462	76	69	100	111	3.5	3.3	0.4	0.63	0.96	0.53	1.54
4T-623/612	72	66	105	110	3.5	3.3	14.4	0.31	1.91	1.05	2.12
4T-72225C/72487	81	67	102	116	3.5	3.3	-1.5 ¹⁾	0.74	0.81	0.45	1.96
4T-555S/552A	73	67	109	116	3.5	3.3	9.4	0.35	1.73	0.95	2.18
4T-78225/78551	83	77	117	132	3.5	2.3	-8.5 ¹⁾	0.87	0.69	0.38	2.69
4T-388A/382A	69	63	89	92	3.5	0.8	3.1	0.35	1.69	0.93	0.575
4T-66589/66520	74	73	105	116	0.8	3.3	-1.8 ¹⁾	0.67	0.90	0.50	1.66
4T-H913840†/H913810	88	82	124	138	3.5	3.3	-4.3 ¹⁾	0.78	0.77	0.42	3.22
# 4T-JLM508748/JLM508710	75	66	85	91	5	2.5	3.0	0.40	1.49	0.82	0.606
4T-29580/29520	75	68	96	103	3.5	3.3	0.6	0.46	1.31	0.72	0.992

Note: 3. Bearing numbers marked " # " designate J-series bearings. The tolerances of these bearings is listed in Table 6.6 on page A-42.

1) " - " means that load center at outside on end of inner ring.

Tapered Roller Bearings

Inch series
J series

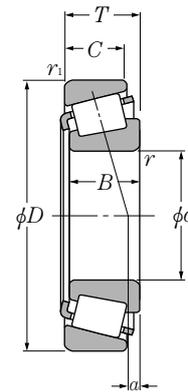

d 60.000 ~ 65.000mm

d	Boundary dimensions				dynamic kN	Basic load ratings			Limiting speeds	
	D	T	B	C		static	dynamic	static	grease	oil
	mm						kgf		min ⁻¹	
					C _r	C _{or}	C _r	C _{or}		
60.000	110.000	22.000	21.996	18.824	89.5	120	9 150	12 300	3 200	4 300
	130.000	34.100	30.924	22.650	156.0	186	15 900	19 000	2 700	3 600
60.325	100.000	25.400	25.400	19.845	90.5	134	9 200	13 600	3 500	4 700
	112.712	30.162	30.048	23.812	119	174	12 200	17 800	3 200	4 300
	122.238	38.100	38.354	29.718	187	244	19 100	24 900	3 100	4 100
	122.238	43.658	43.764	36.512	194	283	19 700	28 900	3 100	4 100
	123.825	38.100	36.678	30.162	158	216	16 100	22 000	3 000	4 100
	127.000	36.512	36.512	26.988	163	228	16 600	23 300	2 900	3 800
	127.000	44.450	44.450	34.925	203	263	20 700	26 800	3 100	4 200
130.175	36.512	33.338	23.812	156	186	15 900	19 000	2 700	3 600	
61.912	110.000	22.000	21.996	18.824	89.5	120	9 150	12 300	3 200	4 300
	136.525	46.038	46.038	36.512	224	355	22 800	36 500	2 600	3 500
	146.050	41.275	39.688	25.400	199	234	20 300	23 900	2 400	3 200
61.976	101.600	24.608	24.608	19.845	90.5	134	9 200	13 600	3 500	4 700
62.738	101.600	25.400	25.400	19.845	90.5	134	9 200	13 600	3 500	4 700
63.500	94.458	19.050	19.050	15.083	60.5	103	6 150	10 500	3 600	4 800
	107.950	25.400	25.400	19.050	91.5	140	9 350	14 200	3 200	4 300
	107.950	25.400	25.400	19.050	91.5	140	9 350	14 200	3 200	4 300
	110.000	22.000	21.996	18.824	89.5	120	9 150	12 300	3 200	4 300
	110.000	25.400	25.400	19.050	91.5	140	9 350	14 200	3 200	4 300
	112.712	30.162	30.048	23.812	119	174	12 200	17 800	3 200	4 300
	112.712	30.162	30.162	23.812	138	195	14 100	19 800	3 200	4 200
	120.000	29.794	29.007	24.237	128	177	13 000	18 100	3 000	4 000
	120.000	29.794	29.007	24.237	128	177	13 000	18 100	3 000	4 000
	122.238	38.100	38.354	29.718	187	244	19 100	24 900	3 100	4 100
	122.238	43.658	43.764	36.512	194	283	19 700	28 900	3 100	4 100
	123.825	38.100	36.678	30.162	158	216	16 100	22 000	3 000	4 100
	127.000	36.512	36.170	28.575	163	229	16 600	23 300	2 900	3 800
	127.000	36.512	36.512	26.988	163	228	16 600	23 300	2 900	3 800
	136.525	41.275	41.275	31.750	194	262	19 800	26 700	2 800	3 800
140.030	36.512	33.236	23.520	171	212	17 400	21 600	2 600	3 400	
65.000	105.000	24.000	23.000	18.500	85.0	117	8 700	11 900	3 300	4 500
	110.000	28.000	28.000	22.500	119	174	12 200	17 800	3 200	4 300

Note: 1. Chamfer dimensions on the back face of the inner and outer rings of the bearing are larger than maximum values for installation dimensions r_{as} and r_{1as} .
2. Bearing numbers marked " # " designate J-series bearings. The accuracy of these bearings is listed in Table 6.6 on page A-42.

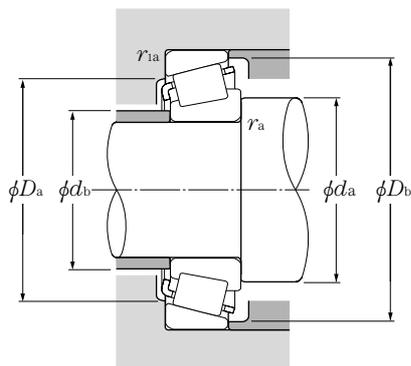

Equivalent radial load dynamic

$$P_r = XF_r + YF_a$$

$\frac{F_a}{F_r} \leq e$		$\frac{F_a}{F_r} > e$	
X	Y	X	Y
1	0	0.4	Y ₂

static

$$P_{or} = 0.5F_r + Y_oF_a$$

When $P_{or} < F_r$ use $P_{or} = F_r$

For values of e , Y_2 and Y_o see the table below.

Bearing numbers	Abutment and fillet dimensions						Load center mm	Constant e	Axial load factors		Mass kg (approx.)
	mm								a	Y ₂	
	d _a	d _b	D _a	D _b	r _{as} max	r _{1as} max					
4T-397/394A	69	68	101	104	0.8	1.3	0.7	0.40	1.49	0.82	0.91
# 4T-JHM911244/JHM911211	84	74	109	123	3.5	3.3	-7.6 ¹⁾	0.82	0.73	0.40	2.01
4T-28985/28921	73	67	89	96	3.5	3.3	2.5	0.43	1.41	0.78	0.772
4T-3980/3920	75	68	99	106	3.5	3.3	4.5	0.40	1.49	0.82	1.33
4T-HM212044/HM212011	85	70	108	116	8	3.3	11.1	0.34	1.78	0.98	2.02
4T-5583/5535	78	72	106	116	3.5	3.3	13.3	0.36	1.67	0.92	2.44
4T-558/552A	73	69	109	116	2.3	3.3	9.4	0.35	1.73	0.95	2.1
4T-HM813841/HM813810	80	73	111	121	3.5	3.3	3.7	0.50	1.20	0.66	2.21
4T-65237/65500	82	71	107	119	3.5	3.3	9.3	0.49	1.23	0.68	2.65
4T-HM911245/HM911210	87	74	109	124	5	3.3	-5.2 ¹⁾	0.82	0.73	0.40	2.12
4T-392/394A	70	69	101	104	0.8	1.3	0.7	0.40	1.49	0.82	0.879
4T-H715334/H715311	86	79	118	132	3.5	3.3	8.7	0.47	1.27	0.70	3.47
4T-H913842/H913810	90	82	124	138	3.5	3.3	-4.3 ¹⁾	0.78	0.77	0.42	3.17
4T-28990/28920	72	68	90	97	2	3.3	1.7	0.43	1.41	0.78	0.768
4T-28995/28920	75	69	90	97	3.5	3.3	2.5	0.43	1.41	0.78	0.764
4T-L610549/L610510	71	69	86	91	1.5	1.5	-0.6 ¹⁾	0.42	1.41	0.78	0.449
4T-29585/29520	77	71	96	103	3.5	3.3	0.6	0.46	1.31	0.72	0.924
4T-29586/29520	73	71	96	103	1.5	3.3	0.6	0.46	1.31	0.72	0.929
4T-390A/394A	73	70	101	104	1.5	1.3	0.7	0.40	1.49	0.82	0.851
4T-29585/29521	77	71	99	104	3.5	1.3	0.6	0.46	1.31	0.72	0.982
4T-3982/3920	77	71	99	106	3.5	3.3	4.5	0.40	1.49	0.82	1.26
4T-39585/39520	77	71	101	107	3.5	3.3	6.6	0.34	1.77	0.97	1.27
4T-477/472	73	72	107	114	0.8	2	3.9	0.38	1.56	0.86	1.49
4T-483/472	78	72	107	114	3.5	2	3.9	0.38	1.56	0.86	1.48
4T-HM212046/HM212011	80	73	108	116	3.5	3.3	11.1	0.34	1.78	0.98	1.95
4T-5584/5535	81	75	106	116	3.5	3.3	13.3	0.36	1.67	0.92	2.34
4T-559/552A	78	72	109	116	3.5	3.3	9.4	0.35	1.73	0.95	2.01
4T-565/563	80	73	112	120	3.5	3.3	8.3	0.36	1.65	0.91	2.11
4T-HM813842/HM813810	82	76	111	121	3.5	3.3	3.7	0.50	1.20	0.66	2.12
4T-639/632	81	74	118	125	3.5	3.3	11.4	0.36	1.66	0.91	2.85
4T-78250/78551	85	79	117	132	2.3	2.3	-8.5 ¹⁾	0.87	0.69	0.38	2.54
# 4T-JLM710949/JLM710910	77	71	96	101	3	1	0.3	0.45	1.32	0.73	0.742
# 4T-JM511946/JM511910	78	72	99	105	3	2.5	3.4	0.40	1.49	0.82	1.08

1) " - " means that load center at outside on end of inner ring.

Tapered Roller Bearings

Inch series
J series

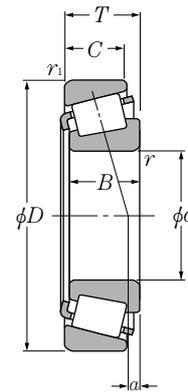

d 65.000 ~ 70.000mm

d	Boundary dimensions				dynamic kN	Basic load ratings			Limiting speeds	
	D	T	B	C		static	dynamic	static	grease	oil
	mm						kgf		min ⁻¹	
					C _r	C _{or}	C _r	C _{or}		
65.000	120.000	39.000	38.500	32.000	185	248	18 800	25 300	3 100	4 100
65.088	135.755	53.975	56.007	44.450	278	380	28 300	38 500	2 900	3 800
66.675	103.213	17.602	17.602	11.989	60.0	78.0	6 100	8 000	3 300	4 400
	107.950	25.400	25.400	19.050	91.5	140	9 350	14 200	3 200	4 300
	110.000	22.000	21.996	18.824	89.5	120	9 150	12 300	3 200	4 300
	112.712	30.162	30.048	23.812	119	174	12 200	17 800	3 200	4 300
	112.712	30.162	30.048	23.812	119	174	12 200	17 800	3 200	4 300
	112.712	30.162	30.162	23.812	138	195	14 100	19 800	3 200	4 200
	122.238	38.100	38.354	29.718	187	244	19 100	24 900	3 100	4 100
	123.825	38.100	36.678	30.162	158	216	16 100	22 000	3 000	4 100
	127.000	36.512	36.512	26.988	163	228	16 600	23 300	2 900	3 800
	130.175	41.275	41.275	31.750	194	262	19 800	26 700	2 800	3 800
	135.755	53.975	56.007	44.450	278	380	28 300	38 500	2 900	3 800
136.525	41.275	41.275	31.750	194	262	19 800	26 700	2 800	3 800	
136.525	41.275	41.275	31.750	226	293	23 100	29 900	2 700	3 700	
68.262	110.000	22.000	21.996	18.824	89.5	120	9 150	12 300	3 200	4 300
	120.000	29.794	29.007	24.237	128	177	13 000	18 100	3 000	4 000
	123.825	38.100	36.678	30.162	158	216	16 100	22 000	3 000	4 100
	136.525	41.275	41.275	31.750	226	293	23 100	29 900	2 700	3 700
	136.525	46.038	46.038	36.512	224	355	22 800	36 500	2 600	3 500
69.850	112.712	25.400	25.400	19.050	95.5	151	9 750	15 400	3 100	4 100
	117.475	30.162	30.162	23.812	117	175	11 900	17 900	3 000	4 000
	120.000	29.794	29.007	24.237	128	177	13 000	18 100	3 000	4 000
	120.000	32.545	32.545	26.195	147	214	15 000	21 800	3 000	4 000
	120.650	25.400	25.400	19.050	95.5	151	9 750	15 400	3 100	4 100
	127.000	36.512	36.170	28.575	163	229	16 600	23 300	2 900	3 800
	136.525	41.275	41.275	31.750	194	262	19 800	26 700	2 800	3 800
	146.050	41.275	41.275	31.750	206	295	21 000	30 000	2 500	3 300
	150.089	44.450	46.672	36.512	261	360	26 600	37 000	2 400	3 200
	168.275	53.975	56.363	41.275	340	460	34 500	46 500	2 200	3 000
69.952	121.442	24.608	23.012	17.462	91.0	127	9 300	13 000	2 900	3 800
70.000	110.000	26.000	25.000	20.500	97.0	150	9 900	15 300	3 200	4 200
	115.000	29.000	29.000	23.000	124	171	12 700	17 500	3 100	4 100

Note: 1. Chamfer dimensions on the back face of the inner and outer rings of the bearing are larger than maximum values for installation dimensions r_{as} and r_{1as} .
2. Bearing numbers marked " # " designate J-series bearings. The accuracy of these bearings is listed in Table 6.6 on page A-42.

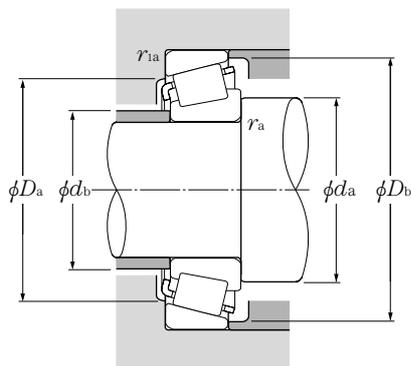

Equivalent radial load dynamic

$$P_r = XF_r + YF_a$$

$\frac{F_a}{F_r} \leq e$		$\frac{F_a}{F_r} > e$	
X	Y	X	Y
1	0	0.4	Y ₂

static

$$P_{or} = 0.5F_r + Y_oF_a$$

When $P_{or} < F_r$ use $P_{or} = F_r$

For values of e , Y_2 and Y_o see the table below.

Bearing numbers	Abutment and fillet dimensions						Load center mm	Constant e	Axial load factors		Mass kg (approx.)
	mm								a	Y ₂	
	d _a	d _b	D _a	D _b	r _{as} max	r _{1as} max					
# 4T-JH211749/JH211710	80	74	107	114	3	2.5	10.9	0.34	1.78	0.98	1.90
4T-6379/6320	84	77	117	126	3.5	3.3	18.8	0.32	1.85	1.02	3.71
4T-L812148/L812111	74	72	96	99	1.5	0.8	-3.7 ¹⁾	0.49	1.23	0.68	0.48
4T-29590/29520	80	73	96	103	3.5	3.3	0.6	0.46	1.31	0.72	0.86
4T-395A/394A	73	73	101	104	0.8	1.3	0.7	0.40	1.49	0.82	0.796
4T-3984/3925	80	74	101	106	3.5	0.8	4.5	0.40	1.49	0.82	1.19
4T-3994/3920	84	74	99	106	5.5	3.3	4.5	0.40	1.49	0.82	1.18
4T-39590/39520	80	74	101	107	3.5	3.3	6.6	0.34	1.77	0.97	1.19
4T-HM212049/HM212010	82	75	110	116	3.5	1.5	11.1	0.34	1.78	0.98	1.86
4T-560/552A	81	75	109	116	3.5	3.3	9.4	0.35	1.73	0.95	1.92
4T-HM813844/HM813810	85	78	111	121	3.5	3.3	3.7	0.50	1.20	0.66	2.03
4T-641/633	83	77	116	124	3.5	3.3	11.4	0.36	1.66	0.91	2.41
4T-6386/6320	87	77	117	126	4.3	3.3	18.8	0.32	1.85	1.02	3.64
4T-641/632	83	77	118	125	3.5	3.3	11.4	0.36	1.66	0.91	2.74
4T-H414242/H414210	85	81	121	129	3.5	3.3	11.0	0.36	1.67	0.92	2.75
4T-399A/394A	78	74	101	104	2.3	1.3	0.7	0.40	1.49	0.82	0.764
4T-480/472	82	75	107	114	3.5	2	3.9	0.38	1.56	0.86	1.37
4T-560S/552A	83	76	109	116	3.5	3.3	9.4	0.35	1.73	0.95	1.87
4T-H414245/H414210	86	82	121	129	3.5	3.3	11.0	0.36	1.67	0.92	2.7
4T-H715343/H715311	90	84	118	132	3.5	3.3	8.7	0.47	1.27	0.70	3.24
4T-29675/29620	80	77	101	109	1.5	3.3	-0.9 ¹⁾	0.49	1.23	0.68	0.949
4T-33275/33462	84	77	104	112	3.5	3.3	2.6	0.44	1.38	0.76	1.28
4T-482/472	83	77	107	114	3.5	2	3.9	0.38	1.56	0.86	1.33
4T-47487/47420	84	78	107	114	3.5	3.3	6.1	0.36	1.67	0.92	1.47
4T-29675/29630	80	77	104	113	1.5	3.3	-0.9 ¹⁾	0.49	1.23	0.68	1.17
4T-566/563	85	78	112	120	3.5	3.3	8.3	0.36	1.65	0.91	1.92
4T-643/632	86	80	118	125	3.5	3.3	11.4	0.36	1.66	0.91	2.63
4T-655/653	88	82	131	139	3.5	3.3	8.0	0.41	1.47	0.81	3.28
4T-745A/742	88	82	134	142	3.5	3.3	12.0	0.33	1.84	1.01	3.92
4T-835/832	91	84	149	155	3.5	3.3	18.5	0.30	2.00	1.10	6.13
4T-34274/34478	81	78	110	116	2	2	-1.2 ¹⁾	0.45	1.33	0.73	1.11
# 4T-JLM813049/JLM813010	78	77	98	105	1	2.5	-0.3 ¹⁾	0.49	1.23	0.68	0.889
# 4T-JM612949/JM612910	83	77	103	110	3	2.5	2.5	0.43	1.39	0.77	1.13

1) " - " means that load center at outside on end of inner ring.

Tapered Roller Bearings

Inch series
J series

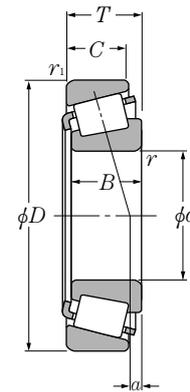

d 70.000 ~ 76.200mm

d	Boundary dimensions				dynamic kN	Basic load ratings			Limiting speeds	
	D	T	B	C		static	dynamic	static	grease	oil
	mm						kgf		min ⁻¹	
					C _r	C _{or}	C _r	C _{or}		
70.000	120.000	29.794	29.007	24.237	128	177	13 000	18 100	3 000	4 000
	150.000	41.275	39.688	25.400	199	234	20 300	23 900	2 400	3 200
71.438	117.475	30.162	30.162	23.812	117	175	11 900	17 900	3 000	4 000
	120.000	32.545	32.545	26.195	147	214	15 000	21 800	3 000	4 000
	127.000	36.512	36.170	28.575	163	229	16 600	23 300	2 900	3 800
	136.525	41.275	41.275	31.750	194	262	19 800	26 700	2 800	3 800
	136.525	41.275	41.275	31.750	226	293	23 100	29 900	2 700	3 700
73.025	136.525	46.038	46.038	36.512	224	355	22 800	36 500	2 600	3 500
	112.712	25.400	25.400	19.050	95.5	151	9 750	15 400	3 100	4 100
	117.475	30.162	30.162	23.812	117	175	11 900	17 900	3 000	4 000
	127.000	36.512	36.170	28.575	163	229	16 600	23 300	2 900	3 800
	139.992	36.512	36.098	28.575	178	265	18 100	27 100	2 600	3 400
73.817	149.225	53.975	54.229	44.450	287	410	29 300	41 500	2 500	3 400
	150.089	44.450	46.672	36.512	261	360	26 600	37 000	2 400	3 200
	112.712	25.400	25.400	19.050	95.5	151	9 750	15 400	3 100	4 100
74.612	127.000	36.512	36.170	28.575	163	229	16 600	23 300	2 900	3 800
	139.992	36.512	36.098	28.575	178	265	18 100	27 100	2 600	3 400
75.000	115.000	25.000	25.000	19.000	94.5	143	9 650	14 600	3 000	4 000
	120.000	31.000	29.500	25.000	131	197	13 300	20 100	2 900	3 900
	145.000	51.000	51.000	42.000	287	410	29 300	41 500	2 500	3 400
76.200	109.538	19.050	19.050	15.083	63.0	115	6 450	11 700	3 100	4 100
	121.442	24.608	23.012	17.462	91.0	127	9 300	13 000	2 900	3 800
	121.442	24.608	23.012	17.462	91.0	127	9 300	13 000	2 900	3 800
	127.000	30.162	31.000	22.225	135	194	13 800	19 800	2 800	3 700
	133.350	33.338	33.338	26.195	153	235	15 600	24 000	2 600	3 500
	133.350	39.688	39.688	32.545	177	305	18 000	31 000	2 600	3 500
	135.733	44.450	46.100	34.925	211	330	21 600	34 000	2 700	3 500
	136.525	30.162	29.769	22.225	129	189	13 200	19 300	2 600	3 500
	139.992	36.512	36.098	28.575	178	265	18 100	27 100	2 600	3 400
	139.992	36.512	36.098	28.575	178	265	18 100	27 100	2 600	3 400
	146.050	41.275	41.275	31.750	206	295	21 000	30 000	2 500	3 300
	149.225	53.975	54.229	44.450	287	410	29 300	41 500	2 500	3 400
	150.089	44.450	46.672	36.512	261	360	26 600	37 000	2 400	3 200

Note: 1. Chamfer dimensions on the back face of the inner and outer rings of the bearing are larger than maximum values for installation dimensions r_{as} and r_{1as} .
2. Bearing numbers marked " # " designate J-series bearings. The accuracy of these bearings is listed in Table 6.6 on page A-42.

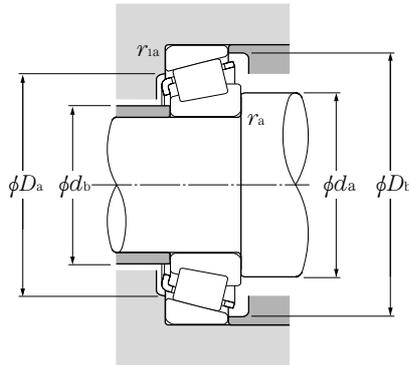

Equivalent radial load dynamic

$$P_r = XF_r + YF_a$$

$\frac{F_a}{F_r} \leq e$		$\frac{F_a}{F_r} > e$	
X	Y	X	Y
1	0	0.4	Y ₂

static

$$P_{or} = 0.5F_r + Y_oF_a$$

When $P_{or} < F_r$ use $P_{or} = F_r$

For values of e , Y_2 and Y_o see the table below.

Bearing numbers	Abutment and fillet dimensions						Load center mm	Constant e	Axial load factors		Mass kg (approx.)
	mm								a	Y ₂	
	d _a	d _b	D _a	D _b	r _{as} max	r _{1as} max					
4T-484/472	80	77	107	114	2	2	3.9	0.38	1.56	0.86	1.33
# 4T-JH913848/JH913811	92	82	126	146	2	3.3	-4.3 ¹⁾	0.78	0.77	0.42	3.08
4T-33281/33462	85	79	104	112	3.5	3.3	2.6	0.44	1.38	0.76	1.24
4T-47490/47420	86	79	107	114	3.5	3.3	6.1	0.36	1.67	0.92	1.42
4T-567A/563	86	80	112	120	3.5	3.3	8.3	0.36	1.65	0.91	1.87
4T-644/632	87	81	118	125	3.5	3.3	11.4	0.36	1.66	0.91	2.57
4T-H414249/H414210	89	83	121	129	3.5	3.3	11.0	0.36	1.67	0.92	2.58
4T-H715345/H715311	93	87	118	132	3.5	3.3	8.7	0.47	1.27	0.70	3.11
4T-29685/29620	86	80	101	109	3.5	3.3	-0.9 ¹⁾	0.49	1.23	0.68	0.873
4T-33287/33462	87	80	104	112	3.5	3.3	2.6	0.44	1.38	0.76	1.19
4T-567/563	88	81	112	120	3.5	3.3	8.3	0.36	1.65	0.91	1.82
4T-576/572	90	83	125	133	3.5	3.3	5.5	0.40	1.49	0.82	2.53
4T-6460/6420	93	87	129	140	3.5	3.3	14.8	0.36	1.66	0.91	4.42
4T-744/742	91	85	134	142	3.5	3.3	12.0	0.33	1.84	1.01	3.79
4T-29688/29620	83	80	101	109	1.5	3.3	-0.9 ¹⁾	0.49	1.23	0.68	0.86
4T-568/563	83	82	112	120	0.8	3.3	8.3	0.36	1.65	0.91	1.80
4T-577/572	91	85	125	133	3.5	3.3	5.5	0.40	1.49	0.82	2.48
# 4T-JLM714149/JLM714110	87	81	104	110	3	2.5	-0.3 ¹⁾	0.46	1.31	0.72	0.875
# 4T-JM714249/JM714210	88	83	108	115	3	2.5	1.9	0.44	1.35	0.74	1.29
# 4T-JH415647/JH415610	94	89	129	139	3	2.5	14.1	0.36	1.66	0.91	3.81
4T-L814749/L814710	84	82	100	105	1.5	1.5	-5.0 ¹⁾	0.50	1.20	0.66	0.579
4T-34300/34478	86	83	110	116	2	2	-1.2 ¹⁾	0.45	1.33	0.73	0.982
4T-34301/34478	89	83	110	116	3.5	2	-1.2 ¹⁾	0.45	1.33	0.73	0.977
4T-42687/42620	90	84	114	121	3.5	3.3	2.8	0.42	1.43	0.79	1.46
4T-47678/47620	97	85	119	128	6.4	3.3	3.9	0.40	1.48	0.82	1.92
4T-HM516442/HM516410	93	87	118	128	3.5	3.3	7.5	0.40	1.49	0.82	2.43
4T-5760/5735	94	88	119	130	3.5	3.3	11.0	0.41	1.48	0.81	2.75
4T-495A/493	92	86	122	130	3.5	3.3	0.7	0.44	1.35	0.74	1.83
4T-575/572	92	86	125	133	3.5	3.3	5.5	0.40	1.49	0.82	2.43
4T-575S/572	99	86	125	133	6.8	3.3	5.5	0.40	1.49	0.82	2.41
4T-659/653	93	87	131	139	3.5	3.3	8.0	0.41	1.47	0.81	3.04
4T-6461A/6420	108	89	129	140	9.7	3.3	14.8	0.36	1.66	0.91	4.23
4T-748S/742	93	87	134	142	3.5	3.3	12.0	0.33	1.84	1.01	3.66

1) " - " means that load center at outside on end of inner ring.

Inch series
J series

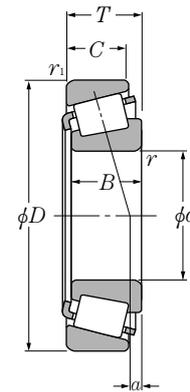

d 76.200 ~ 83.345mm

d	Boundary dimensions				dynamic kN	Basic load ratings			Limiting speeds	
	D	T	B	C		static	dynamic	static	grease	oil
	mm						kgf		min ⁻¹	
					C _r	C _{or}	C _r	C _{or}		
76.200	149.225	53.975	54.229	44.450	287	410	29 300	41 500	2 500	3 400
	161.925	53.975	55.100	42.862	310	460	31 500	47 000	2 300	3 000
	180.975	53.975	53.183	35.720	325	415	33 000	42 500	1 900	2 600
	190.500	57.150	57.531	46.038	445	610	45 000	62 000	1 900	2 600
77.788	117.475	25.400	25.400	19.050	99.5	162	10 200	16 500	2 900	3 900
	121.442	24.608	23.012	17.462	91.0	127	9 300	13 000	2 900	3 800
	127.000	30.162	31.000	22.225	135	194	13 800	19 800	2 800	3 700
	136.525	30.162	29.769	22.225	129	189	13 200	19 300	2 600	3 500
	136.525	46.038	46.038	36.512	224	355	22 800	36 500	2 600	3 500
79.375	146.050	41.275	41.275	31.750	206	295	21 000	30 000	2 500	3 300
	161.925	47.625	48.260	38.100	270	385	27 500	39 000	2 300	3 100
	190.500	57.150	57.531	46.038	445	610	45 000	62 000	1 900	2 600
80.000	130.000	35.000	34.000	28.500	166	249	16 900	25 400	2 700	3 600
80.962	133.350	33.338	33.338	26.195	153	235	15 600	24 000	2 600	3 500
	136.525	30.162	29.769	22.225	129	189	13 200	19 300	2 600	3 500
	139.992	36.512	36.098	28.575	178	265	18 100	27 100	2 600	3 400
	150.089	44.450	46.672	36.512	261	360	26 600	37 000	2 400	3 200
82.550	125.412	25.400	25.400	19.845	102	163	10 400	16 600	2 700	3 600
	133.350	33.338	33.338	26.195	153	235	15 600	24 000	2 600	3 500
	133.350	39.688	39.688	32.545	177	305	18 000	31 000	2 600	3 500
	136.525	30.162	29.769	22.225	129	189	13 200	19 300	2 600	3 500
	139.992	36.512	36.098	28.575	178	265	18 100	27 100	2 600	3 400
	139.992	36.512	36.098	28.575	178	265	18 100	27 100	2 600	3 400
	146.050	41.275	41.275	31.750	206	295	21 000	30 000	2 500	3 300
	150.089	44.450	46.672	36.512	261	360	26 600	37 000	2 400	3 200
	152.400	39.688	36.322	30.162	180	279	18 300	28 400	2 300	3 100
	152.400	41.275	41.275	31.750	206	295	21 000	30 000	2 500	3 300
	161.925	47.625	48.260	38.100	270	385	27 500	39 000	2 300	3 100
	161.925	53.975	55.100	42.862	310	460	31 500	47 000	2 300	3 000
168.275	53.975	56.363	41.275	340	460	34 500	46 500	2 200	3 000	
83.345	125.412	25.400	25.400	19.845	102	163	10 400	16 600	2 700	3 600
	125.412	25.400	25.400	19.845	102	163	10 400	16 600	2 700	3 600
	125.412	25.400	25.400	19.845	102	163	10 400	16 600	2 700	3 600

Note: 1. Chamfer dimensions on the back face of the inner and outer rings of the bearing are larger than maximum values for installation dimensions r_{is} and r_{ios} .
 2. As for the maximum value for inner and outer ring diameters of bearings whose bearing numbers are marked with "+" (inner ring) and "++" (outer ring), the precision class is an integer for class 4 and class 2 bearings only.

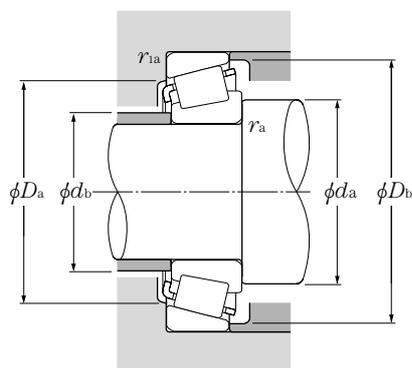

Equivalent radial load dynamic

$$P_r = XF_r + YF_a$$

$\frac{F_a}{F_r} \leq e$		$\frac{F_a}{F_r} > e$	
X	Y	X	Y
1	0	0.4	Y_2

static

$$P_{or} = 0.5F_r + Y_o F_a$$

When $P_{or} < F_r$ use $P_{or} = F_r$

For values of e , Y_2 and Y_o see the table below.

Bearing numbers	Abutment and fillet dimensions						Load center mm	Constant mm	Axial load factors		Mass kg (approx.)
	d_a	d_b	D_a	D_b	r_{as} max	r_{1as} max			a	e	
4T-6461/6420	96	89	129	140	3.5	3.3	14.8	0.36	1.66	0.91	4.26
4T-6576/6535	99	92	141	154	3.5	3.3	12.8	0.40	1.50	0.82	5.44
4T-H917840/H917810††	110	100	152	170	3.5	3.3	-0.5 ¹⁾	0.73	0.82	0.45	6.57
4T-HH221430/HH221410	101	95	171	179	3.5	3.3	14.4	0.33	1.79	0.99	8.69
4T-LM814849/LM814810	91	85	105	113	3.5	3.3	-2.3 ¹⁾	0.51	1.18	0.65	0.932
4T-34306/34478	90	84	110	116	3.5	2	-1.2 ¹⁾	0.45	1.33	0.73	0.943
4T-42690/42620	91	85	114	121	3.5	3.3	2.8	0.42	1.43	0.79	1.41
4T-495AS/493	93	87	122	130	3.5	3.3	0.7	0.44	1.35	0.74	1.78
4T-H715348/H715311	98	88	118	132	3.5	3.3	8.7	0.47	1.27	0.70	2.84
4T-661/653	96	90	131	139	3.5	3.3	8.0	0.41	1.47	0.81	2.91
4T-756A/752	106	91	144	150	8	3.3	12.0	0.34	1.76	0.97	4.55
4T-HH221431/HH221410	103	97	171	179	3.5	3.3	14.4	0.33	1.79	0.99	8.52
# 4T-JM515649/JM515610	94	88	117	125	3	2.5	4.9	0.39	1.54	0.85	1.73
4T-47681/47620	95	89	119	128	3.5	3.3	3.9	0.40	1.48	0.82	1.78
4T-496/493	95	89	122	130	3.5	3.3	0.7	0.44	1.35	0.74	1.69
4T-581/572	96	90	125	133	3.5	3.3	5.5	0.40	1.49	0.82	2.26
4T-740/742	101	91	134	142	5	3.3	12.0	0.33	1.84	1.01	3.43
4T-27687/27620	96	89	115	120	3.5	1.5	-0.6 ¹⁾	0.42	1.44	0.79	1.07
4T-47686/47620	97	90	119	128	3.5	3.3	3.9	0.40	1.48	0.82	1.72
4T-HM516448/HM516410	105	92	118	128	6.8	3.3	7.5	0.40	1.49	0.82	2.16
4T-495/493	97	90	122	130	3.5	3.3	0.7	0.44	1.35	0.74	1.64
4T-580/572	98	91	125	133	3.5	3.3	5.5	0.40	1.49	0.82	2.2
4T-582/572	104	91	125	133	6.8	3.3	5.5	0.40	1.49	0.82	2.19
4T-663/653	99	92	131	139	3.5	3.3	8.0	0.41	1.47	0.81	2.78
4T-749A/742	99	93	134	142	3.5	3.3	12.0	0.33	1.84	1.01	3.37
4T-595/592A	100	93	135	144	3.5	3.3	2.6	0.44	1.36	0.75	3.02
4T-663/652	99	92	134	141	3.5	3.3	8.0	0.41	1.47	0.81	3.15
4T-757/752	100	94	144	150	3.5	3.3	12.0	0.34	1.76	0.97	4.42
4T-6559C/6535	104	98	141	154	3.5	3.3	12.8	0.40	1.50	0.82	5.09
4T-842/832	101	94	149	155	3.5	3.3	18.5	0.30	2.00	1.10	5.46
4T-27689/27620	90	90	115	120	0.8	1.5	-0.6 ¹⁾	0.42	1.44	0.79	1.06
4T-27690/27620	96	90	115	120	3.5	1.5	-0.6 ¹⁾	0.42	1.44	0.79	1.05
4T-27691/27620	102	90	115	120	6.4	1.5	-0.6 ¹⁾	0.42	1.44	0.79	1.04

Note: 3. Bearing numbers marked " # " designate J-series bearings. The tolerances of these bearings is listed in Table 6.6 on page A-42.

1) " - " means that load center at outside on end of inner ring.

Tapered Roller Bearings

Inch series
J series

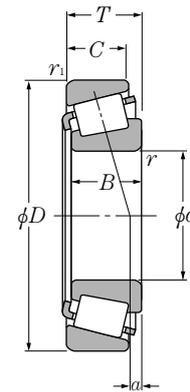

d 84.138 ~ 95.000mm

d	Boundary dimensions				dynamic kN	Basic load ratings			Limiting speeds	
	D	T	B	C		static	dynamic	static	grease	oil
	mm						kgf		min ⁻¹	
					C _r	C _{or}	C _r	C _{or}		
84.138	136.525	30.162	29.769	22.225	129	189	13 200	19 300	2 600	3 500
85.000	130.000	30.000	29.000	24.000	135	214	13 700	21 900	2 600	3 500
	140.000	39.000	38.000	31.500	197	297	20 100	30 500	2 500	3 400
85.026	150.089	44.450	46.672	36.512	261	360	26 600	37 000	2 400	3 200
85.725	133.350	30.162	29.769	22.225	129	189	13 200	19 300	2 600	3 500
	142.138	42.862	42.862	34.133	216	350	22 000	35 500	2 500	3 300
	146.050	41.275	41.275	31.750	206	295	21 000	30 000	2 500	3 300
	152.400	39.688	36.322	30.162	180	279	18 300	28 400	2 300	3 100
	161.925	47.625	48.260	38.100	270	385	27 500	39 000	2 300	3 100
87.960	148.430	28.575	28.971	21.433	138	215	14 100	21 900	2 300	3 100
88.900	121.442	15.083	15.083	11.112	56.5	88.0	5 750	9 000	2 700	3 600
	123.825	20.638	20.638	16.670	80.0	141	8 150	14 400	2 700	3 500
	148.430	28.575	28.971	21.433	138	215	14 100	21 900	2 300	3 100
	152.400	39.688	36.322	30.162	180	279	18 300	28 400	2 300	3 100
	161.925	47.625	48.260	38.100	270	385	27 500	39 000	2 300	3 100
	161.925	53.975	55.100	42.862	310	460	31 500	47 000	2 300	3 000
	168.275	53.975	56.363	41.275	340	460	34 500	46 500	2 200	3 000
89.974	146.975	40.000	40.000	32.500	227	340	23 200	34 500	2 400	3 200
90.000	145.000	35.000	34.000	27.000	189	279	19 300	28 400	2 400	3 200
	155.000	44.000	44.000	35.500	270	385	27 500	39 000	2 300	3 100
	190.000	50.800	46.038	31.750	281	365	28 700	37 000	1 800	2 400
90.488	161.925	47.625	48.260	38.100	270	385	27 500	39 000	2 300	3 100
92.075	146.050	33.338	34.925	26.195	163	266	16 700	27 100	2 400	3 100
	152.400	39.688	36.322	30.162	180	279	18 300	28 400	2 300	3 100
	168.275	41.275	41.275	30.162	222	340	22 700	35 000	2 100	2 800
93.662	148.430	28.575	28.971	21.433	138	215	14 100	21 900	2 300	3 100
95.000	150.000	35.000	34.000	27.000	180	279	18 300	28 400	2 300	3 100

Note: 1. Chamfer dimensions on the back face of the inner and outer rings of the bearing are larger than maximum values for installation dimensions r_{is} and r_{ios} .
 2. As for the maximum value for inner and outer ring diameters of bearings whose bearing numbers are marked with "+" (inner ring) and "++" (outer ring), the precision class is an integer for class 4 and class 2 bearings only.

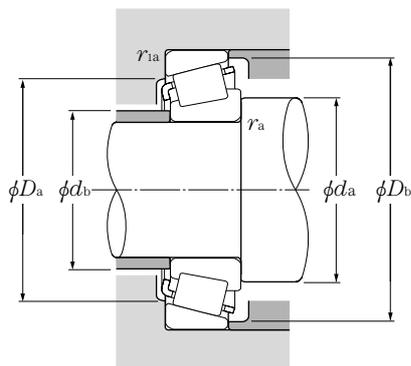

Equivalent radial load dynamic

$$P_r = XF_r + YF_a$$

$\frac{F_a}{F_r} \leq e$		$\frac{F_a}{F_r} > e$	
X	Y	X	Y
1	0	0.4	Y_2

static

$$P_{or} = 0.5F_r + Y_0F_a$$

When $P_{or} < F_r$ use $P_{or} = F_r$

For values of e , Y_2 and Y_0 see the table below.

Bearing numbers	Abutment and fillet dimensions						Load center mm	Constant e	Axial load factors		Mass kg (approx.)
	d_a	d_b	D_a	D_b	r_{as} max	r_{1as} max			Y_2	Y_0	
4T-498/493	98	91	122	130	3.5	3.3	0.7	0.44	1.35	0.74	1.6
# 4T-JM716648/JM716610	104	92	117	125	6	2.5	0.2	0.44	1.35	0.74	1.37
# 4T-JHM516849/JHM516810	100	94	125	134	3	2.5	5.9	0.41	1.47	0.81	2.3
4T-749/742	101	95	134	142	3.5	3.3	12.0	0.33	1.84	1.01	3.25
4T-497/492A	99	93	120	128	3.5	3.3	0.7	0.44	1.35	0.74	1.43
4T-HM617049/HM617010	106	95	125	137	4.8	3.3	6.9	0.43	1.39	0.76	2.69
4T-665/653	102	95	131	139	3.5	3.3	8.0	0.41	1.47	0.81	2.65
4T-596/592A	102	96	135	144	3.5	3.3	2.6	0.44	1.36	0.75	2.9
4T-758/752	103	97	144	150	3.5	3.3	12.0	0.34	1.76	0.97	4.26
4T-42346/42584	103	98	134	142	3	3	-3.0 ¹⁾	0.49	1.22	0.67	1.99
4T-LL217849/LL217810	97	94	115	117	1.5	1.5	-2.9 ¹⁾	0.33	1.81	1.00	0.452
4T-L217849/L217810	97	94	116	119	1.5	1.5	-0.7 ¹⁾	0.33	1.82	1.00	0.737
4T-42350/42584	104	98	134	142	3	3	-3.0 ¹⁾	0.49	1.22	0.67	1.96
4T-593/592A	104	98	135	144	3.5	3.3	2.6	0.44	1.36	0.75	2.78
4T-759/752	106	99	144	150	3.5	3.3	12.0	0.34	1.76	0.97	4.09
4T-6580/6535	109	102	141	154	3.5	3.3	12.8	0.40	1.50	0.82	4.73
4T-850/832	106	100	149	155	3.5	3.3	18.5	0.30	2.00	1.10	5.08
4T-HM218248†/HM218210†	112	99	133	141	7	3.5	8.6	0.33	1.80	0.99	2.55
# 4T-JM718149/JM718110	105	99	131	139	3	2.5	2.0	0.44	1.35	0.74	2.14
# 4T-JHM318448/JHM318410	106	100	140	148	3	2.5	10.1	0.34	1.76	0.97	3.32
# 4T-J90354/J90748	120	112	162	179	3.5	3.3	-12.9 ¹⁾	0.87	0.69	0.38	6.32
4T-760/752	107	101	144	150	3.5	3.3	12.0	0.34	1.76	0.97	4.01
4T-47890/47820	107	101	131	140	3.5	3.3	0.6	0.45	1.34	0.74	2.08
4T-598A/592A	113	101	135	144	6.4	3.3	2.6	0.44	1.36	0.75	2.63
4T-681/672	110	104	149	160	3.5	3.3	3.0	0.47	1.28	0.70	3.87
4T-42368/42584	107	102	134	142	3	3	-3.0 ¹⁾	0.49	1.22	0.67	1.8
# 4T-JM719149/JM719113	109	104	135	143	3	2.5	1.7	0.44	1.36	0.75	2.19

Note: 3. Bearing numbers marked " # " designate J-series bearings. The tolerances of these bearings is listed in Table 6.6 on page A-42.

1) " - " means that load center at outside on end of inner ring.

Tapered Roller Bearings

Inch series
J series

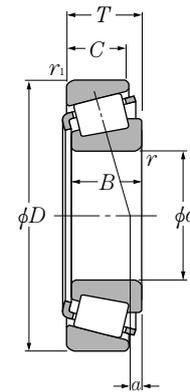

d 95.250 ~ 109.538mm

d	Boundary dimensions				dynamic kN	Basic load ratings			Limiting speeds	
	D	T	B	C		static	dynamic	static	grease	oil
	mm						kgf		min ⁻¹	
					C _r	C _{or}	C _r	C _{or}		
95.250	130.175	20.638	21.433	16.670	81.0	147	8 300	15 000	2 500	3 300
	146.050	33.338	34.925	26.195	163	266	16 700	27 100	2 400	3 100
	147.638	35.717	36.322	26.192	180	279	18 300	28 400	2 300	3 100
	148.430	28.575	28.971	21.433	138	215	14 100	21 900	2 300	3 100
	152.400	39.688	36.322	30.162	180	279	18 300	28 400	2 300	3 100
	157.162	36.512	36.116	26.195	188	305	19 200	31 000	2 200	2 900
	168.275	41.275	41.275	30.162	222	340	22 700	35 000	2 100	2 800
	190.500	57.150	57.531	46.038	445	610	45 000	62 000	1 900	2 600
96.838	148.430	28.575	28.971	21.433	138	215	14 100	21 900	2 300	3 100
	188.912	50.800	46.038	31.750	281	365	28 700	37 000	1 800	2 400
98.425	157.162	36.512	36.116	26.195	188	305	19 200	31 000	2 200	2 900
	168.275	41.275	41.275	30.162	222	340	22 700	35 000	2 100	2 800
99.974	212.725	66.675	66.675	53.975	575	810	58 500	82 500	1 700	2 300
100.000	155.000	36.000	35.000	28.000	192	310	19 600	31 500	2 200	2 900
100.012	157.162	36.512	36.116	26.195	188	305	19 200	31 000	2 200	2 900
101.600	157.162	36.512	36.116	26.195	188	305	19 200	31 000	2 200	2 900
	168.275	41.275	41.275	30.162	222	340	22 700	35 000	2 100	2 800
	180.975	47.625	48.006	38.100	285	430	29 100	44 000	2 000	2 700
	190.500	57.150	57.531	44.450	380	555	38 500	56 500	2 000	2 600
	190.500	57.150	57.531	46.038	445	610	45 000	62 000	1 900	2 600
	190.500	57.150	57.531	46.038	445	610	45 000	62 000	1 900	2 600
	212.725	66.675	66.675	53.975	475	695	48 500	71 000	1 800	2 300
212.725	66.675	66.675	53.975	575	810	58 500	82 500	1 700	2 300	
104.775	180.975	47.625	48.006	38.100	285	430	29 100	44 000	2 000	2 700
107.950	158.750	23.020	21.438	15.875	102	166	10 400	17 000	2 100	2 800
	159.987	34.925	34.925	26.988	167	320	17 100	33 000	2 100	2 800
	165.100	36.512	36.512	26.988	191	315	19 500	32 000	2 100	2 700
	212.725	66.675	66.675	53.975	475	695	48 500	71 000	1 800	2 300
109.538	158.750	23.020	21.438	15.875	102	166	10 400	17 000	2 100	2 800

Note: 1. Chamfer dimensions on the back face of the inner and outer rings of the bearing are larger than maximum values for installation dimensions r_{is} and r_{ios} .
 2. As for the maximum value for inner and outer ring diameters of bearings whose bearing numbers are marked with "+" (inner ring) and "++" (outer ring), the precision class is an integer for class 4 and class 2 bearings only.

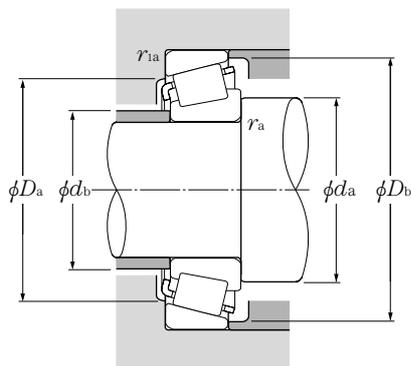

Equivalent radial load dynamic

$$P_r = XF_r + YF_a$$

$\frac{F_a}{F_r} \leq e$		$\frac{F_a}{F_r} > e$	
X	Y	X	Y
1	0	0.4	Y ₂

static

$$P_{or} = 0.5F_r + Y_oF_a$$

When $P_{or} < F_r$ use $P_{or} = F_r$

For values of e , Y_2 and Y_o see the table below.

Bearing numbers	Abutment and fillet dimensions						Load center mm	Constant e	Axial load factors		Mass kg (approx.)
	mm								a	Y ₂	
	d _a	d _b	D _a	D _b	r _{as} max	r _{1as} max					
4T-L319249/L319210	103	101	122	125	1.5	1.5	-1.0 ¹⁾	0.35	1.72	0.95	0.789
4T-47896/47820	110	103	131	140	3.5	3.3	0.6	0.45	1.34	0.74	1.95
4T-594A/592XE	113	104	135	142	5	0.8	2.6	0.44	1.36	0.75	2.09
4T-42375/42584	108	103	134	142	3	3	-3.0 ¹⁾	0.49	1.22	0.67	1.75
4T-594/592A	110	104	135	144	3.5	3.3	2.6	0.44	1.36	0.75	2.51
4T-52375/52618	112	105	142	152	3.5	3.3	0.6	0.47	1.26	0.69	2.76
4T-683/672	113	106	149	160	3.5	3.3	3.0	0.47	1.28	0.70	3.72
4T-HH221440/HH221410	125	110	171	179	8	3.3	14.4	0.33	1.79	0.99	7.5
4T-42381/42584	110	104	134	142	3.5	3.3	-3.0 ¹⁾	0.49	1.22	0.67	1.69
4T-90381/90744	125	113	161	179	3.5	3.3	-12.9 ¹⁾	0.87	0.69	0.38	5.67
4T-52387/52618	114	108	142	152	3.5	3.3	0.6	0.47	1.26	0.69	2.62
4T-685/672	116	109	149	160	3.5	3.3	3.0	0.47	1.28	0.70	3.56
4T-HH224334†/HH224310	124	120	192	202	3.5	3.3	18.9	0.33	1.84	1.01	11.5
# 4T-JM720249/JM720210	115	109	140	149	3	2.5	-0.3 ¹⁾	0.47	1.27	0.70	2.4
4T-52393/52618	116	109	142	152	3.5	3.3	0.6	0.47	1.26	0.69	2.55
4T-52400/52618	117	111	142	152	3.5	3.3	0.6	0.47	1.26	0.69	2.48
4T-687/672	118	112	149	160	3.5	3.3	3.0	0.47	1.28	0.70	3.4
4T-780/772††	119	113	161	168	3.5	3.3	8.1	0.39	1.56	0.86	5.11
4T-861/854	129	114	170	174	8	3.3	15.3	0.33	1.79	0.99	7
4T-HH221449/HH221410	131	116	171	179	8	3.3	14.4	0.33	1.79	0.99	7.06
4T-HH221449A/HH221410	122	116	171	179	3.5	3.3	14.4	0.33	1.79	0.99	7.06
4T-941/932	130	117	187	193	7	3.3	19.7	0.33	1.84	1.01	11.2
4T-HH224335/HH224310	132	121	192	202	7	3.3	18.9	0.33	1.84	1.01	11.3
4T-782/772††	122	116	161	168	3.5	3.3	8.1	0.39	1.56	0.86	4.92
4T-37425/37625	122	115	143	152	3.5	3.3	-14.0 ¹⁾	0.61	0.99	0.54	1.37
4T-LM522546/LM522510	122	116	146	154	3.5	3.3	1.4	0.40	1.49	0.82	2.37
4T-56425/56650	123	117	149	159	3.5	3.3	-2.0 ¹⁾	0.50	1.21	0.66	2.69
4T-936/932	137	122	187	193	8	3.3	19.7	0.33	1.84	1.01	10.7
4T-37431/37625	123	116	143	152	3.5	3.3	-14.0 ¹⁾	0.61	0.99	0.54	1.33

Note: 3. Bearing numbers marked " # " designate J-series bearings. The tolerances of these bearings is listed in Table 6.6 on page A-42.

1) " - " means that load center at outside on end of inner ring.

Inch series
J series

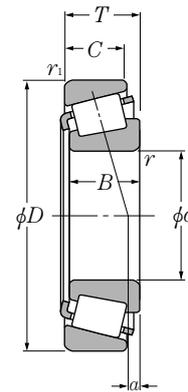

d 109.987 ~ 133.350mm

d	Boundary dimensions				dynamic kN	Basic load ratings			Limiting speeds	
	D	T	B	C		static	dynamic	static	grease	oil
	mm						kgf		min ⁻¹	
					C _r	C _{or}	C _r	C _{or}		
109.987	159.987	34.925	34.925	26.988	167	320	17 100	33 000	2 100	2 800
109.992	177.800	41.275	41.275	30.162	232	375	23 600	38 000	1 900	2 600
110.000	165.000	35.000	35.000	26.500	191	315	19 500	32 000	2 100	2 700
	180.000	47.000	46.000	38.000	305	480	31 000	49 000	1 900	2 600
111.125	214.312	55.562	52.388	39.688	405	560	41 500	57 000	1 500	2 000
114.300	177.800	41.275	41.275	30.162	232	375	23 600	38 000	1 900	2 600
	180.975	34.925	31.750	25.400	169	245	17 200	25 000	1 900	2 500
	212.725	66.675	66.675	53.975	475	695	48 500	71 000	1 800	2 300
	212.725	66.675	66.675	53.975	575	810	58 500	82 500	1 700	2 300
	228.600	53.975	49.428	38.100	430	620	44 000	63 500	1 400	1 900
115.087	190.500	47.625	49.212	34.925	300	475	30 500	48 500	1 800	2 500
117.475	180.975	34.925	31.750	25.400	169	245	17 200	25 000	1 900	2 500
120.000	170.000	25.400	25.400	19.050	127	210	13 000	21 400	2 000	2 600
120.650	234.950	63.500	63.500	49.212	525	825	53 500	84 000	1 500	2 000
123.825	182.562	39.688	38.100	33.338	224	435	22 900	44 000	1 800	2 400
127.000	182.562	39.688	38.100	33.338	224	435	22 900	44 000	1 800	2 400
	196.850	46.038	46.038	38.100	310	550	31 500	56 500	1 700	2 200
	215.900	47.625	47.625	34.925	320	540	32 500	55 000	1 600	2 100
	228.600	53.975	49.428	38.100	320	445	32 500	45 000	1 400	1 900
	228.600	53.975	49.428	38.100	430	620	44 000	63 500	1 400	1 900
	230.000	63.500	63.500	49.212	525	825	53 500	84 000	1 500	2 000
254.000	77.788	82.550	61.912	740	1 070	75 500	109 000	1 400	1 900	
128.588	206.375	47.625	47.625	34.925	315	520	32 000	53 000	1 700	2 200
130.175	196.850	46.038	46.038	38.100	310	550	31 500	56 500	1 700	2 200
	206.375	47.625	47.625	34.925	315	520	32 000	53 000	1 700	2 200
133.350	177.008	25.400	26.195	20.638	126	259	12 900	26 400	1 800	2 400

Note: 1. Chamfer dimensions on the back face of the inner and outer rings of the bearing are larger than maximum values for installation dimensions r_{is} and r_{ios} .
 2. As for the maximum value for inner and outer ring diameters of bearings whose bearing numbers are marked with "+" (inner ring) and "++" (outer ring), the precision class is an integer for class 4 and class 2 bearings only.

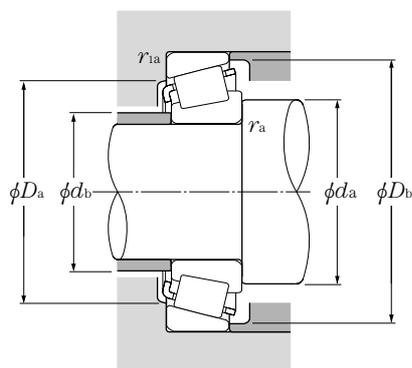

Equivalent radial load dynamic

$$P_r = XF_r + YF_a$$

$\frac{F_a}{F_r} \leq e$		$\frac{F_a}{F_r} > e$	
X	Y	X	Y
1	0	0.4	Y ₂

static

$$P_{or} = 0.5F_r + Y_0F_a$$

When $P_{or} < F_r$ use $P_{or} = F_r$

For values of e , Y_2 and Y_0 see the table below.

Bearing numbers	Abutment and fillet dimensions						Load center mm	Constant e	Axial load factors		Mass kg (approx.)
	mm								a	Y ₂	
	d _a	d _b	D _a	D _b	r _{as} max	r _{1as} max					
4T-LM522548/LM522510	133	118	146	154	8	3.3	1.4	0.40	1.49	0.82	2.24
4T-64433/64700	128	121	160	172	3.5	3.3	-1.1 ¹⁾	0.52	1.16	0.64	3.77
# 4T-JM822049/JM822010	124	119	149	159	3	2.5	-3.0 ¹⁾	0.50	1.21	0.66	2.52
# 4T-JHM522649/JHM522610	127	122	162	172	3	2.5	6.0	0.41	1.48	0.81	4.61
4T-H924045/H924010	139	131	186	205	3.5	3.3	-6.8 ¹⁾	0.67	0.89	0.49	8.18
4T-64450/64700	131	125	160	172	3.5	3.3	-1.1 ¹⁾	0.52	1.16	0.64	3.52
4T-68450/68712††	130	123	163	172	3.5	3.3	-5.4 ¹⁾	0.50	1.21	0.66	2.93
4T-938/932	141	128	187	193	7	3.3	19.7	0.33	1.84	1.01	10.1
4T-HH224346/HH224310	143	131	192	202	7	3.3	18.9	0.33	1.84	1.01	10.2
4T-HM926740/HM926710	146	142	200	219	3.5	3.3	-13.5 ¹⁾	0.74	0.81	0.45	9.76
4T-71453/71750	133	126	171	181	3.5	3.3	6.7	0.42	1.44	0.79	5.11
4T-68462/68712††	132	125	163	172	3.5	3.3	-5.4 ¹⁾	0.50	1.21	0.66	2.78
# 4T-JL724348/JL724314	132	127	156	163	3.3	3.3	-7.9 ¹⁾	0.46	1.31	0.72	1.67
4T-95475/95925	149	137	209	217	6.4	3.3	14.0	0.37	1.62	0.89	12.6
4T-48286/48220	139	133	168	176	3.5	3.3	5.7	0.31	1.97	1.08	3.52
4T-48290/48220	141	135	168	176	3.5	3.3	5.7	0.31	1.97	1.08	3.33
4T-67388/67322	144	138	180	189	3.5	3.3	6.3	0.34	1.74	0.96	5.1
4T-74500/74850	148	141	196	208	3.5	3.3	-2.2 ¹⁾	0.49	1.23	0.68	7.05
4T-97500/97900	151	144	197	213	3.5	3.3	-13.4 ¹⁾	0.74	0.81	0.45	8.43
4T-HM926747/HM926710	156	143	200	219	3.5	3.3	-13.5 ¹⁾	0.74	0.81	0.45	8.83
4T-95500/95905	154	142	207	217	6.4	3.3	14.0	0.37	1.62	0.89	12.9
4T-HH228349/HH228310	164	148	223	234	9.7	6.4	23.4	0.32	1.87	1.03	19.5
4T-799/792	146	140	186	198	3.3	3.3	1.9	0.46	1.31	0.72	5.77
4T-67389/67322	146	141	180	189	3.5	3.3	6.3	0.34	1.74	0.96	4.87
4T-799A/792	148	142	186	198	3.5	3.3	1.9	0.46	1.31	0.72	5.65
4T-L327249/L327210	142	140	167	171	1.5	1.5	-3.7 ¹⁾	0.35	1.72	0.95	1.7

Note: 3. Bearing numbers marked " # " designate J-series bearings. The tolerances of these bearings is listed in Table 6.6 on page A-42.

1) " - " means that load center at outside on end of inner ring.

Tapered Roller Bearings

Inch series
J series

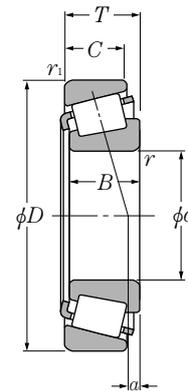

d 133.350 ~ 196.850mm

d	Boundary dimensions				dynamic kN	Basic load ratings			Limiting speeds	
	D	T	B	C		static	dynamic	static	grease	oil
	mm						kgf		min ⁻¹	
					C _r	C _{or}	C _r	C _{or}		
133.350	190.500	39.688	39.688	33.338	236	475	24 100	48 500	1 700	2 300
	196.850	46.038	46.038	38.100	310	550	31 500	56 500	1 700	2 200
	196.850	46.038	46.038	38.100	310	550	31 500	56 500	1 700	2 200
	215.900	47.625	47.625	34.925	320	540	32 500	55 000	1 600	2 100
	234.950	63.500	63.500	49.212	525	825	53 500	84 000	1 500	2 000
136.525	190.500	39.688	39.688	33.338	236	475	24 100	48 500	1 700	2 300
	228.600	57.150	57.150	44.450	445	735	45 500	75 000	1 500	2 000
139.700	215.900	47.625	47.625	34.925	320	540	32 500	55 000	1 600	2 100
	228.600	57.150	57.150	44.450	445	735	45 500	75 000	1 500	2 000
	254.000	66.675	66.675	47.625	550	910	56 000	92 500	1 400	1 800
142.875	200.025	41.275	39.688	34.130	239	490	24 300	50 000	1 600	2 100
	200.025	41.275	39.688	34.130	239	490	24 300	50 000	1 600	2 100
146.050	193.675	28.575	28.575	23.020	165	340	16 800	35 000	1 600	2 200
	254.000	66.675	66.675	47.625	550	910	56 000	92 500	1 400	1 800
152.400	192.088	25.000	24.000	19.000	130	261	13 200	26 700	1 600	2 100
	222.250	46.830	46.830	34.925	315	585	32 000	60 000	1 500	2 000
158.750	205.583	23.812	23.812	18.258	126	247	12 900	25 200	1 500	2 000
	225.425	41.275	39.688	33.338	254	555	25 900	56 500	1 400	1 900
165.100	225.425	41.275	39.688	33.338	254	555	25 900	56 500	1 400	1 900
170.000	230.000	39.000	38.000	31.000	282	520	28 700	53 000	1 400	1 800
177.800	227.012	30.162	30.162	23.020	181	415	18 500	42 000	1 300	1 800
	247.650	47.625	47.625	38.100	340	690	35 000	70 500	1 300	1 700
180.000	250.000	47.000	45.000	37.000	370	710	37 500	72 500	1 300	1 700
190.000	260.000	46.000	44.000	36.500	365	720	37 000	73 500	1 200	1 600
196.850	241.300	23.812	23.017	17.462	160	330	16 300	33 500	1 200	1 600

Note: 1. Chamfer dimensions on the back face of the inner and outer rings of the bearing are larger than maximum values for installation dimensions r_{as} and r_{1as} .
2. Bearing numbers marked " # " designate J-series bearings. The tolerances of these bearings is listed in Table 6.6 on page A-42.

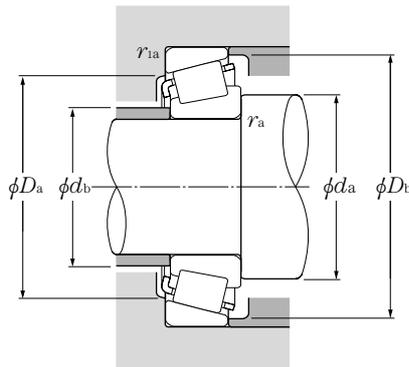

Equivalent radial load dynamic

$$P_r = XF_r + YF_a$$

$\frac{F_a}{F_r} \leq e$		$\frac{F_a}{F_r} > e$	
X	Y	X	Y
1	0	0.4	Y ₂

static

$$P_{or} = 0.5F_r + Y_oF_a$$

When $P_{or} < F_r$ use $P_{or} = F_r$

For values of e , Y_2 and Y_o see the table below.

Bearing numbers	Abutment and fillet dimensions						Load center mm	Constant e	Axial load factors		Mass kg (approx.)
	mm								a	e	
	d _a	d _b	D _a	D _b	r _{as} max	r _{1as} max					
4T-48385/48320	148	142	177	184	3.5	3.3	4.0	0.32	1.87	1.03	3.64
4T-67390/67322	149	143	180	189	3.5	3.3	6.3	0.34	1.74	0.96	4.63
4T-67391/67322	157	143	180	189	8	3.3	6.3	0.34	1.74	0.96	4.59
4T-74525/74850	152	146	196	208	3.5	3.3	-2.2 ¹⁾	0.49	1.23	0.68	6.56
4T-95525/95925	166	148	209	217	9.7	3.3	14.0	0.37	1.62	0.89	11.3
4T-48393/48320	151	144	177	184	3.5	3.3	4.0	0.32	1.87	1.03	3.43
4T-896/892	156	150	205	216	3.5	3.3	6.0	0.42	1.43	0.78	9.07
4T-74550/74850	158	151	196	208	3.5	3.3	-2.2 ¹⁾	0.49	1.23	0.68	6.05
4T-898/892	160	153	205	216	3.5	3.3	6.0	0.42	1.43	0.78	8.76
4T-99550/99100	170	156	227	238	7	3.3	12.1	0.41	1.47	0.81	14.3
4T-48684/48620	166	151	185	193	8	3.3	3.1	0.34	1.78	0.98	3.85
4T-48685/48620	158	151	185	193	3.5	3.3	3.1	0.34	1.78	0.98	3.89
4T-36690/36620	155	153	182	188	1.5	1.5	-5.0 ¹⁾	0.37	1.63	0.90	2.27
4T-99575/99100	175	162	227	238	7	3.3	12.1	0.41	1.47	0.81	13.5
4T-L630349/L630310	162	158	183	187	2	2	-10.0 ¹⁾	0.42	1.44	0.79	1.53
4T-M231648/M231610	178	163	207	213	8	1.5	5.9	0.33	1.8	0.99	5.72
4T-L432349/L432310	168	166	195	199	1.5	1.5	-9.8 ¹⁾	0.37	1.61	0.88	1.89
4T-46780/46720	176	169	209	218	3.5	3.3	-2.6 ¹⁾	0.38	1.57	0.86	5.2
4T-46790/46720	181	174	209	218	3.5	3.3	-2.6 ¹⁾	0.38	1.57	0.86	4.69
# 4T-JHM534149/JHM534110	184	178	217	224	3	2.5	-4.7 ¹⁾	0.38	1.57	0.86	4.37
4T-36990/36920	188	186	214	221	1.5	1.5	-12.8 ¹⁾	0.44	1.36	0.75	2.92
4T-67790/67720	194	188	229	240	3.5	3.3	-4.8 ¹⁾	0.44	1.36	0.75	6.57
# 4T-JM736149/JM736110	196	190	232	243	3	2.5	-9.0 ¹⁾	0.48	1.25	0.69	6.76
# 4T-JM738249/JM738210	206	200	242	252	3	2.5	-10.9 ¹⁾	0.48	1.26	0.69	6.85
4T-LL639249/LL639210	205	203	232	236	1.5	1.5	-17.3 ¹⁾	0.42	1.44	0.79	2.07

1) " - " means that load center at outside on end of inner ring.

Double Row Tapered Roller Bearings

Back-to-back arrangement

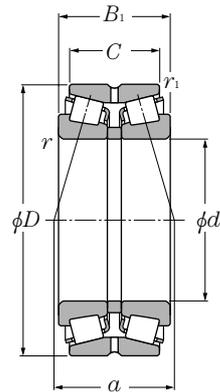

d 40 ~ 70mm

d	Boundary dimensions					dynamic kN	Basic load ratings			Limiting speeds	
	D	B ₁	C	r _{s min} ¹⁾	r _{1s min} ¹⁾		static kN	dynamic kgf	static kgf	grease min ⁻¹	oil min ⁻¹
40	80	45	37.5	1.5	0.6	105	134	10 700	13 700	4 100	5 500
	80	55	43.5	1.5	0.6	136	187	13 900	19 100	4 100	5 500
	90	56	39.5	2	0.6	132	171	13 500	17 400	3 200	4 200
	90	56	45.5	2	0.6	157	204	16 000	20 800	3 700	4 900
45	85	47	37.5	1.5	0.6	116	157	11 800	16 000	3 700	4 900
	85	55	43.5	1.5	0.6	141	200	14 300	20 400	3 700	4 900
	100	60	41.5	2	0.6	165	218	16 800	22 200	2 800	3 800
	100	60	49.5	2	0.6	191	251	19 500	25 600	3 300	4 400
50	90	49	39.5	1.5	0.6	132	186	13 500	18 900	3 400	4 500
	90	55	43.5	1.5	0.6	150	218	15 300	22 200	3 400	4 500
	110	64	43.5	2.5	0.6	194	260	19 800	26 600	2 600	3 500
	110	64	51.5	2.5	0.6	227	305	23 200	31 000	3 000	4 000
	110	90	71.5	2.5	0.6	315	465	32 000	47 500	3 000	4 000
55	100	51	41.5	2	0.6	160	221	16 300	22 600	3 100	4 100
	100	60	48.5	2	0.6	186	269	18 900	27 400	3 100	4 100
	120	70	49	2.5	0.6	226	305	23 100	31 500	2 400	3 100
	120	70	57	2.5	0.6	266	360	27 100	36 500	2 700	3 700
	120	97	76	2.5	0.6	370	550	37 500	56 000	2 700	3 700
60	110	53	43.5	2	0.6	180	249	18 300	25 400	2 800	3 800
	110	66	54.5	2	0.6	223	330	22 700	33 500	2 800	3 800
	130	74	51	3	1	258	350	26 300	36 000	2 200	2 900
	130	74	59	3	1	310	420	31 500	43 000	2 500	3 400
	130	104	81	3	1	420	625	42 500	64 000	2 500	3 400
65	120	56	46.5	2	0.6	211	295	21 500	30 000	2 600	3 500
	120	73	61.5	2	0.6	273	410	27 800	42 000	2 600	3 500
	140	79	53	3	1	297	410	30 500	41 500	2 000	2 700
	140	79	63	3	1	350	475	35 500	48 500	2 300	3 100
	140	108	84	3	1	470	700	47 500	71 500	2 300	3 100
70	125	59	48.5	2	0.6	225	325	23 000	33 000	2 400	3 200
	125	74	61.5	2	0.6	285	440	29 000	45 000	2 400	3 200
	150	83	57	3	1	330	460	33 500	46 500	1 900	2 500
	150	83	67	3	1	395	545	40 000	55 500	2 200	2 900
	150	116	92	3	1	530	805	54 000	82 500	2 200	2 900

1) Minimum allowable dimension for chamfer dimension r or r₁.

● Double Row Tapered Roller Bearings

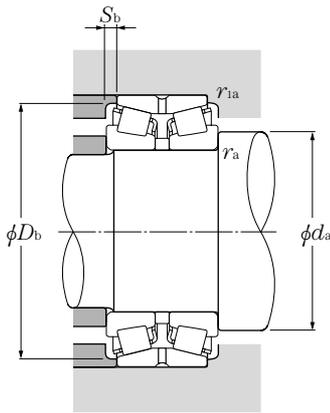

Equivalent radial load
dynamic

$$P_r = XF_r + YF_a$$

$\frac{F_a}{F_r} \leq e$		$\frac{F_a}{F_r} > e$	
X	Y	X	Y
1	Y ₁	0.67	Y ₂

static

$$P_{or} = F_r + Y_o F_a$$

For values of e , Y_2 and Y_o see the table below.

Bearing numbers	Abutment and fillet dimensions					Load center mm	Constant	Axial load factors			Mass kg (approx.)
	d_a min	D_b min	S_b min	r_{as} max	r_{1as} max			a	e	Y_1	
4T-430208X	48.5	75	3.5	1.5	0.6	38.5	0.37	1.80	2.68	1.76	0.929
4T-432208X	48.5	75	5.5	1.5	0.6	43	0.37	1.80	2.68	1.76	1.18
4T-430308DX	50	86.5	8	2	0.6	64.5	0.83	0.82	1.22	0.80	1.56
4T-430308	50	82	5	2	0.6	44.5	0.35	1.96	2.91	1.91	1.61
4T-430209	53.5	80	4.5	1.5	0.6	42	0.40	1.67	2.48	1.63	1.04
4T-432209	53.5	81	5.5	1.5	0.6	46	0.40	1.67	2.48	1.63	1.27
*4T-430309DX	55	96	9	2	0.6	70	0.83	0.82	1.22	0.80	2.11
4T-430309	55	93	5	2	0.6	47.5	0.35	1.96	2.91	1.91	2.11
4T-430210	58.5	85	4.5	1.5	0.6	44.5	0.42	1.61	2.39	1.57	1.18
432210U	58.5	85	5.5	1.5	0.6	47.5	0.42	1.61	2.39	1.57	1.36
4T-430310DX	62	105	10	2	0.6	75	0.83	0.82	1.22	0.80	2.65
4T-430310	62	102	6	2	0.6	51	0.35	1.96	2.91	1.91	2.72
432310U	62	102	9	2	0.6	62.5	0.35	1.96	2.91	1.91	3.98
4T-430211X	65	94	4.5	2	0.6	47	0.40	1.67	2.48	1.63	1.55
432211U	65	95	5.5	2	0.6	51	0.40	1.67	2.48	1.63	1.85
4T-430311DX	67	113	10.5	2	0.6	83	0.83	0.82	1.22	0.80	3.42
430311XU	67	111	6.5	2	0.6	55.5	0.35	1.96	2.91	1.91	3.48
432311U	67	111	10.5	2	0.6	66.5	0.35	1.96	2.91	1.91	5.05
4T-430212X	70	103	4.5	2	0.6	49.5	0.40	1.67	2.48	1.63	1.99
432212U	70	104	5.5	2	0.6	56	0.40	1.67	2.48	1.63	2.49
4T-430312DX	74	124	11.5	2.5	1	88.5	0.83	0.82	1.22	0.80	4.22
430312U	74	120	7.5	2.5	1	59.5	0.35	1.96	2.91	1.91	4.31
432312U	74	120	11.5	2.5	1	71	0.35	1.96	2.91	1.91	6.29
4T-430213X	75	113	4.5	2	0.6	53.5	0.40	1.67	2.48	1.63	2.49
432213U	75	115	5.5	2	0.6	61.5	0.40	1.67	2.48	1.63	3.33
4T-430313DX	79	133	13	2.5	1	94.5	0.83	0.82	1.22	0.80	5.16
430313XU	79	130	8	2.5	1	64	0.35	1.96	2.91	1.91	5.32
432313U	79	130	12	2.5	1	74.5	0.35	1.96	2.91	1.91	7.55
4T-430214	80	118	5	2	0.6	57	0.42	1.61	2.39	1.57	2.67
432214U	80	119	6	2	0.6	64.5	0.42	1.61	2.39	1.57	3.56
4T-430314DX	84	142	13	2.5	1	101	0.83	0.82	1.22	0.80	6.23
430314XU	84	140	8	2.5	1	67	0.35	1.96	2.91	1.91	6.37
432314U	84	140	12	2.5	1	80.5	0.35	1.96	2.91	1.91	9.28

● Double Row Tapered Roller Bearings

Back-to-back arrangement

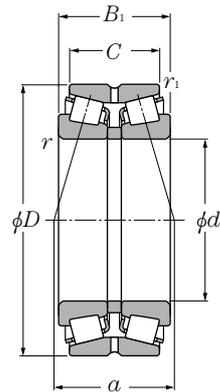

d 75 ~ 105mm

d	Boundary dimensions					dynamic kN	Basic load ratings			Limiting speeds	
	D	B ₁	C	r _s min ¹⁾	r _{1s} min ¹⁾		static kN	dynamic kgf	static kgf	grease min ⁻¹	oil min ⁻¹
75	130	62	51.5	2	0.6	238	350	24 300	36 000	2 300	3 000
	130	74	61.5	2	0.6	288	445	29 300	45 500	2 300	3 000
	160	87	59	3	1	370	510	37 500	52 000	1 700	2 300
	160	87	69	3	1	435	605	44 500	62 000	2 000	2 700
	160	125	99	3	1	610	935	62 000	95 500	2 000	2 700
80	140	64	51.5	2.5	0.6	274	400	27 900	40 500	2 100	2 800
	140	78	63.5	2.5	0.6	340	530	35 000	54 000	2 100	2 800
	170	92	61	3	1	405	565	41 500	58 000	1 600	2 200
	170	92	73	3	1	500	700	51 000	71 500	1 900	2 500
	170	131	104	3	1	680	1 050	69 000	107 000	1 900	2 500
85	150	70	57	2.5	0.6	315	465	32 000	47 000	2 000	2 700
	150	86	69	2.5	0.6	385	600	39 000	61 500	2 000	2 700
	180	98	65	4	1	425	585	43 000	59 500	1 500	2 100
	180	98	77	4	1	520	725	53 000	74 000	1 800	2 400
	180	137	108	4	1	690	1 050	70 500	107 000	1 800	2 400
90	160	74	61	2.5	0.6	355	535	36 500	54 500	1 900	2 500
	160	94	77	2.5	0.6	450	720	46 000	73 500	1 900	2 500
	190	102	69	4	1	465	645	47 500	65 500	1 500	1 900
	190	102	81	4	1	580	815	59 000	83 000	1 700	2 300
	190	144	115	4	1	770	1 190	78 500	121 000	1 700	2 300
95	170	78	63	3	1	385	580	39 500	59 000	1 800	2 400
	170	100	83	3	1	515	835	52 500	85 000	1 800	2 400
	200	108	85	4	1	630	890	64 000	91 000	1 600	2 100
	200	108	85	3	1	540	735	55 500	75 000	1 600	2 100
	200	151	118	4	1	865	1 340	88 000	137 000	1 600	2 100
100	180	83	67	3	1	440	675	45 000	68 500	1 700	2 200
	180	107	87	3	1	565	925	58 000	94 500	1 700	2 200
	215	112	87	4	1	700	995	71 500	102 000	1 500	2 000
	215	112	87	3	1	590	800	60 000	81 500	1 500	2 000
	215	162	127	4	1	980	1 540	100 000	157 000	1 500	2 000
105	190	88	70	3	1	490	760	50 000	77 500	1 600	2 100
	190	115	95	3	1	650	1 080	66 000	111 000	1 600	2 100
	225	116	91	3	1	625	845	63 500	86 000	1 400	1 900

1) Minimum allowable dimension for chamfer dimension r or r₁.

Note: 1. When incorporating bearings with bearing numbers marked with " * ", please consult NTN Engineering.

● Double Row Tapered Roller Bearings

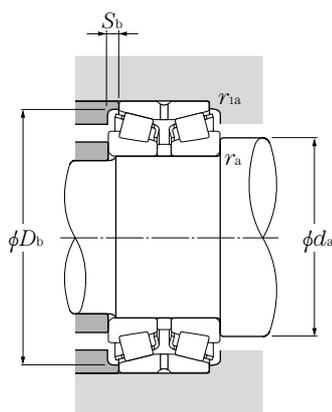

Equivalent radial load dynamic

$$P_r = XF_r + YF_a$$

$\frac{F_a}{F_r} \leq e$		$\frac{F_a}{F_r} > e$	
X	Y	X	Y
1	Y ₁	0.67	Y ₂

static

$$P_{or} = F_r + Y_o F_a$$

For values of e , Y_2 and Y_o see the table below.

Bearing numbers	Abutment and fillet dimensions					Load center mm <i>a</i>	Constant <i>e</i>	Axial load factors			Mass kg (approx.)
	<i>d_a</i> min	<i>D_b</i> min	<i>S_b</i> min	<i>r_{as}</i> max	<i>r_{1as}</i> max			<i>Y₁</i>	<i>Y₂</i>	<i>Y_o</i>	
4T-430215	85	124	5	2	0.6	61.5	0.44	1.55	2.31	1.52	2.99
432215U	85	125	6	2	0.6	67	0.44	1.55	2.31	1.52	3.68
430315DU	89	151	14	2.5	1	107	0.83	0.82	1.22	0.80	7.31
430315XU	89	149	9	2.5	1	70.5	0.35	1.96	2.91	1.91	7.71
432315U	89	149	13	2.5	1	87.5	0.35	1.96	2.91	1.91	11.5
430216XU	92	132	6	2	0.6	63	0.42	1.61	2.39	1.57	3.65
432216XU	92	134	7	2	0.6	69.5	0.42	1.61	2.39	1.57	4.58
430316DU	94	159	15.5	2.5	1	114	0.83	0.82	1.22	0.80	8.99
430316XU	94	159	9.5	2.5	1	75.5	0.35	1.96	2.91	1.91	9.55
432316U	94	159	13.5	2.5	1	90.5	0.35	1.96	2.91	1.91	13.6
430217XU	97	141	6.5	2	0.6	69	0.42	1.61	2.39	1.57	4.59
432217XU	97	142	8.5	2	0.6	76	0.42	1.61	2.39	1.57	5.85
430317DU	103	169	16.5	3	1	121	0.83	0.82	1.22	0.80	10.6
430317XU	103	167	10.5	3	1	80	0.35	1.96	2.91	1.91	11.2
432317U	103	167	14.5	3	1	96	0.35	1.96	2.91	1.91	15.4
430218U	102	150	6.5	2	0.6	73	0.42	1.61	2.39	1.57	5.66
432218U	102	152	8.5	2	0.6	81	0.42	1.61	2.39	1.57	7.35
430318DU	108	180	16.5	3	1	127	0.83	0.82	1.22	0.80	12.5
430318U	108	177	10.5	3	1	84	0.35	1.96	2.91	1.91	12.9
432318U	108	177	14.5	3	1	100	0.35	1.96	2.91	1.91	18.2
430219XU	109	159	7.5	2.5	1	76.5	0.42	1.61	2.39	1.57	8.01
432219XU	109	161	8.5	2.5	1	86.5	0.42	1.61	2.39	1.57	9.04
* 430319XU	113	186	11.5	3	1	89	0.35	1.96	2.91	1.91	15.0
430319X	113	186	11.5	3	1	88.5	0.35	1.95	2.90	1.91	14.0
432319U	113	186	16.5	3	1	106	0.35	1.96	2.91	1.91	21.5
430220XU	114	168	8	2.5	1	81.5	0.42	1.61	2.39	1.57	8.11
432220XU	114	171	10	2.5	1	92	0.42	1.61	2.39	1.57	10.7
* 430320XU	118	200	12.5	3	1	92	0.35	1.96	2.91	1.91	18.4
430320X	118	200	12.5	3	1	93.5	0.35	1.95	2.90	1.91	16.5
432320U	118	200	17.5	3	1	113	0.35	1.96	2.91	1.91	26.5
430221XU	119	178	9	2.5	1	86	0.42	1.61	2.39	1.57	9.73
432221XU	119	180	10	2.5	1	97.5	0.42	1.61	2.39	1.57	13.1
430321X	123	209	12.5	3	1	96.5	0.35	1.95	2.90	1.91	19.6

Double Row Tapered Roller Bearings

Back-to-back arrangement

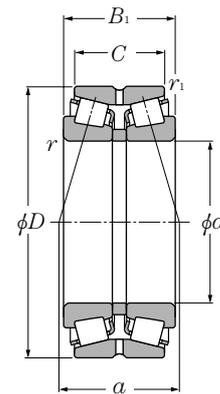

d 105 ~ 140mm

d	Boundary dimensions					dynamic kN	Basic load ratings			Limiting speeds	
	D	B ₁	C	r _s min ¹⁾	r _{1s} min ¹⁾		static kN	dynamic kgf	static kgf	grease min ⁻¹	oil min ⁻¹
105	225	116	91	4	1	750	1 060	76 000	109 000	1 400	1 900
	225	170	133	3	1	955	1 470	97 500	150 000	1 400	1 900
110	180	56	50	2.5	0.6	228	340	23 300	35 000	1 600	2 200
	180	70	56	2.5	0.6	298	485	30 500	49 500	1 600	2 200
	200	92	74	3	1	555	865	56 500	88 500	1 500	2 000
	200	121	101	3	1	720	1 210	73 500	124 000	1 500	2 000
	240	118	93	4	1	825	1 180	84 000	120 000	1 400	1 800
	240	118	93	3	1	685	925	69 500	94 500	1 400	1 800
	240	181	142	3	1	1 070	1 660	109 000	169 000	1 400	1 800
240	181	142	4	1	1 210	1 940	123 000	197 000	1 400	1 800	
120	180	46	41	2.5	0.6	193	298	19 700	30 500	1 500	2 100
	180	58	46	2.5	0.6	230	375	23 500	38 000	1 500	2 100
	200	62	55	2.5	0.6	263	435	26 800	44 500	1 500	2 000
	200	78	62	2.5	0.6	370	610	38 000	62 500	1 500	2 000
	215	97	78	3	1	595	940	60 500	96 000	1 400	1 900
	215	132	109	3	1	790	1 360	80 500	139 000	1 400	1 900
	260	128	101	4	1	960	1 390	97 500	142 000	1 200	1 700
	260	128	101	3	1	800	1 100	81 500	112 000	1 200	1 700
260	188	145	4	1	1 400	2 270	143 000	231 000	1 200	1 700	
130	200	52	46	2.5	0.6	224	365	22 900	37 500	1 400	1 900
	200	65	52	2.5	0.6	294	490	29 900	50 000	1 400	1 900
	210	64	57	2.5	0.6	315	485	32 000	49 500	1 400	1 800
	210	80	64	2.5	0.6	410	675	42 000	69 000	1 400	1 800
	230	98	78.5	4	1	640	1 010	65 500	103 000	1 300	1 700
	230	145	117.5	4	1	905	1 630	92 500	166 000	1 300	1 700
280	137	107.5	5	1.5	1 110	1 660	113 000	169 000	1 200	1 500	
140	210	53	47	2.5	0.6	262	415	26 700	42 500	1 300	1 800
	210	66	53	2.5	0.6	300	535	30 500	54 500	1 300	1 800
	225	68	61	3	1	370	580	37 500	59 500	1 200	1 700
	225	84	68	3	1	390	650	40 000	66 000	1 200	1 700
	250	102	82.5	3	1	640	970	65 500	99 000	1 200	1 600
	250	102	82.5	4	1	720	1 140	73 500	117 000	1 200	1 600
	250	153	125.5	4	1	1 050	1 840	107 000	188 000	1 200	1 600
	300	145	115.5	5	1.5	1 260	1 900	129 000	194 000	1 100	1 400
	300	145	115.5	4	1.5	1 100	1 560	112 000	160 000	1 100	1 400

1) Minimum allowable dimension for chamfer dimension r or r₁.

Note: 1. When incorporating bearings with bearing numbers marked with " * ", please consult NTN Engineering.

● Double Row Tapered Roller Bearings

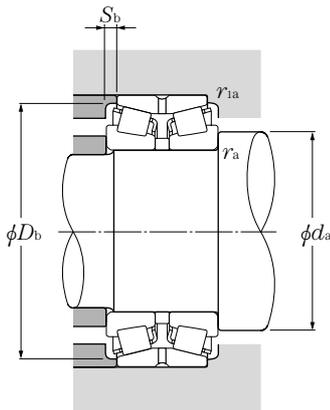

Equivalent radial load
dynamic

$$P_r = XF_r + YF_a$$

$\frac{F_a}{F_r} \leq e$		$\frac{F_a}{F_r} > e$	
X	Y	X	Y
1	Y ₁	0.67	Y ₂

static

$$P_{or} = F_r + Y_0 F_a$$

For values of e , Y_2 and Y_0 see the table below.

Bearing numbers	Abutment and fillet dimensions					Load center mm <i>a</i>	Constant <i>e</i>	Axial load factors			Mass kg (approx.)
	<i>d_a</i> min	<i>D_b</i> min	<i>S_b</i> min	<i>r_{as}</i> max	<i>r_{1as}</i> max			<i>Y₁</i>	<i>Y₂</i>	<i>Y₀</i>	
* 430321XU 432321	123 119	209 208	12.5 18.5	3 2.5	1 1	96.5 117.5	0.35 0.35	1.96 1.96	2.91 2.90	1.91 1.91	21.0 30.2
413122	122	169	3	2	0.6	66.5	0.40	1.68	2.50	1.64	5.20
423122	122	166	7	2	0.6	66.5	0.33	2.03	3.02	1.98	6.38
430222XU	124	188	9	2.5	1	90	0.42	1.61	2.39	1.57	11.4
432222XU	124	190	10	2.5	1	102	0.42	1.61	2.39	1.57	15.5
* 430322U	128	222	12.5	3	1	100	0.35	1.96	2.91	1.91	24.5
430322	128	222	12.5	3	1	97.5	0.35	1.95	2.90	1.91	22.1
432322	128	222	19.5	3	1	124	0.35	1.95	2.90	1.91	35.6
* 432322U	128	222	19.5	3	1	127	0.35	1.96	2.91	1.91	38.2
413024	132	171	2.5	2	0.6	59	0.37	1.80	2.69	1.76	3.85
423024	132	170	6	2	0.6	66	0.37	1.80	2.69	1.76	4.41
413124	132	184	3.5	2	0.6	76.5	0.43	1.57	2.34	1.53	7.24
423124	132	188	8	2	0.6	76.5	0.37	1.80	2.69	1.76	8.96
430224XU	134	203	9.5	2.5	1	98	0.44	1.55	2.31	1.52	13.6
432224XU	134	204	11.5	2.5	1	112	0.44	1.55	2.31	1.52	18.9
430324XU	138	239	13.5	3	1	107	0.35	1.96	2.91	1.91	30.5
430324X	138	239	13.5	3	1	106	0.35	1.95	2.90	1.91	29.4
432324U	138	239	21.5	3	1	130	0.35	1.96	2.91	1.91	47.0
413026	142	186	3	2	0.6	66	0.37	1.80	2.69	1.76	5.55
423026	142	189	6.5	2	0.6	71.5	0.37	1.80	2.69	1.76	6.62
413126	142	196	3.5	2	0.6	69	0.33	2.03	3.02	1.98	7.83
423126	142	198	8	2	0.6	79.5	0.37	1.80	2.69	1.76	9.77
430226XU	148	218	9.5	3	1	102	0.44	1.55	2.31	1.52	15.9
432226XU	148	219	13.5	3	1	124	0.44	1.55	2.31	1.52	24.1
430326XU	152	255	14.5	4	1.5	116	0.35	1.96	2.91	1.91	37.9
413028	152	199	3	2	0.6	68.5	0.37	1.80	2.69	1.76	5.88
423028	152	197	6.5	2	0.6	75	0.37	1.84	2.74	1.80	7.11
413128	154	210	3.5	2.5	1	73.5	0.33	2.03	3.02	1.98	9.18
423128	154	209	8	2.5	1	88	0.37	1.80	2.69	1.76	11.8
430228X	158	237	9.5	3	1	106	0.43	1.57	2.34	1.53	18.0
* 430228XU	158	237	9.5	3	1	107	0.44	1.55	2.31	1.52	19.9
432228XU	158	238	13.5	3	1	131	0.44	1.55	2.31	1.52	30.1
* 430328XU	162	273	14.5	4	1.5	123	0.35	1.96	2.91	1.91	46.6
430328X	162	272	14.5	4	1.5	123	0.35	1.95	2.90	1.91	44.4

Double Row Tapered Roller Bearings

Back-to-back arrangement

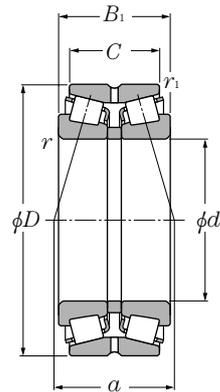

d 150 ~ 190mm

d	Boundary dimensions					dynamic kN	Basic load ratings			Limiting speeds	
	D	B ₁	C	r _{s min} ¹⁾	r _{1s min} ¹⁾		static kN	dynamic kgf	static kgf	grease	oil
150	225	56	50	3	1	274	430	27 900	44 000	1 200	1 600
	225	70	56	3	1	355	630	36 000	64 500	1 200	1 600
	250	80	71	3	1	485	805	49 500	82 000	1 200	1 500
	250	100	80	3	1	600	1 040	61 500	106 000	1 200	1 500
	270	109	87	4	1	770	1 210	78 500	123 000	1 100	1 500
	270	164	130	4	1	1 200	2 140	122 000	218 000	1 100	1 500
	320	154	120	5	1.5	1 410	2 140	144 000	218 000	990	1 300
320	154	120	4	1.5	1 170	1 750	119 000	178 000	990	1 300	
160	240	60	53	3	1	330	535	34 000	54 500	1 100	1 500
	240	75	60	3	1	430	765	44 000	78 000	1 100	1 500
	270	86	76	3	1	595	965	60 500	98 000	1 100	1 400
	270	108	86	3	1	675	1 180	69 000	120 000	1 100	1 400
	290	115	91	4	1	900	1 440	92 000	147 000	1 000	1 400
	290	178	144	4	1	1 530	2 840	156 000	290 000	1 000	1 400
	340	160	126	5	1.5	1 570	2 390	160 000	244 000	920	1 200
340	160	126	4	1.5	1 290	1 950	132 000	199 000	920	1 200	
170	260	67	60	3	1	365	620	37 000	63 500	1 100	1 400
	260	84	67	3	1	490	865	50 000	88 000	1 100	1 400
	280	88	78	3	1	550	900	56 000	92 000	1 000	1 300
	280	110	88	3	1	725	1 270	74 000	130 000	1 000	1 300
	310	125	97	5	1.5	1 050	1 690	107 000	173 000	950	1 300
310	192	152	5	1.5	1 710	3 200	174 000	325 000	950	1 300	
180	280	74	66	3	1	425	735	43 000	75 000	1 000	1 300
	280	93	74	3	1	580	1 050	59 500	107 000	1 000	1 300
	300	96	85	4	1.5	705	1 190	72 000	121 000	940	1 300
	300	120	96	4	1.5	885	1 530	90 500	156 000	940	1 300
	320	127	99	5	1.5	1 080	1 780	110 000	182 000	890	1 200
	320	192	152	5	1.5	1 760	3 350	180 000	345 000	890	1 200
190	290	75	67	3	1	430	740	44 000	75 500	940	1 300
	290	94	75	3	1	615	1 110	63 000	113 000	940	1 300
	320	104	92	4	1.5	780	1 280	79 500	131 000	890	1 200
	320	130	104	4	1.5	985	1 710	100 000	174 000	890	1 200
	340	133	105	5	1.5	1 230	2 010	125 000	205 000	840	1 100
	340	204	160	5	1.5	1 970	3 700	201 000	380 000	840	1 100
	340	204	160	4	1.5	1 710	3 350	175 000	340 000	840	1 100

1) Minimum allowable dimension for chamfer dimension r or r₁.

Note: 1. When incorporating bearings with bearing numbers marked with " * ", please consult NTN Engineering.

Double Row Tapered Roller Bearings

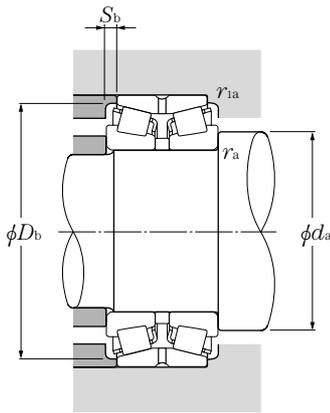

Equivalent radial load
dynamic

$$P_r = XF_r + YF_a$$

$\frac{F_a}{F_r} \leq e$		$\frac{F_a}{F_r} > e$	
X	Y	X	Y
1	Y ₁	0.67	Y ₂

static

$$P_{or} = F_r + Y_0 F_a$$

For values of e , Y_2 and Y_0 see the table below.

Bearing numbers	Abutment and fillet dimensions					Load center mm <i>a</i>	Constant <i>e</i>	Axial load factors			Mass kg (approx.)
	<i>d_a</i> min	<i>D_b</i> min	<i>S_b</i> min	<i>r_{as}</i> max	<i>r_{1as}</i> max			<i>Y₁</i>	<i>Y₂</i>	<i>Y₀</i>	
* 413030	164	213	3	2.5	1	73.5	0.37	1.80	2.69	1.76	6.66
423030	164	212	7	2.5	1	79.5	0.37	1.80	2.69	1.76	8.76
413130	164	231	4.5	2.5	1	82.5	0.33	2.03	3.02	1.98	14.3
423130	164	234	10	2.5	1	96.5	0.37	1.80	2.69	1.76	18.0
430230U	168	255	11	3	1	114	0.44	1.55	2.31	1.52	24.4
432230XU	168	254	17	3	1	139	0.44	1.55	2.31	1.52	37.3
* 430330U	172	292	17	4	1.5	132	0.35	1.96	2.91	1.91	55.4
430330	172	292	17	4	1.5	135	0.37	1.80	2.69	1.76	52.8
413032	174	227	3.5	2.5	1	79	0.37	1.80	2.69	1.76	8.29
423032	174	227	7.5	2.5	1	85.5	0.37	1.80	2.69	1.76	10.7
413132E1	174	254	5	2.5	1	98.5	0.40	1.68	2.50	1.64	18.2
423132E1	174	250	11	2.5	1	106	0.37	1.80	2.69	1.76	22.8
430232U	178	272	12	3	1	122	0.44	1.55	2.31	1.52	31.9
432232U	178	275	17	3	1	150	0.44	1.55	2.31	1.52	46.9
* 430332XU	182	310	17	4	1.5	138	0.35	1.96	2.91	1.91	65.5
430332X	182	311	17	4	1.5	141	0.37	1.80	2.69	1.76	62.4
413034	184	242	3.5	2.5	1	86.5	0.37	1.80	2.69	1.76	11.6
423034	184	244	8.5	2.5	1	93.5	0.37	1.80	2.69	1.76	14.3
413134E1	184	260	5	2.5	1	104	0.40	1.68	2.50	1.64	19.5
423134E1	184	260	11	2.5	1	109	0.37	1.80	2.69	1.76	24.7
430234U	192	288	14	4	1.5	132	0.44	1.55	2.31	1.52	38.0
432234XU	192	293	20	4	1.5	160	0.44	1.55	2.31	1.52	58.2
413036E1	194	260	4	2.5	1	94	0.37	1.80	2.69	1.76	15.9
423036E1	194	262	9.5	2.5	1	102	0.37	1.80	2.69	1.76	19.0
413136E1	198	280	5.5	3	1.5	111	0.40	1.68	2.50	1.64	24.6
423136E1	198	279	12	3	1.5	119	0.37	1.80	2.69	1.76	31.4
430236U	202	297	14	4	1.5	139	0.45	1.50	2.23	1.47	39.4
432236U	202	305	20	4	1.5	165	0.45	1.50	2.23	1.47	60.6
413038E1	204	271	4	2.5	1	96	0.37	1.80	2.69	1.76	16.2
423038E1	204	272	9.5	2.5	1	104	0.37	1.80	2.69	1.76	19.6
413138	208	300	6	3	1.5	119	0.40	1.68	2.50	1.64	30.8
423138	208	299	13	3	1.5	126	0.37	1.80	2.69	1.76	38.6
430238U	212	316	14	4	1.5	141	0.44	1.55	2.31	1.52	45.4
* 432238U	212	323	22	4	1.5	174	0.44	1.55	2.31	1.52	73.3
432238	212	323	22	4	1.5	185	0.49	1.38	2.06	1.35	69.8

● Double Row Tapered Roller Bearings

Back-to-back arrangement

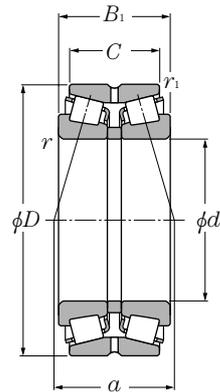

d 200 ~ 340mm

d	Boundary dimensions					dynamic kN	Basic load ratings			Limiting speeds	
	D	B ₁	C	r _{s min} ¹⁾	r _{1s min} ¹⁾		static kN	dynamic kgf	static kgf	grease min ⁻¹	oil min ⁻¹
200	310	82	73	3	1	530	940	54 000	96 000	900	1 200
	310	103	82	3	1	720	1 320	73 000	135 000	900	1 200
	340	112	100	4	1.5	965	1 660	98 500	169 000	840	1 100
	340	140	112	4	1.5	1 090	1 910	111 000	195 000	840	1 100
	360	142	110	5	1.5	1 350	2 210	137 000	226 000	800	1 100
	360	218	174	5	1.5	2 260	4 250	230 000	435 000	800	1 100
220	360	218	174	4	1.5	1 980	3 950	201 000	400 000	800	1 100
	340	90	80	4	1.5	595	1 060	61 000	108 000	810	1 100
	340	113	90	4	1.5	880	1 650	89 500	168 000	810	1 100
	370	120	107	5	1.5	1 110	1 920	113 000	196 000	760	1 000
240	370	150	120	5	1.5	1 220	2 260	125 000	230 000	760	1 000
	360	92	82	4	1.5	655	1 160	66 500	118 000	730	980
	360	115	92	4	1.5	910	1 770	92 500	181 000	730	980
	400	128	114	5	1.5	1 230	2 130	126 000	217 000	690	920
260	400	160	128	5	1.5	1 400	2 600	142 000	265 000	690	920
	400	104	92	5	1.5	840	1 540	85 500	157 000	670	900
	400	130	104	5	1.5	1 150	2 190	117 000	223 000	670	900
	440	144	128	5	1.5	1 500	2 630	152 000	268 000	630	840
280	440	180	144	5	1.5	1 940	3 750	198 000	380 000	630	840
	420	106	94	5	1.5	890	1 630	91 000	166 000	620	820
	420	133	106	5	1.5	1 200	2 340	123 000	238 000	620	820
	460	146	130	6	2	1 640	2 900	167 000	296 000	580	770
300	460	183	146	6	2	1 960	3 650	200 000	375 000	580	770
	460	118	105	5	1.5	1 070	1 990	109 000	203 000	570	760
	460	148	118	5	1.5	1 610	3 150	165 000	320 000	570	760
	500	160	142	6	2	2 010	3 600	205 000	370 000	530	710
320	500	200	160	6	2	2 100	4 050	214 000	415 000	530	710
	480	121	108	5	1.5	1 190	2 250	121 000	229 000	530	710
	480	151	121	5	1.5	1 580	3 100	162 000	315 000	530	710
	540	176	157	6	2	2 240	4 100	228 000	415 000	500	660
340	540	220	176	6	2	2 500	4 900	255 000	500 000	500	660
	520	133	118	6	2	1 480	2 870	150 000	293 000	500	660

1) Minimum allowable dimension for chamfer dimension r or r₁.

Note: 1. When incorporating bearings with bearing numbers marked with " * ", please consult NTN Engineering.

● Double Row Tapered Roller Bearings

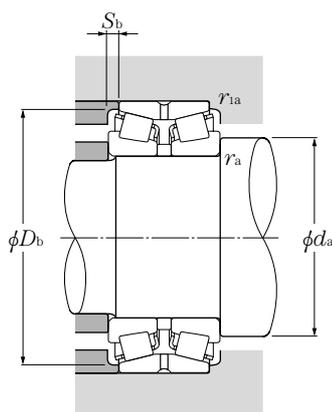

Equivalent radial load

$P_r = XF_r + YF_a$

$\frac{F_a}{F_r} \leq e$		$\frac{F_a}{F_r} > e$	
X	Y	X	Y
1	Y ₁	0.67	Y ₂

static

$P_{or} = F_r + Y_0 F_a$

For values of e , Y_2 and Y_0 see the table below.

Bearing numbers	Abutment and fillet dimensions					Load center mm <i>a</i>	Constant <i>e</i>	Axial load factors			Mass kg (approx.)
	<i>d_a</i> min	<i>D_b</i> min	<i>S_b</i> min	<i>r_{as}</i> max	<i>r_{1as}</i> max			<i>Y₁</i>	<i>Y₂</i>	<i>Y₀</i>	
413040E1	214	288	4.5	2.5	1	101	0.37	1.80	2.69	1.76	20.6
423040E1	214	291	10.5	2.5	1	112	0.37	1.80	2.69	1.76	25.7
413140	218	320	6	3	1.5	125	0.40	1.68	2.50	1.64	38.6
423140	218	316	14	3	1.5	134	0.37	1.80	2.69	1.76	47.5
430240U	222	336	16	4	1.5	154	0.44	1.55	2.31	1.52	62.8
* 432240U	222	340	22	4	1.5	180	0.41	1.66	2.47	1.62	95.2
432240	222	340	22	4	1.5	193	0.49	1.38	2.06	1.35	90.7
413044E1	238	318	5	3	1.5	112	0.37	1.80	2.69	1.76	26.7
423044E1	238	319	11.5	3	1.5	125	0.37	1.80	2.69	1.76	33.3
413144	242	346	6.5	4	1.5	135	0.40	1.68	2.50	1.64	47.8
423144	242	341	15	4	1.5	154	0.40	1.68	2.50	1.64	59.6
413048E1	258	339	5	3	1.5	117	0.37	1.80	2.69	1.76	30.2
423048E1	258	340.5	11.5	3	1.5	131	0.37	1.80	2.69	1.76	36.3
413148	262	375	7	4	1.5	144	0.40	1.68	2.50	1.64	58.9
423148	262	373	16	4	1.5	164	0.40	1.68	2.50	1.64	71.7
413052	282	372	6	4	1.5	131	0.37	1.80	2.69	1.76	41.5
423052	282	374	13	4	1.5	143	0.37	1.80	2.69	1.76	53.0
413152	282	412	8	4	1.5	161	0.40	1.68	2.50	1.64	82.2
423152	282	413	18	4	1.5	176	0.40	1.68	2.50	1.64	101
413056	302	394	6	4	1.5	136	0.37	1.80	2.69	1.76	47.2
423056	302	397	13.5	4	1.5	148	0.37	1.80	2.69	1.76	57.3
413156	308	435	8	5	2	168	0.40	1.68	2.50	1.64	87.4
423156	308	433	18.5	5	2	177	0.40	1.68	2.50	1.64	109
413060	322	428	6.5	4	1.5	151	0.37	1.80	2.69	1.76	65.6
423060	322	434	15	4	1.5	163	0.37	1.80	2.69	1.76	80.2
413160	328	471	9	5	2	182	0.40	1.68	2.50	1.64	115
423160	328	464	20	5	2	202	0.40	1.68	2.50	1.64	144
413064	342	449	6.5	4	1.5	157	0.37	1.80	2.69	1.76	70.9
423064	342	455	15	4	1.5	170	0.37	1.80	2.69	1.76	85.4
413164	348	505	9.5	5	2	197	0.40	1.68	2.50	1.64	150
423164	348	502	22	5	2	217	0.40	1.68	2.50	1.64	188
413068	368	488	7.5	5	2	170	0.37	1.8	2.69	1.76	89.2

Double Row Tapered Roller Bearings

Back-to-back arrangement

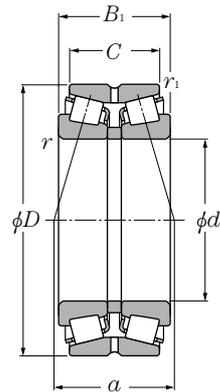

d 340 ~ 480mm

d	Boundary dimensions					Basic load ratings				Limiting speeds	
	D	B ₁	C	r _{s min} ¹⁾	r _{1s min} ¹⁾	dynamic kN	static kN	dynamic kgf	static kgf	grease min ⁻¹	oil min ⁻¹
340	520	165	133	6	2	1 890	3 750	193 000	380 000	500	660
	580	190	169	6	2	2 690	4 900	274 000	500 000	460	620
	580	238	190	6	2	3 350	6 500	345 000	660 000	460	620
360	540	134	120	6	2	1 470	2 810	150 000	287 000	460	620
	540	169	134	6	2	2 050	4 200	209 000	430 000	460	620
	600	192	171	6	2	2 720	5 050	277 000	515 000	430	580
	600	240	192	6	2	3 200	6 500	325 000	660 000	430	580
380	560	135	122	6	2	1 690	3 350	172 000	340 000	440	580
	560	171	135	6	2	2 080	4 350	213 000	445 000	440	580
	620	194	173	6	2	2 840	5 250	289 000	535 000	410	540
	620	243	194	6	2	3 350	6 700	340 000	685 000	410	540
400	600	148	132	6	2	1 860	3 700	190 000	375 000	410	550
	600	185	148	6	2	2 530	5 450	258 000	555 000	410	550
	650	200	178	6	3	3 000	5 800	305 000	590 000	380	510
	650	250	200	6	3	3 750	7 850	385 000	800 000	380	510
420	620	150	134	6	2	2 110	4 250	215 000	435 000	390	520
	620	188	150	6	2	2 650	5 900	270 000	600 000	390	520
	700	224	200	6	3	3 700	7 200	375 000	735 000	360	480
	700	280	224	6	3	4 800	9 700	490 000	990 000	360	480
440	650	157	140	6	3	2 470	5 150	252 000	525 000	370	490
	650	196	157	6	3	2 600	5 450	266 000	560 000	370	490
	720	226	201	6	3	4 000	7 800	410 000	795 000	340	460
	720	283	226	6	3	5 000	10 300	510 000	1 050 000	340	460
460	680	163	145	6	3	2 600	5 350	265 000	550 000	350	470
	680	204	163	6	3	3 050	6 600	310 000	670 000	350	470
	760	240	214	7.5	4	4 550	9 150	465 000	930 000	320	430
	760	300	240	7.5	4	4 900	10 300	500 000	1 050 000	320	430
480	700	165	147	6	3	2 490	5 000	254 000	510 000	330	450
	700	206	165	6	3	3 050	6 700	310 000	685 000	330	450
	790	248	221	7.5	4	4 800	9 600	490 000	975 000	310	410
	790	310	248	7.5	4	5 300	11 100	540 000	1 130 000	310	410

1) Minimum allowable dimension for chamfer dimension r or r₁.

● Double Row Tapered Roller Bearings

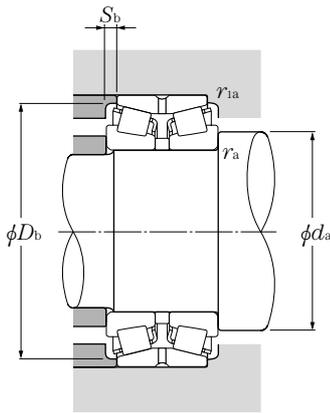

Equivalent radial load
dynamic

$$P_r = XF_r + YF_a$$

$\frac{F_a}{F_r} \leq e$		$\frac{F_a}{F_r} > e$	
X	Y	X	Y
1	Y ₁	0.67	Y ₂

static

$$P_{or} = F_r + Y_0 F_a$$

For values of e , Y_2 and Y_0 see the table below.

Bearing numbers	Abutment and fillet dimensions					Load center mm <i>a</i>	Constant <i>e</i>	Axial load factors			Mass kg (approx.)
	<i>d_a</i> min	<i>D_b</i> min	<i>S_b</i> min	<i>r_{as}</i> max	<i>r_{1as}</i> max			<i>Y₁</i>	<i>Y₂</i>	<i>Y₀</i>	
423068	368	489	16	5	2	184	0.37	1.80	2.69	1.76	113
413168	368	548	10.5	5	2	213	0.40	1.68	2.50	1.64	188
423168	368	542	24	5	2	237	0.40	1.68	2.50	1.64	235
413072	388	507	7	5	2	176	0.37	1.80	2.69	1.76	92.7
423072	388	509	17.5	5	2	192	0.37	1.80	2.69	1.76	120
413172	388	561	10.5	5	2	219	0.40	1.68	2.50	1.64	199
423172	388	560	24	5	2	240	0.40	1.68	2.50	1.64	248
413076	408	528	6.5	5	2	183	0.37	1.80	2.69	1.76	95.9
423076	408	529	18	5	2	196	0.37	1.80	2.69	1.76	126
413176	408	583	10.5	5	2	225	0.40	1.68	2.50	1.64	210
423176	408	578	24.5	5	2	249	0.40	1.68	2.50	1.64	262
413080	428	564	8	5	2	194	0.37	1.80	2.69	1.76	105
423080	428	564	18.5	5	2	210	0.37	1.80	2.69	1.76	163
413180	428	610	11	5	2.5	232	0.40	1.68	2.50	1.64	236
423180	428	610	25	5	2.5	256	0.40	1.68	2.50	1.64	294
413084	448	586	8	5	2	200	0.37	1.80	2.69	1.76	135
423084	448	583	19	5	2	220	0.37	1.80	2.69	1.76	172
413184	448	655	12	5	2.5	258	0.40	1.68	2.50	1.64	317
423184	448	659	28	5	2.5	287	0.40	1.68	2.50	1.64	394
413088	468	614	8.5	5	2.5	208	0.37	1.80	2.69	1.76	160
423088	468	614	19.5	5	2.5	229	0.37	1.80	2.69	1.76	198
413188	468	675	12.5	5	2.5	263	0.40	1.68	2.50	1.64	330
423188	468	678	28.5	5	2.5	288	0.40	1.68	2.50	1.64	412
413092	488	646	9	5	2.5	217	0.37	1.80	2.69	1.76	179
423092	488	644	20.5	5	2.5	239	0.37	1.80	2.69	1.76	225
413192	496	714	13	6	3	276	0.40	1.68	2.50	1.64	395
423192	496	712	30	6	3	305	0.40	1.68	2.50	1.64	493
413096	508	665	9	5	2.5	223	0.37	1.80	2.69	1.76	189
423096	508	664	20.5	5	2.5	246	0.37	1.80	2.69	1.76	236
413196	516	743	13.5	6	3	281	0.40	1.68	2.50	1.64	442
423196	516	738	31	6	3	329	0.40	1.68	2.50	1.64	548

● Double Row Tapered Roller Bearings

Back-to-back arrangement

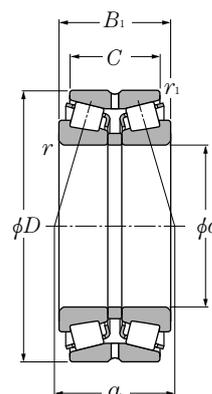

d 500mm

d	Boundary dimensions					Basic load ratings				Limiting speeds	
	D	B ₁	C	r _s min ¹⁾	r _{1s} min ¹⁾	dynamic kN	static kN	dynamic kgf	static kgf	grease min ⁻¹	oil min ⁻¹
500	720	167	149	6	3	2 610	5 400	266 000	550 000	320	420
	720	209	167	6	3	3 050	6 900	315 000	700 000	320	420
	830	264	235	7.5	4	5 200	10 500	530 000	1 070 000	290	390
	830	330	264	7.5	4	6 400	14 000	650 000	1 420 000	290	390



1) Minimum allowable dimension for chamfer dimension r or r₁.

● Double Row Tapered Roller Bearings

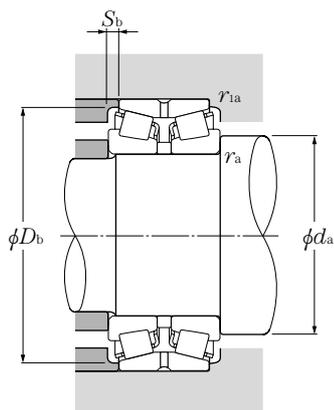

Equivalent radial load dynamic

$$P_r = XF_r + YF_a$$

$\frac{F_a}{F_r} \leq e$		$\frac{F_a}{F_r} > e$	
X	Y	X	Y
1	Y ₁	0.67	Y ₂

static

$$P_{or} = F_r + Y_0 F_a$$

For values of e , Y_2 and Y_0 see the table below.

Bearing numbers	Abutment and fillet dimensions					Load center mm	Constant e	Axial load factors			Mass kg (approx.)
	d_a min	D_b min	S_b min	r_{as} max	r_{1as} max			a	Y_1	Y_2	
4130/500	528	686	9	5	2.5	230	0.37	1.80	2.69	1.76	202
4230/500	528	683	21	5	2.5	250	0.37	1.80	2.69	1.76	247
4131/500	536	780	14.5	6	3	296	0.40	1.68	2.50	1.64	528
5E-4231/500G2	536	773	33	6	3	331	0.40	1.68	2.50	1.64	678



Double Row Tapered Roller Bearings

Face-to-face arrangement

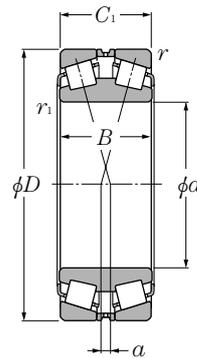

d 110 ~ 280mm

d	Boundary dimensions					dynamic kN	Basic load ratings			Limiting speeds	
	D	B	C ₁	r _{1s min} ¹⁾	r _{s min} ¹⁾		static	dynamic	static	grease	oil
	mm							kgf		min ⁻¹	
110	180	56	56	2.5	2	298	485	30 500	49 500	1 600	2 200
	180	46	46	2.5	2	230	375	23 500	38 000	1 500	2 100
120	200	62	62	2.5	2	370	610	38 000	62 500	1 500	2 000
	200	52	52	2.5	2	294	490	29 900	50 000	1 400	1 900
130	210	64	64	2.5	2	410	675	42 000	69 000	1 400	1 800
	210	53	53	2.5	2	300	535	30 500	54 500	1 300	1 800
140	225	68	68	3	2.5	390	650	40 000	66 000	1 200	1 700
	225	56	56	3	2.5	355	630	36 000	64 500	1 200	1 600
150	250	80	80	3	2.5	600	1 040	61 500	106 000	1 200	1 500
	240	60	60	3	2.5	430	765	44 000	78 000	1 100	1 500
160	270	86	86	3	2.5	675	1 180	69 000	120 000	1 100	1 400
	260	67	67	3	2.5	490	865	50 000	88 000	1 100	1 400
170	280	88	88	3	2.5	725	1 270	74 000	130 000	1 000	1 300
	280	74	74	3	2.5	580	1 050	59 500	107 000	1 000	1 300
180	300	96	96	4	3	885	1 530	90 500	156 000	940	1 300
	290	75	75	3	2.5	615	1 110	63 000	113 000	940	1 300
190	320	104	104	4	3	985	1 710	100 000	174 000	890	1 200
	310	82	82	3	2.5	720	1 320	73 000	135 000	900	1 200
200	340	112	112	4	3	1 090	1 910	111 000	195 000	840	1 100
	340	90	90	4	3	880	1 650	89 500	168 000	810	1 100
220	370	120	120	5	4	1 220	2 260	125 000	230 000	760	1 000
	360	92	92	4	3	910	1 770	92 500	181 000	730	980
240	400	128	128	5	4	1 400	2 600	142 000	265 000	690	920
	400	104	104	5	4	1 150	2 190	117 000	223 000	670	900
260	440	144	144	5	4	1 960	3 750	200 000	380 000	630	840
	440	106	106	5	4	1 200	2 340	123 000	238 000	620	820
280	420	106	106	5	4	1 200	2 340	123 000	238 000	620	820

1) Minimum allowable dimension for chamfer dimension r or r₁.

● Double Row Tapered Roller Bearings

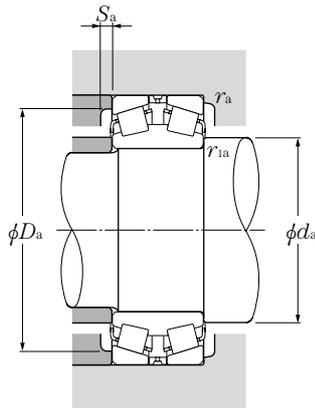

Equivalent radial load dynamic

$$P_r = XF_r + YF_a$$

$\frac{F_a}{F_r} \leq e$		$\frac{F_a}{F_r} > e$	
X	Y	X	Y
1	Y ₁	0.67	Y ₂

static

$$P_{or} = F_r + Y_0 F_a$$

For values of e , Y_2 and Y_0 see the table below.

Bearing numbers	Abutment and fillet dimensions						Load center mm	Constant e	Axial load factors			Mass kg (approx.)
	d_a max	D_a max	mm		r_{1as} max	r_{as} max			a	Y_1	Y_2	
323122	124	170	160	8	2	2	1	0.33	2.03	3.02	1.98	5.6
323024	134	170	164	8	2	2	12	0.37	1.80	2.69	1.76	4.08
323124	134	190	175	8	2	2	6.5	0.37	1.80	2.69	1.76	7.82
323026	144	190	184	8	2	2	13.5	0.37	1.80	2.69	1.76	5.92
323126	144	200	185	8	2	2	7.5	0.37	1.80	2.69	1.76	8.58
323028	155	200	190	8	2	2	10	0.37	1.84	2.74	1.80	6.4
323128	156	213	200	10	2.5	2	8	0.37	1.80	2.69	1.76	10.7
323030	165	213	205	10	2.5	2	15.5	0.37	1.80	2.69	1.76	7.76
323130	168	238	220	10	2.5	2	6.5	0.37	1.80	2.69	1.76	15.7
323032	175	228	215	10	2.5	2	17.5	0.37	1.80	2.69	1.76	9.46
323132E1	178	258	240	10	2.5	2	8	0.37	1.80	2.69	1.76	20
323034	185	248	235	10	2.5	2	18	0.37	1.80	2.69	1.76	12.8
323134E1	188	268	250	10	2.5	2	8.5	0.37	1.80	2.69	1.76	21.5
323036E1	198	268	250	10	2.5	2	17	0.37	1.80	2.69	1.76	16.5
323136E1	200	286	265	12	3	2.5	8	0.37	1.80	2.69	1.76	27.2
323038E1	208	278	260	12	2.5	2	17.5	0.37	1.80	2.69	1.76	17.9
323138	212	306	285	12	3	2.5	8.5	0.37	1.80	2.69	1.76	34
323040E1	218	298	280	12	2.5	2	19	0.37	1.80	2.69	1.76	21.7
323140	222	326	300	12	3	2.5	8.5	0.37	1.80	2.69	1.76	41.7
323044E1	242	326	310	12	3	2.5	21.5	0.37	1.80	2.69	1.76	29.8
323144	248	352	325	14	4	3	14	0.40	1.68	2.50	1.64	52.2
323048E1	269	346	321.5	14	3	2.5	25.5	0.37	1.80	2.69	1.76	32.6
323148	268	382	355	14	4	3	17	0.40	1.68	2.50	1.64	64.6
323052	285	382	365	14	4	3	25	0.37	1.80	2.69	1.76	47.3
323152	290	422	385	16	4	3	16.5	0.40	1.68	2.50	1.64	90
323056	305	402	385	16	4	3	29.5	0.37	1.80	2.69	1.76	51.2

Double Row Tapered Roller Bearings

Face-to-face arrangement

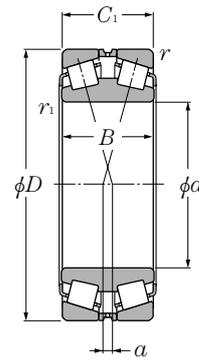

d 280 ~ 500mm

d	Boundary dimensions					dynamic kN	Basic load ratings			Limiting speeds	
	D	B	C ₁	r _{1s min} ¹⁾	r _{s min} ¹⁾		static	dynamic	static	grease	oil
	mm						C _{or}	C _r	C _{or}	min ⁻¹	
								kgf			
280	460	146	146	6	5	1 940	3 650	198 000	375 000	580	770
300	460	118	118	5	4	1 610	3 150	165 000	320 000	570	760
	500	160	160	6	5	2 100	4 050	214 000	415 000	530	710
320	480	121	121	5	4	1 580	3 100	162 000	315 000	530	710
	540	176	176	6	5	2 500	4 900	255 000	500 000	500	660
340	520	133	133	6	5	1 890	3 750	193 000	380 000	500	660
	580	190	190	6	5	3 350	6 500	345 000	660 000	460	620
360	540	134	134	6	5	2 050	4 200	209 000	430 000	460	620
	600	192	192	6	5	3 200	6 500	325 000	660 000	430	580
380	560	135	135	6	5	2 080	4 350	213 000	445 000	440	580
	620	194	194	6	5	3 350	6 700	340 000	685 000	410	540
400	600	148	148	6	5	2 530	5 450	258 000	555 000	410	550
	650	200	200	6	6	3 750	7 850	385 000	800 000	380	510
420	620	150	150	6	5	2 650	5 900	270 000	600 000	390	520
	700	224	224	6	6	4 800	9 700	490 000	990 000	360	480
440	650	157	157	6	6	2 600	5 450	266 000	560 000	370	490
	720	226	226	6	6	5 000	10 300	510 000	1 050 000	340	460
460	680	163	163	6	6	3 050	6 600	310 000	670 000	350	470
	760	240	240	7.5	7.5	4 900	10 300	500 000	1 050 000	320	430
480	700	165	165	6	6	3 050	6 700	310 000	685 000	330	450
	790	248	248	7.5	7.5	5 300	11 100	540 000	1 130 000	310	410
500	720	167	167	6	6	3 050	6 900	315 000	700 000	320	420
	830	264	264	7.5	7.5	6 400	14 000	650 000	1 420 000	290	390

1) Minimum allowable dimension for chamfer dimension r or r₁.

Double Row Tapered Roller Bearings

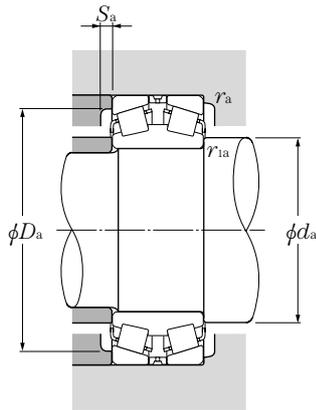

Equivalent radial load dynamic

$$P_r = XF_r + YF_a$$

$\frac{F_a}{F_r} \leq e$		$\frac{F_a}{F_r} > e$	
X	Y	X	Y
1	Y_1	0.67	Y_2

static

$$P_{or} = F_r + Y_0 F_a$$

For values of e , Y_2 and Y_0 see the table below.

Bearing numbers	Abutment and fillet dimensions						Load center mm	Constant e	Axial load factors			Mass kg (approx.)
	d_a max	D_a max	mm		r_{1as} max	r_{as} max			a	Y_1	Y_2	
		min	S_a min									
323156	315	438	400	16	5	4	16	0.40	1.68	2.50	1.64	95.8
323060	330	442	425	16	4	3	31	0.37	1.80	2.69	1.76	70.7
323160	335	478	440	16	5	4	18	0.40	1.68	2.50	1.64	126
323064	350	462	440	16	4	3	34	0.37	1.80	2.69	1.76	76.3
323164	355	518	480	18	5	4	18.5	0.40	1.68	2.50	1.64	164
323068	370	498	480	18	5	4	36	0.37	1.80	2.69	1.76	101
323168	380	558	515	18	5	4	35.5	0.40	1.68	2.50	1.64	207
323072	395	518	495	18	5	4	41	0.37	1.80	2.69	1.76	107
323172	400	578	535	18	5	4	25.5	0.40	1.68	2.50	1.64	218
323076	415	538	515	18	5	4	44.5	0.37	1.80	2.69	1.76	113
323176	420	598	550	20	5	4	29	0.40	1.68	2.50	1.64	229
323080	440	578	550	18	5	4	45	0.37	1.80	2.69	1.76	146
323180	445	622	580	20	5	5	32.5	0.40	1.68	2.50	1.64	259
323084	460	598	570	20	5	4	48.5	0.37	1.80	2.69	1.76	154
323184	465	672	625	25	5	5	60	0.40	1.68	2.50	1.64	346
323088	480	622	600	20	5	5	53.5	0.37	1.80	2.69	1.76	177
323188	485	692	645	25	5	5	44	0.40	1.68	2.50	1.64	361
323092	500	652	620	25	5	5	56.5	0.37	1.80	2.69	1.76	201
323192	525	724	660	25	6	6	34.5	0.40	1.68	2.50	1.64	431
323096	520	672	640	25	5	5	63	0.37	1.80	2.69	1.76	211
323196	547.5	754	688.5	30	6	6	36	0.40	1.68	2.50	1.64	478
3230/500	540	692	655	25	5	5	61.5	0.37	1.80	2.69	1.76	221
5E-3231/500G2	550	794	740	30	6	6	37.5	0.40	1.68	2.50	1.64	570

Four Row Tapered Roller Bearings

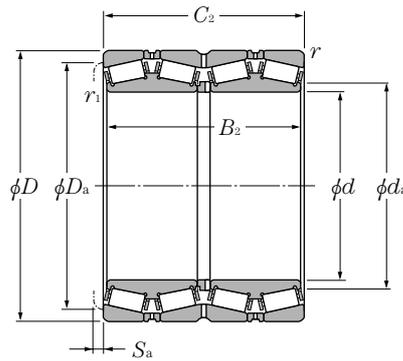

d 120 ~ 187.325mm

d	Boundary dimensions				dynamic		Basic load ratings			
	D	B ₂	C ₂	r _{1s min} ¹⁾	r _{s min} ¹⁾	C _r	static	dynamic	static	
mm										
						kN	kgf			
						C _r	C _{or}	C _r	C _{or}	
120	170	124	124	2.5	2	390	1 020	40 000	104 000	
	210	174	174	2.5	2.5	855	1 710	87 500	174 000	
120.650	174.625	141.288	139.703	0.8	1.5	510	1 220	52 000	124 000	
127	182.562	158.750	158.750	1.5	3.3	660	1 730	67 000	177 000	
130	184	134	134	2.5	2	480	1 190	49 000	122 000	
135	180	160	160	2.5	2	500	1 360	51 000	138 000	
136.525	190.500	161.925	161.925	1.5	3.3	695	1 900	71 000	193 000	
139.700	200.025	157.165	160.340	0.8	3.3	700	1 950	71 500	199 000	
140	198	144	144	2.5	2	575	1 460	58 500	149 000	
146.050	244.475	192.088	187.325	1.5	3.3	955	1 980	97 000	202 000	
150	212	155	155	3	2.5	660	1 700	67 500	173 000	
152.400	222.250	174.625	174.625	1.5	1.5	930	2 350	94 500	239 000	
160	226	165	165	3	2.5	775	2 030	79 000	207 000	
	265	173	173	2.5	2.5	1 100	2 270	112 000	231 000	
165.100	225.425	165.100	168.275	0.8	3.3	745	2 220	76 000	226 000	
170	240	175	175	3	2.5	835	2 200	85 500	224 000	
	280	181	181	2.5	2.5	1 150	2 420	117 000	247 000	
177.800	247.650	192.088	192.088	1.5	3.3	1 000	2 760	102 000	281 000	
	279.400	234.950	234.947	1.5	3.3	1 420	3 400	145 000	345 000	
	304.800	238.227	233.365	3.3	3.3	1 580	3 100	161 000	320 000	
180	254	185	185	3	2.5	910	2 390	93 000	244 000	
	300	280	280	3	3	2 160	4 800	220 000	490 000	
187.325	269.875	211.138	211.138	1.5	3.3	1 240	3 400	127 000	345 000	

1) Minimum allowable dimension for chamfer dimension r or r₁.

● Four Row Tapered Roller Bearings

Bearing numbers	Abutment and fillet dimensions			Mass kg (approx.)
	mm			
	d_a	D_a	S_a	
E-625924	135	155.5	5	8.97
E-CRO-2418	140	190	4.5	22.2
* E-M224749D/M224710/M224710D	129	163	3	11.5
* T-E-48290D/48220/48220D	137	168	4.5	14.3
E-625926	144.5	169	5	11.3
E-CRO-2701	143	165	2	13.5
* T-E-48393D/48320/48320D	144	177	4	14.8
* T-E-48680D/48620/48620D	150	185	3	17.3
E-625928	156	183	5	14
* E-81576D/81962/81963D	163	225	6.5	36.8
E-625930	167.5	195	5.5	16.9
* T-E-M231649D/M231610/M231610D	165	207	4	24.7
E-625932	177.5	208.5	5.5	20.2
E-CRO-3209	184	247	4.5	33.6
* T-E-46791D/46720/46721D	175	209	3	20.7
E-625934	187.5	220	5.5	24.4
E-CRO-3409	192	255	5	44
* E-67791D/67720/67721D	190	229	5	29.4
* E-82681D/82620/82620D	195	251	5	55.3
* E-EE280700D/281200/281201D	198	279	7	69.9
E-625936	200.5	233.5	5.5	28.9
E-CRO-3617	201	274	5	69.4
* E-M238849D/M238810/M238810D	199.9	250	4	41.8

Note: 1. Bearing numbers marked " * " designate inch series bearings.

Four Row Tapered Roller Bearings

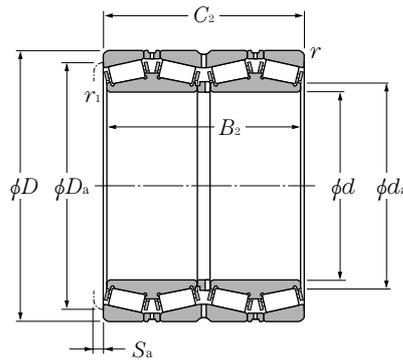

d 190 ~ 260mm

d	Boundary dimensions				dynamic		Basic load ratings		
	D	B ₂	C ₂	r _{1s min} ¹⁾	r _{s min} ¹⁾	kN	static	dynamic	static
	mm							kgf	
						C _r	C _{or}	C _r	C _{or}
190	268	196	196	3	2.5	1 060	2 850	108 000	291 000
	270	190	190	2.5	2.5	1 080	2 940	111 000	300 000
	292.100	225.425	225.425	1.5	3.3	1 570	4 150	160 000	425 000
190.500	266.700	187.325	188.912	1.5	3.3	1 040	2 990	106 000	305 000
200	282	206	206	3	2.5	1 200	3 300	122 000	335 000
	290	160	160	2.5	2.5	925	2 210	94 500	226 000
	310	200	200	3	3	1 360	2 980	138 000	305 000
203.200	317.500	215.900	209.550	3.3	3.3	1 270	2 820	129 000	288 000
215.900	288.925	177.800	177.800	0.8	3.3	1 090	3 100	111 000	315 000
220	310	226	226	4	3	1 380	3 800	141 000	385 000
220.662	314.325	239.712	239.712	1.5	3.3	1 840	4 900	187 000	500 000
228.600	425.450	349.250	361.950	3.5	6.4	3 450	8 250	355 000	845 000
234.950	327.025	196.850	196.850	1.5	3.3	1 370	3 700	140 000	380 000
240	338	248	248	4	3	1 870	4 950	191 000	505 000
241.478	350.838	228.600	228.600	1.5	3.3	1 610	4 000	164 000	410 000
244.475	327.025	193.675	193.675	1.5	3.3	1 430	4 100	146 000	415 000
	381.000	304.800	304.800	3.3	4.8	2 220	5 750	227 000	590 000
250	365	270	270	1.5	3	2 150	6 150	219 000	630 000
	370	220	220	4	4	2 050	5 750	209 000	590 000
254	358.775	269.875	269.875	3.3	3.3	2 390	6 550	244 000	670 000
	368.300	204.622	204.470	1.5	3.3	1 350	3 250	138 000	330 000
	444.500	279.400	279.400	3.3	6.4	2 890	5 900	294 000	600 000
260	368	268	268	5	4	1 990	5 700	203 000	580 000
	400	255	255	4	7.5	2 210	5 300	225 000	540 000

1) Minimum allowable dimension for chamfer dimension r or r₁.

● Four Row Tapered Roller Bearings

Bearing numbers	Abutment and fillet dimensions			Mass kg (approx.)
	mm			
	d_a	D_a	S_a	
E-625938	209	245.5	6	34.7
E-CRO-3812	205	250	6	34.7
* E-M241538D/M241510/M241510D	222	271	5	59.6
* T-E-67885D/67820/67820D	204	246	3	33.6
E-625940	219.5	258	6	40.5
E-CRO-4013	221	271	5	35.1
E-CRO-4014	222	284	6	48.4
* E-EE132082D/132125/132126D	224	294	9.5	62.5
* E-LM742749D/LM742714/LM742714D	227	267	5	34.3
E-625944	242	284.5	6	53.5
* T-E-M244249D/M244210/M244210D	235	293	4	60.2
* E-EE700090D/700167/700168D	263	381	3	232
* T-E-8576D/8520/8520D	250	305	5	53.6
E-625948A	260.5	312	6	70
* E-EE127097D/127137/127137D	262	325	6.5	76.4
* E-LM247748D/LM247710/LM247710DA	257	310	5	46.1
* E-EE126096D/126150/126151D	262	343	6.5	132
E-CRO-5004	275	339	5	82.1
E-CRO-5001	276	344	6	87
* T-E-M249748D/M249710/M249710D	272.5	335	5	85.6
* E-EE171000D/171450/171451D	269	340	6	71.8
* E-EE822101D/822175/822176D	289	406	8	185
E-625952	287	338.5	6	90.3
E-CRO-5215	290	359	8	106

Note: 1. Bearing numbers marked " * " designate inch series bearings.

Four Row Tapered Roller Bearings

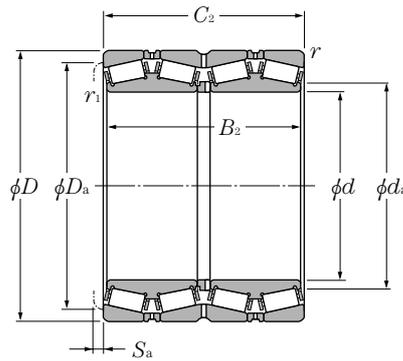

d 260.350 ~ 304.800mm

d	Boundary dimensions				dynamic		Basic load ratings		
	D	B ₂	C ₂	r _{1s min} ¹⁾	r _{s min} ¹⁾	kN	static	dynamic	static
	mm							kgf	
						C _r	C _{or}	C _r	C _{or}
260.350	365.125	228.600	228.600	3.3	6.4	1 750	4 550	178 000	465 000
	400.050	255.588	253.995	1.5	6.4	2 090	4 950	213 000	505 000
	422.275	314.325	317.500	6.4	3.3	2 980	7 100	305 000	725 000
266.700	355.600	230.188	228.600	1.5	3.3	1 840	5 350	188 000	545 000
	393.700	269.878	269.878	3.3	6.4	2 110	6 000	216 000	610 000
269.875	381.000	282.575	282.575	3.3	3.3	2 470	6 850	252 000	700 000
270	410	222	222	4	4	1 910	4 550	195 000	465 000
275	385	200	200	3	3	1 610	4 250	165 000	435 000
276.225	406.400	268.290	260.355	1.5	6.4	2 110	6 000	216 000	610 000
279.400	469.900	346.075	349.250	6.4	3.3	3 500	8 700	355 000	885 000
279.578	380.898	244.475	244.475	1.5	3.3	1 950	6 200	199 000	635 000
280	395	288	288	5	4	2 560	7 100	261 000	725 000
285.750	380.898	244.475	244.475	1.5	3.3	1 950	6 200	199 000	635 000
288.925	406.400	298.450	298.450	3.3	3.3	2 980	8 300	305 000	850 000
292.100	476.250	296.047	292.100	1.5	3.3	3 050	6 800	310 000	695 000
300	424	310	310	5	4	2 570	7 450	262 000	760 000
	460	360	360	4	4	4 050	10 100	415 000	1 030 000
	470	270	270	4	4	3 200	7 250	325 000	740 000
	470	292	292	4	4	3 500	8 300	360 000	845 000
300.038	422.275	311.150	311.150	3.3	3.3	3 350	9 600	340 000	980 000
304.648	438.048	279.400	279.400	3.3	3.3	2 470	6 500	252 000	665 000
	438.048	280.990	279.400	3.3	4.8	2 630	6 900	268 000	700 000
304.800	419.100	269.875	269.875	1.5	6.4	2 390	6 850	244 000	695 000
	444.500	247.650	241.300	8	1.5	1 850	4 600	188 000	470 000

1) Minimum allowable dimension for chamfer dimension r or r_1 .

● Four Row Tapered Roller Bearings

Bearing numbers	Abutment and fillet dimensions			Mass kg (approx.)
	mm			
	d_a	D_a	S_a	
* E-EE134102D/134143/134144D	282	340	6.5	76.5
* E-EE221027D/221575/221576D	292	367	8	117
* E-HM252349D/HM252310/HM252310D	290	392	5.5	180
* T-E-LM451349D/LM451310/LM451310D	281	335	6.5	62
* E-EE275106D/275155/275156D	292	367	5	116
* E-M252349D/M252310/M252310D	290	356	6	97.5
E-CRO-5403	305	382	6	91
E-CRO-5501	300	355	6	62.5
* E-EE275109D/275160/275161D	293.6	366	8	122
* E-EE722111D/722185/722186D	316	432	5	258
* T-E-LM654644D/LM654610/LM654610D	297	356	5	83.2
E-625956	304.5	363.5	7	111
* T-E-LM654648D/LM654610/LM654610D	302	356	5	82.5
* E-M255449D/M255410/M255410DA	310	379	5	125
* E-EE921150D/921875/921876D	321	441	7	208
E-625960	329	389.5	7	138
E-CRO-6015	330	427	10	180
☆ E-CRO-6012	338	438	7	152
☆ E-CRO-6013	336	437	7	164
☆ * T-E-HM256849D/HM256810/HM256810DG2	322	394	6	143
* E-EE329119D/329172/329173D	328	409	8	143
* E-M757448D/M757410/M757410D	328	407	7	140
* E-M257149D/M257110/M257110D	322	392	5	115
* E-EE291202D/291750/291751D	328	416	9.5	127

Note: 1. Bearing numbers marked " * " designate inch series bearings.

2. Bearing numbers marked " ☆ " designate bearing with hollow rollers and pin type cages.

Four Row Tapered Roller Bearings

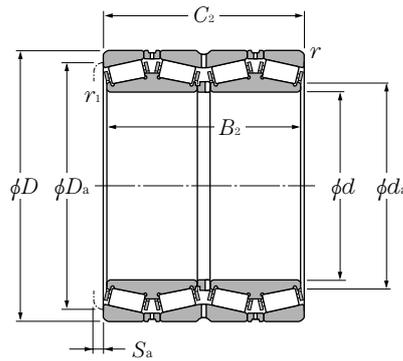

d 304.800 ~ 360mm

d	Boundary dimensions						Basic load ratings		
	D	B ₂	C ₂	r _{1s min} ¹⁾	r _{s min} ¹⁾	dynamic kN	static	dynamic kgf	static
304.800	495.300	342.900	349.250	3.3	6.4	3 650	9 400	370 000	960 000
304.902	412.648	266.700	266.700	3.3	3.3	2 610	7 450	267 000	760 000
305.003	438.048	280.990	279.400	3.3	4.8	2 630	6 900	268 000	700 000
317.500	422.275	269.875	269.875	1.5	3.3	2 260	7 050	231 000	715 000
	447.675	327.025	327.025	3.3	3.3	3 400	9 550	345 000	975 000
320	460	338	338	4	5	2 940	8 650	300 000	880 000
330	470	340	340	2.5	2.5	3 150	10 200	320 000	1 040 000
	510	340	340	6	6	3 900	9 650	395 000	985 000
330.200	482.600	306.388	311.150	1.5	3.3	2 810	7 900	287 000	805 000
333.375	469.900	342.900	342.900	3.3	3.3	4 000	11 000	405 000	1 130 000
340	480	350	350	6	5	3 450	10 400	350 000	1 060 000
341.312	457.098	254.000	254.000	1.5	3.3	2 370	6 900	241 000	705 000
342.900	533.400	307.985	301.625	3.3	3.3	3 150	6 900	320 000	705 000
343.052	457.098	254.000	254.000	1.5	3.3	2 370	6 900	241 000	705 000
346.075	488.950	358.775	358.775	3.3	3.3	4 350	12 800	445 000	1 300 000
347.662	469.900	292.100	292.100	3.3	3.3	3 200	9 100	325 000	925 000
355	490	316	316	1.5	3.3	3 500	10 000	355 000	1 020 000
355.600	444.500	241.300	241.300	1.5	3.3	1 760	6 200	180 000	635 000
	457.200	252.412	252.412	1.5	3.3	2 470	7 850	251 000	800 000
	482.600	265.112	269.875	1.5	3.3	2 790	7 650	285 000	780 000
	488.950	317.500	317.500	1.5	3.3	3 500	10 000	355 000	1 020 000
360	508	370	370	6	5	3 700	11 200	380 000	1 140 000
	600	540	540	5	5	6 700	18 100	685 000	1 840 000

1) Minimum allowable dimension for chamfer dimension r or r₁.

● Four Row Tapered Roller Bearings

Bearing numbers	Abutment and fillet dimensions			Mass kg (approx.)
	mm			
	d_a	D_a	S_a	
* E-EE724121D/724195/724196D	330	450	3	273
* E-M257248D/M257210/M257210D	325	388	5	107
* E-M757449D/M757410/M757410D	328	407	7	139
* E-LM258649D/LM258610/LM258610D	334	398	7	110
* T-E-HM259049D/HM259010/HM259010D	339.6	418	5	161
E-625964	355	420.5	7	183
E-CRO-6604	366	440	5.5	141
E-CRO-6602	366	469	5	221
* E-EE526131D/526190/526191D	351	448	3	197
* E-HM261049D/HM261010/HM261010DA	357	439	5	187
E-625968	373	440	7	200
* E-LM761648D/LM761610/LM761610D	359	432	5	125
* E-EE971355D/972100/972103D	378	502	11	252
* E-LM761649D/LM761610/LM761610D	361	432	5	117
☆ T-E-HM262749D/HM262710/HM262710DG2	371	456	6	227
* E-M262449D/M262410/M262410D	369	443	8	148
E-CRO-7105	378	450	7	170
* E-L163149D/L163110/L163110D	370	422	6.5	89.5
* E-LM263149D/LM263110/LM263110D	372	434	6	106
* E-LM763449D/LM763410/LM763410D	375	453	3	145
* E-M263349D/M263310/M263310D	374	459	5	173
E-625972	394	466.5	7	236
E-CRO-7210	400	550	8	520

Note: 1. Bearing numbers marked " * " designate inch series bearings.

2. Bearing numbers marked " ☆ " designate bearing with hollow rollers and pin type cages.

Four Row Tapered Roller Bearings

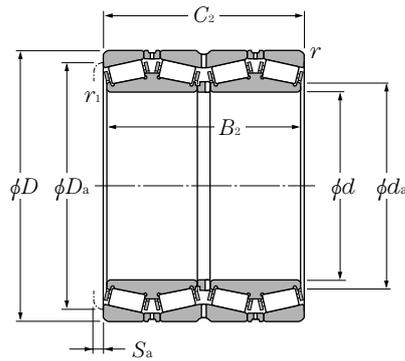

d 368.300 ~ 447.675mm

d	Boundary dimensions				dynamic		Basic load ratings		
	D	B ₂	C ₂	r _{1s min} ¹⁾	r _{s min} ¹⁾	C _r	C _{or} static	C _r dynamic	C _{or} static
mm									
kN									
kgf									
368.300	523.875	382.588	382.588	3.3	6.4	4 450	13 100	455 000	1 330 000
374.650	501.650	250.825	260.350	1.5	3.3	2 360	6 250	241 000	640 000
380	536	390	390	6	5	4 900	14 100	500 000	1 440 000
	560	285	285	5	5	3 250	7 700	330 000	785 000
384.175	546.100	400.050	400.050	3.3	6.4	5 400	16 100	550 000	1 640 000
385.762	514.350	317.500	317.500	3.3	3.3	3 650	11 100	370 000	1 130 000
393.700	546.100	288.925	288.925	1.5	6.4	3 200	10 200	325 000	1 040 000
395	545	268.7	288.7	4	7.5	2 970	8 650	305 000	880 000
	560	380	380	5	5	4 800	14 100	490 000	1 440 000
400	564	412	412	6	5	4 850	14 700	495 000	1 500 000
	546.100	288.925	288.925	1.5	6.4	3 200	10 200	325 000	1 040 000
406.400	590.550	400.050	400.050	3.3	6.4	4 850	13 600	490 000	1 380 000
	609.600	309.562	317.500	3.5	6.4	3 700	9 600	380 000	980 000
	546.100	334.962	334.962	1.5	6.4	4 100	12 700	415 000	1 290 000
409.575	546.100	334.962	334.962	1.5	6.4	4 100	12 700	415 000	1 290 000
415.925	590.550	434.975	434.975	3.3	6.4	6 300	18 900	640 000	1 930 000
420	592	432	432	6	5	5 350	16 300	545 000	1 660 000
	650	460	460	5	5	6 950	18 300	710 000	1 870 000
431.800	571.500	279.400	279.400	1.5	3.3	3 100	9 300	315 000	950 000
	571.500	336.550	336.550	1.5	6.4	3 700	11 800	380 000	1 200 000
432.003	609.524	317.500	317.500	3.5	6.4	4 350	11 500	445 000	1 170 000
440	620	454	454	6	6	6 500	19 900	665 000	2 030 000
	650	355	355	4	7.5	5 350	13 400	545 000	1 370 000
	650	460	460	6	6	6 750	20 700	690 000	2 110 000
447.675	635.000	463.550	463.550	3.3	6.4	7 100	22 100	725 000	2 260 000

1) Minimum allowable dimension for chamfer dimension r or r_1 .

● Four Row Tapered Roller Bearings

Bearing numbers	Abutment and fillet dimensions			Mass kg (approx.)
	mm			
	d_a	D_a	S_a	
☆ * E-HM265049D/HM265010/HM265010DG2	393.7	487	6	280
* E-LM765149D/LM765110/LM765110D	393	472	2	145
E-625976	410	495	8	277
E-CRO-7612	417	525	7	208
☆ * T-E-HM266449D/HM266410/HM266410DG2	411	507	6.5	312
* E-LM665949D/LM665910/LM665910D	409	482	7	240
* E-LM767745D/LM767710/LM767710D	418	510	6.5	219
E-CRO-7901	434	508	3	200
☆ E-CRO-8005	436	515	8	300
E-625980	434	518.5	7	324
* E-LM767749D/LM767710/LM767710D	427	510	6.5	201
* E-EE833161D/833232/833233D	448	549	6.5	395
* E-EE911603D/912400/912401D	441	568	1.5	332
☆ * E-M667947D/M667911/M667911DG2	431	510	5.5	226
☆ * T-E-M268749D/M268710/M268710DG2	444	549	9	421
E-625984	457	545	7	374
E-CRO-8402	455	593	8	600
* J-E-LM869449D/LM869410/LM869410D	453	537	8	198
* E-LM769349D/LM769310/LM769310D	453	534	6.5	232
* E-EE736173D/736238/736239D	464	572	6.5	297
E-625988	479	572.5	8	430
☆ E-CRO-8807	484	607	9	400
E-CRO-8806	483	595	11	600
☆ * E-M270749D/M270710/M270710DAG2	478	591	8	509

Note: 1. Bearing numbers marked " * " designate inch series bearings.

2. Bearing numbers marked " ☆ " designate bearing with hollow rollers and pin type cages.

Four Row Tapered Roller Bearings

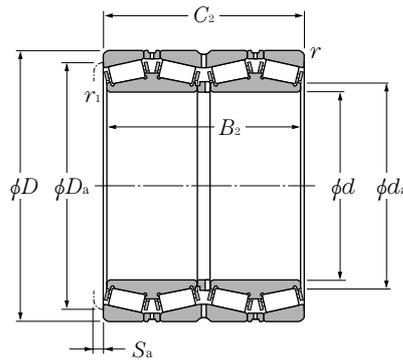

d 457.200 ~ 571.500mm

d	Boundary dimensions				dynamic		Basic load ratings		
	D	B ₂	C ₂	r _{1s min} ¹⁾	r _{s min} ¹⁾	kN	static	dynamic	static
	mm							kgf	
						C _r	C _{or}	C _r	C _{or}
457.200	596.900	276.225	279.400	1.5	3.3	3 350	10 300	360 000	1 060 000
	660.400	323.850	323.847	3.3	6.4	4 150	11 200	425 000	1 140 000
460	650	474	474	6	6	6 500	19 900	665 000	2 030 000
475	660	450	450	3	5	6 300	20 400	645 000	2 080 000
480	678	494	494	6	6	6 250	19 600	640 000	2 000 000
	700	390	390	6	6	4 700	13 400	480 000	1 370 000
482.600	615.950	330.200	330.200	3.3	6.4	4 000	13 400	405 000	1 370 000
488.950	660.400	365.125	361.950	8	6.4	5 350	16 100	550 000	1 640 000
489.026	634.873	320.675	320.675	3.3	3.3	3 650	12 000	370 000	1 220 000
500	670	515	515	1.5	5	6 900	24 600	700 000	2 510 000
	690	480	480	5	5	6 000	19 900	610 000	2 020 000
	705	515	515	6	6	8 450	27 100	860 000	2 760 000
	730	440	440	6	6	7 200	20 600	735 000	2 100 000
501.650	711.200	520.700	520.700	3.3	6.4	8 650	27 300	885 000	2 790 000
514.350	673.100	422.275	422.275	3.3	6.4	5 950	20 500	605 000	2 090 000
519.112	736.600	536.575	536.575	3.3	6.4	9 100	28 700	925 000	2 930 000
520	735	535	535	7	5	9 100	28 700	925 000	2 930 000
536.575	761.873	558.800	558.800	3.3	6.4	10 100	30 500	1 030 000	3 100 000
558.800	736.600	322.265	322.268	3.3	6.4	4 300	13 500	435 000	1 380 000
	736.600	409.575	409.575	3.3	6.4	6 100	20 500	625 000	2 090 000
570	780	515	515	6	6	9 200	31 000	935 000	3 150 000
	810	590	590	6	6	11 000	35 500	1 120 000	3 600 000
571.500	812.800	593.725	593.725	3.3	6.4	11 900	36 500	1 220 000	3 750 000

1) Minimum allowable dimension for chamfer dimension r or r₁.

● Four Row Tapered Roller Bearings

Bearing numbers	Abutment and fillet dimensions			Mass kg (approx.)
	mm			
	d_a	D_a	S_a	
☆ * E-L770849D/L770810/L770810DG2	478	567	5.5	209
* E-EE737179D/737260/737260D	495	616	6.5	379
E-625992A	499	598.5	7	493
E-CRO-9501	506	614	10	465
E-625996	525	623	7	563
E-CRO-9602	517	645	8	436
☆ * E-LM272249D/LM272210/LM272210DG2	504	585	6.5	250
☆ * T-E-EE640193D/640260/640261DG2	519	624	9	364
* E-LM772749D/LM772710/LM772710DA	513	600	6.5	268
E-CRO-10008	520	616	8	598
E-CRO-10005	530	640	7	600
☆ E-6259/500	553	649.5	7.5	632
☆ E-CRO-10003	550	683	11	535
☆ * E-M274149D/M274110/M274110DG2	534	663	9.5	726
* E-LM274449D/LM274410/LM274410D	540	648	8	390
☆ * E-M275349D/M275310/M275310DG2	552	684	9.5	761
☆ E-CRO-10402	558	688	11	750
☆ * E-M276449D/M276410/M276410DG2	564	711	9.5	890
* E-EE843221D/843290/843291D	585	699	8.5	388
☆ * E-LM377449D/LM377410/LM377410DG2	588	696	8	502
☆ E-CRO-11402	609	733	7.5	625
☆ E-CRO-11403	620	760	10	845
☆ * E-M278749D/M278710/M278710DAG2	609	756	11	1 080

Note: 1. Bearing numbers marked " * " designate inch series bearings.

2. Bearing numbers marked " ☆ " designate bearing with hollow rollers and pin type cages.

Four Row Tapered Roller Bearings

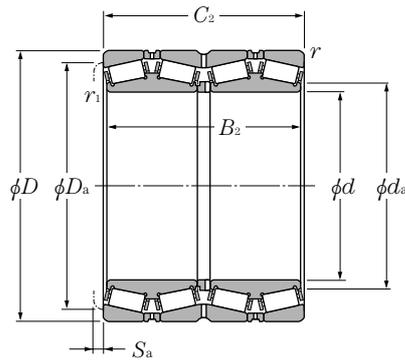

d 584.200 ~ 840mm

d	Boundary dimensions				dynamic		Basic load ratings		
	D	B ₂	C ₂	r _{1s min} ¹⁾	r _{s min} ¹⁾	kN	static	dynamic	static
	mm							kgf	
						C _r	C _{or}	C _r	C _{or}
584.200	762.000	396.875	401.638	3.3	6.4	6 550	22 300	670 000	2 280 000
585.788	771.525	479.425	479.425	3.3	6.4	8 550	29 000	875 000	2 960 000
595.312	844.550	615.950	615.950	3.3	6.4	12 600	40 500	1 290 000	4 100 000
609.600	787.400	361.950	361.950	3.3	6.4	6 450	20 300	655 000	2 070 000
657.225	933.450	676.275	676.275	3.3	6.4	15 300	48 000	1 560 000	4 900 000
660	1 070	642	642	7.5	7.5	15 400	43 500	1 570 000	4 450 000
660.400	812.800	365.125	365.125	3.3	6.4	6 200	23 200	630 000	2 360 000
679.450	901.700	552.450	552.450	3.3	6.4	11 200	38 000	1 140 000	3 900 000
680	870	460	460	3	6	7 500	27 400	765 000	2 790 000
682.625	965.200	701.675	701.675	3.3	6.4	16 100	50 500	1 640 000	5 150 000
685.800	876.300	352.425	355.600	3.3	6.4	6 050	21 800	615 000	2 220 000
710	900	410	410	2.5	5	7 650	26 900	780 000	2 740 000
711.200	914.400	317.500	317.500	3.3	6.4	5 350	17 900	545 000	1 820 000
730	1 070	642	642	7.5	7.5	15 400	46 500	1 570 000	4 750 000
730.250	1 035.050	755.650	755.650	3.3	6.4	18 100	59 500	1 850 000	6 050 000
749.300	990.600	605.000	605.000	3.3	6.4	12 600	45 500	1 290 000	4 650 000
762.000	1 079.500	787.400	787.400	4.8	12.7	19 200	65 000	1 960 000	6 600 000
800	1 120	820	820	7	7.5	21 000	72 500	2 140 000	7 400 000
825.500	1 168.400	844.550	844.550	4.8	12.7	22 300	76 500	2 270 000	7 800 000
840	1 170	840	840	6	6	21 900	76 500	2 230 000	7 800 000

1) Minimum allowable dimension for chamfer dimension r or r₁.

● Four Row Tapered Roller Bearings

Bearing numbers	Abutment and fillet dimensions			Mass kg (approx.)
	mm			
	d_a	D_a	S_a	
☆☆ E-LM778549D/LM778510/LM778510DG2	615	717	7	511
* E-LM278849D/LM278810/LM278810D	615	726	10	750
☆☆ E-M280049D/M280010/M280010DG2	633	786	11	1 160
☆☆ E-EE649241D/649310/649311DG2	636	747	9.5	458
☆☆ E-M281649D/M281610/M281610DG2	699	870	11	1 630
☆ E-CRO-13202	760	991	9	1 950
☆☆ E-L281149D/L281110/L281110DG2	682.8	777	9	448
☆☆ E-LM281849D/LM281810/LM281810DG2	714	852	11	1 040
E-CRO-13602	713	824	8	582
☆☆ E-M282249D/M282210/M282210DG2	723	900	13	1 770
☆☆ E-EE655271D/655345/655346DG2	717	831	8	539
☆ E-CRO-14208	745	850	10	620
☆☆ E-EE755281D/755360/755361DG2	744	873	9.5	527
☆ E-CRO-14601	780	1 020	7	1 900
☆☆ E-M283449D/M283410/M283410DG2	774	966	13	2 210
☆☆ E-LM283649D/LM283610/LM283610DG2	786	936	10.5	1 310
☆☆ E-M284249D/M284210/M284210DG2	810	1 005	13	2 480
☆ E-CRO-16001	858	1 052	10	3 960
☆☆ E-M285848D/M285810/M285810DG2	879	1 085	13	3 010
☆ E-CRO-16803	897	1 099	12	3 970

Note: 1. Bearing numbers marked " * " designate inch series bearings.

2. Bearing numbers marked " ☆ " designate bearing with hollow rollers and pin type cages.

Four Row Tapered Roller Bearings

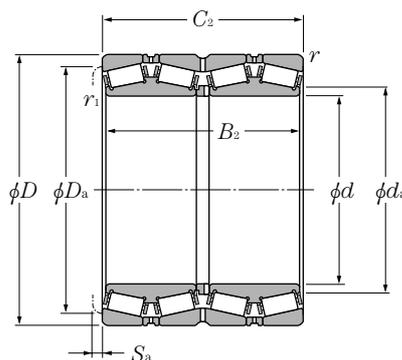

d 863.600 ~ 1 200.150mm

d	Boundary dimensions				dynamic		Basic load ratings		
	D	B ₂	C ₂	r _{1s min} ¹⁾	r _{s min} ¹⁾	kN	static	dynamic	static
	mm							kgf	
						C _r	C _{or}	C _r	C _{or}
863.600	1 130.300	669.925	669.925	4.8	12.7	15 800	59 500	1 610 000	6 050 000
	1 219.200	876.300	889.000	4.8	12.7	24 100	83 000	2 450 000	8 450 000
938.212	1 270.000	825.500	825.500	4.8	12.7	22 500	80 000	2 300 000	8 150 000
950	1 360	880	880	4	7.5	27 000	89 000	2 750 000	9 050 000
1 200.150	1 593.850	990.600	990.600	4.8	12.7	33 500	132 000	3 400 000	13 500 000

چرخ صنعت کشور

1) Minimum allowable dimension for chamfer dimension r or r₁.

● Four Row Tapered Roller Bearings

Bearing numbers	Abutment and fillet dimensions			Mass kg (approx.)
	mm			
	d_a	D_a	S_a	
☆ * E-LM286249D/LM286210/LM286210DG2	906	1 065	11	1 950
☆ * E-EE547341D/547480/547481DG2	918	1 135	6.5	3 640
☆ * E-LM287649D/LM287610/LM287610DG2	990	1 190	10	4 100
☆ E-CRO-19001	1 030	1 278	12	4 100
☆ * E-LM288949D/LM288910/LM288910DG2	1 260	1 500	13	6 130

چرخ صنعت کشور

Note: 1. Bearing numbers marked " * " designate inch series bearings.
2. Bearing numbers marked " ☆ " designate bearing with hollow rollers and pin type cages.

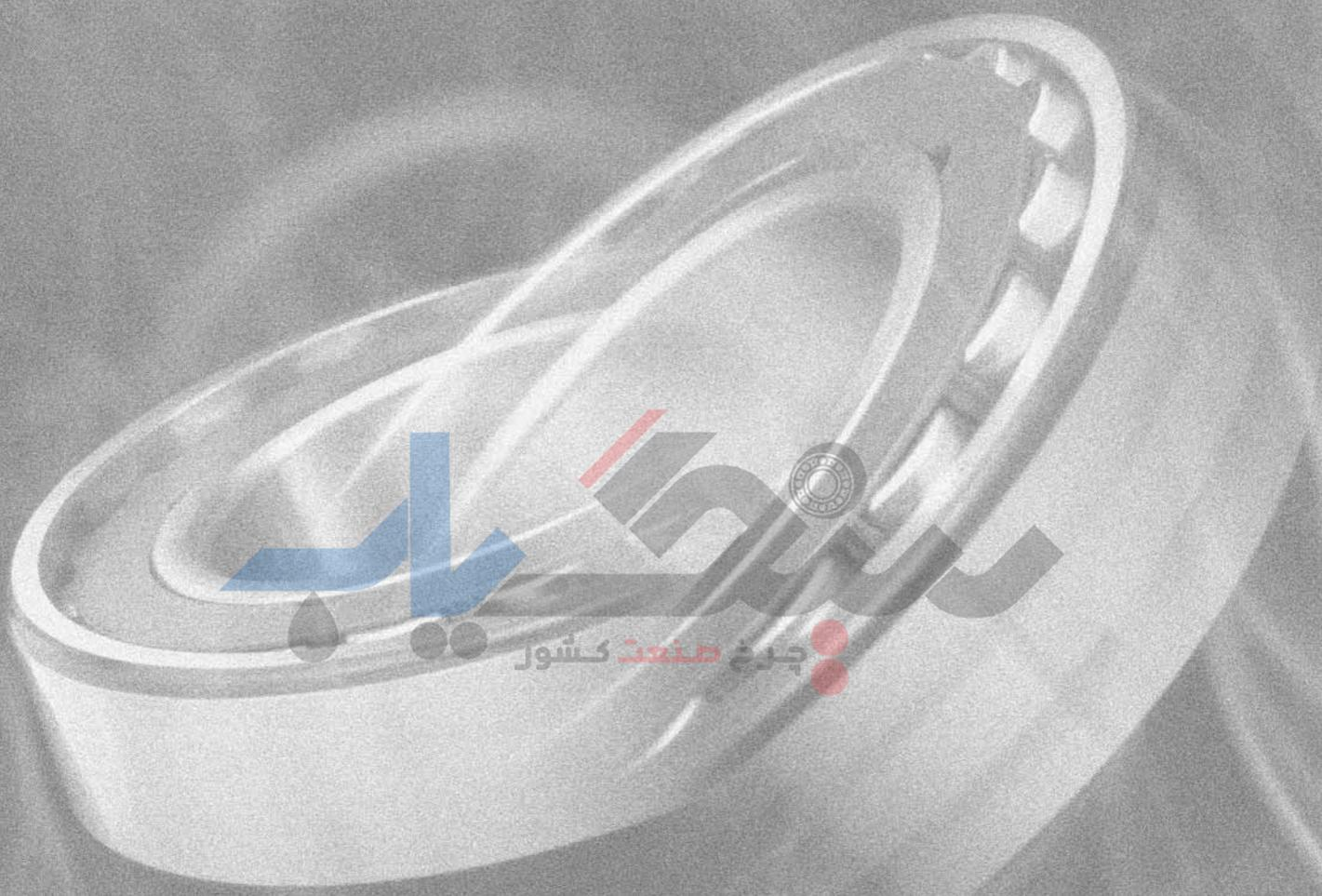

چرخ صنعت کشور



1. Types, construction and characteristics

Spherical roller bearings consist of an outer ring having a continuous spherical raceway within which operates two rows of barrel-shaped rollers which are in turn guided by an inner ring with two raceways separated by a center rib. (Refer to **Diagram 1**) This bearing has self-aligning properties, and therefore is suited for use where misalignment between the inner and outer rings occurs from housing installation error or shaft flexure.

Spherical roller bearings have a large capacity for radial loads, axial loads in either direction, and complex loads. They are also suited for applications where vibration and shock loads are encountered. When operating under axial loads, however, it is desirable to maintain conditions so that $F_a/F_r \leq 2e$ in order to prevent sliding movement along the row of rollers not receiving the axial load. (For the value of e , refer to dimension tables.)

As shown in **Table 1**, in addition to standard type there are various other types of spherical roller bearings. Among these, **Type E** has a particularly high load capacity.

In addition to bearings with cylindrical bore, those with tapered bore are also available. Bearings with tapered bore are specified by attaching the suffix "K" to the end of the bearing's basic number. The standard taper ratio is 1:12 for bearings with a "K" suffix, but for bearings in series 240 and 241 the suffix "K30" indicates the taper ratio for a bearing is 1:30. Most tapered bore bearings incorporate the use of adapters and withdrawal sleeves for shaft mounting.

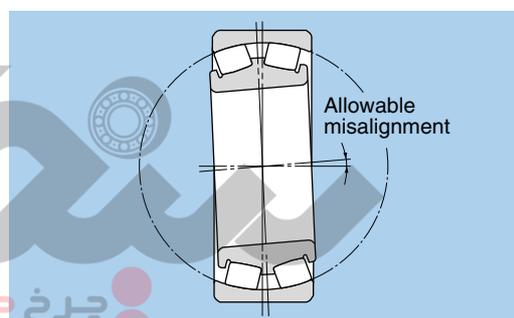

Diagram 1.

Table 1 Types of spherical roller bearings

Type	Standard type (B type)	C type	213 type	E type
Construction				
Bearing series	Does not include C type	Series 222, 223, and 213 with bore dia. of 50 mm or less; series 24024 to 24038.	Series 213 with bore dia. of 55 mm or more	Series 22211 to 22218
Rollers	Asymmetrical	Symmetrical	Asymmetrical	Symmetrical
Roller guide method	Unified inner ring center rib	By guide ring between the 2 rows of rollers	By guide ring between rows of rollers on outer ring raceway	High precision cage (no guide ring, center rib)
cage type	Pressed cage; machined cage	Pressed cage	Machined cage	Molded resin cage

2. Standard cage types

Standard cage types for spherical roller bearings are shown in **Table 2**. In general, pressed cages are standard for small sized bearings, and machined cages are standard for large sized bearings.

E type bearings use as their standard cage type a cage molded from a newly developed glass fiber reinforced **polyamide 46 resin which has excellent heat resistance qualities (allowable operating temperatures up to 150°C)**, strength, as well as unsurpassed oil resistance.

A standard cage may however not be able to be used for high-speed specifications, in high temperature atmospheres, or under excessive vibration/impact conditions. For more information concerning such conditions, please contact NTN Engineering.

Table 2 Standard cage types

Bearing series	Molded resin cage	Pressed cage	Machined cage
239	—	—	23932 ~ 239/1400
230	—	23022B ~ 23048B	23052B ~ 230/1120B
240	—	24024C ~ 24038C	24024B ~ 240/1120B
231	—	23120B ~ 23136B	23138B ~ 231/900B
241	—	—	24122B ~ 241/710B
222	22211E ~ 22218E	22208C ~ 22210C 22211B ~ 22236B	22238B ~ 22264B
232	—	—	23218B ~ 232/750B
213	—	21308C ~ 21310C	21311 ~ 21322
223	—	22308C ~ 22310C 22311B ~ 22328B	22330B ~ 22360B

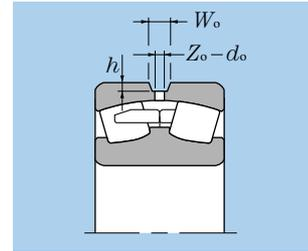

Table 3 Oil inlet and oil groove dimensions

Units mm

Nominal bearing width		Oil groove width W_o	Oil inlet diameter d_o	Oil groove depth h	
over	including			Width series 1, 2, 3	Width series 4
—	30	6	3	1.2	1.0
30	45	7	4	1.5	1.1
45	60	9	5	1.5	1.3
60	80	11	6	2.0	1.5
80	100	14	8	2.5	2.0
100	120	16	10	3.0	2.5
120	160	20	12	3.5	3.0
160	200	27	16	5.0	3.5
200	315	33	20	6.0	5.0
315	—	42	25	7.0	6.5

Table 4 Oil inlet number

Nominal bearing outer diameter mm	Oil inlet number
over up to 320	4
including 320	8
including 1 010	12

If a pin is necessary to prevent outer ring rotation, contact NTN Engineering.

3. Oil inlets and oil groove dimensions

Spherical roller bearings with an outer diameter of 320mm or more are provided with an oil inlet and oil groove on the outer ring for the purpose of supplying lubricant to the bearing's moving parts. When necessary, oil inlets and oil grooves can also be provided on bearings with outer diameters less than 320 mm. In such cases, please add the supplementary suffix code "D1" to the end of the bearing number, and contact NTN Engineering. (Refer to page A-29)

Table 3 lists dimensions for oil inlets and oil grooves. **Table 4** contains information about the number of oil inlets.

4. Allowable misalignment

Spherical roller bearings possess the same self-aligning properties as other self-aligning bearings. The allowable misalignment angle will vary according to dimension series and load conditions, but the following misalignment angles are generally standard:

Normal load (loads equivalent to 0.09 C_r):	0.009rad (0.5°)
Light load:	0.035rad (2°)

5. Adapters and withdrawal sleeves

Adapters are used for installation of bearings with tapered bore on cylindrical shafts. Withdrawal sleeves are also used to install and disassemble bearings with tapered bore onto and off of cylindrical shafts. In disassembling the bearing from the shaft, the nut is pressed down against the edge of the inner ring utilizing the bolt provided on the withdrawal sleeve, and then the sleeve is drawn away from the bearing's inner diameter surface. (Precision of adapter and withdrawal sleeve are stipulated JIS B 1552 and JIS B 1556).

For bearings with a bore diameter of 200 mm or more, high pressure oil (hydraulic) type adapters and withdrawal sleeves have been standardized to make installation and disassembly easier. As shown in **Diagram 2** construction is designed to reduce friction by injecting high pressure oil between the surfaces of the adapter sleeve and bearing inner bore by means of a pressure fitting.

If the oil supply inlet is attached in the nut side of the adapter, the supplementary suffix "HF" should be added to the bearing number; if the oil supply inlet is attached on the opposite side, the suffix "HB" should be added to the bearing number. For adapter sleeves, the supplementary suffix "H" is added to the bearing's number in both cases.

The hydraulic sleeve nut is equipped with holes for bolts used for mounting and dismounting and holes for hydraulic piping. The suffix SP or SPB is added to the bearing number of the nut.

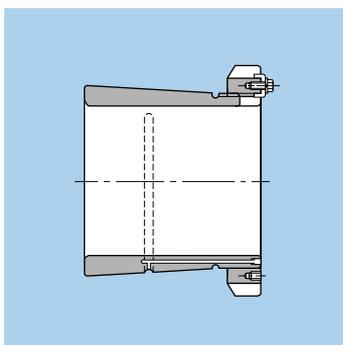

Diagram 2.

6. LH series

In recent years, conditions under which spherical roller bearings are used have become increasingly severe. In particular, longer life is now demanded for use in high temperature environments.

Taking the global environment into account, NTN Engineering has developed a type of steel (STJ2) that offers longer life in a wide range of temperatures, from room temperature all the way up to 250°C. The steel is standardly used in NTN Engineering's **LH series of spherical roller bearings**.

Features are as follows (in comparison with SUJ2):

(1) Longer life in wide range of temperatures.

- 3.5 times longer life at room temperature.
- 30 times longer life at high temperature (250°C).

(2) Resists surface damage.

- 7 times stronger resistance to peeling
- 1.4 times stronger resistance to smearing
- 2.5 times stronger resistance to wear

(3) Dimensions stability at high temperatures.

- Almost no dimensional variation when maintained at 250°C.

(4) Enhanced cracking fatigue strength.

- 2 times longer cracking fatigue life under high temperatures or tight fitting stress.
- 2 times better operating cracking fatigue strength.

(5) Simplified service part stock management.

- Applications ranging from room temperature to 250°C can be handles with a single type of standard bearing.

Items with LH preceding the basic number in the dimensions table are LH series and are gradually being switched.

Bearing numbers without LH can be manufactured according to size. For information, please contact NTN Engineering.

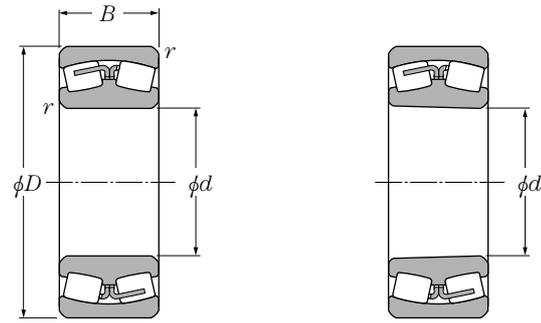

Cylindrical bore

Tapered bore

d 25 ~ 75mm

Boundary dimensions				Basic load ratings				Limiting speeds ¹⁾		Bearing numbers ⁴⁾	
mm				dynamic	static	dynamic	static	min ⁻¹		cylindrical	tapered ²⁾
<i>d</i>	<i>D</i>	<i>B</i>	<i>r</i> _{s min³⁾}	<i>C_r</i>	<i>C_{or}</i>	<i>C_r</i>	<i>C_{or}</i>	grease	oil	bore	bore
25	52	18	1	36.5	36	3 750	3 650	8 500	11 000	22205C	22205CK
30	62	20	1	49	49	5 000	5 000	7 500	9 500	22206C	22206CK
35	72	23	1.1	69.5	71	7 050	7 200	6 500	8 500	22207C	22207CK
40	80	23	1.1	79	88.5	8 050	9 000	6 000	7 600	LH-22208C	LH-22208CK
	90	23	1.5	88	90	8 950	9 150	4 900	6 400	21308C	21308CK
	90	33	1.5	121	128	12 300	13 000	4 500	5 900	22308C	22308CK
45	85	23	1.1	82.5	95	8 400	9 700	5 300	6 800	LH-22209C	LH-22209CK
	100	25	1.5	102	106	10 400	10 800	4 400	5 700	21309C	21309CK
	100	36	1.5	148	167	15 100	17 000	4 100	5 300	22309C	22309CK
50	90	23	1.1	86	102	8 750	10 400	4 900	6 300	LH-22210C	LH-22210CK
	110	27	2	118	127	12 000	12 900	4 000	5 200	21310C	21310CK
	110	40	2	186	212	19 000	21 600	3 700	4 800	22310C	22310CK
55	100	25	1.5	118	144	12 000	14 700	4 400	5 800	LH-22211E	LH-22211EK
	100	25	1.5	93.5	110	9 500	11 200	4 500	5 800	LH-22211B	LH-22211BK
	120	29	2	145	163	14 800	16 600	3 700	4 800	21311	21311K
	120	43	2	204	234	20 800	23 900	3 400	4 400	22311B	22311BK
60	110	28	1.5	150	182	15 300	18 500	4 000	5 300	LH-22212E	LH-22212EK
	110	28	1.5	115	147	11 700	15 000	4 100	5 300	LH-22212B	LH-22212BK
	130	31	2.1	167	191	17 100	19 500	3 400	4 400	21312	21312K
	130	46	2.1	238	273	24 300	27 800	3 100	4 000	22312B	22312BK
65	120	31	1.5	177	217	18 000	22 200	3 800	5 000	LH-22213E	LH-22213EK
	120	31	1.5	143	179	14 600	18 300	3 900	5 000	LH-22213B	LH-22213BK
	140	33	2.1	194	228	19 800	23 200	3 100	4 000	21313	21313K
	140	48	2.1	265	320	27 100	32 500	2 800	3 700	22313B	22313BK
70	125	31	1.5	184	232	18 700	23 600	3 400	4 600	LH-22214E	LH-22214EK
	125	31	1.5	154	201	15 700	20 500	3 500	4 600	LH-22214B	LH-22214BK
	150	35	2.1	220	262	22 400	26 800	2 900	3 800	21314	21314K
	150	51	2.1	325	380	33 000	39 000	2 700	3 500	22314B	22314BK
75	130	31	1.5	190	246	19 400	25 100	3 200	4 200	LH-22215E	LH-22215EK

1) This value was achieved with machined cages and molded resin cages; for pressed cages, 75% of this value is allowable.

2) "K" indicates bearings have tapered bore with a taper ratio of 1:12. 3) Smallest allowable dimension for chamfer dimension *r*.

4) Bearing number with the prefix LH indicates LH series.

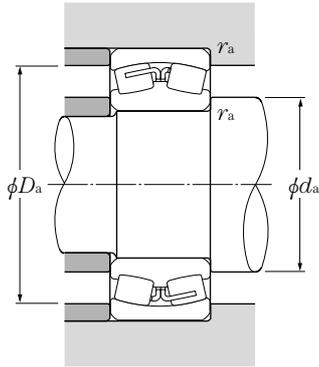

Equivalent radial load
dynamic

$$P_r = XF_r + YF_a$$

$\frac{F_a}{F_r} \leq e$		$\frac{F_a}{F_r} > e$	
X	Y	X	Y
1	Y_1	0.67	Y_2

static

$$P_{or} = F_r + Y_0 F_a$$

For values of e , Y_2 and Y_0 see the table below.

Abutment and fillet dimensions					Constant	Axial load factors			Mass (approx.)	
min	mm		max	max	e	Y_1	Y_2	Y_0	kg	
	d_a	D_a							cylindrical bore	tapered bore
31	—	—	46	1	0.35	1.92	2.86	1.88	0.186	0.182
36	—	—	56	1	0.33	2.07	3.09	2.03	0.287	0.282
42	—	—	65	1	0.32	2.09	3.11	2.04	0.446	0.437
47	—	—	73	1	0.29	2.35	3.50	2.30	0.526	0.515
48.5	—	—	81.5	1.5	0.26	2.55	3.80	2.50	0.705	0.694
48.5	—	—	81.5	1.5	0.38	1.76	2.62	1.72	0.974	0.951
52	—	—	78	1	0.27	2.50	3.72	2.44	0.584	0.572
53.5	—	—	91.5	1.5	0.26	2.60	3.87	2.54	0.927	0.912
53.5	—	—	91.5	1.5	0.36	1.86	2.77	1.82	1.33	1.3
57	—	—	83	1	0.25	2.69	4.01	2.63	0.63	0.616
60	—	—	100	2	0.26	2.64	3.93	2.58	1.21	1.19
60	—	—	100	2	0.37	1.80	2.69	1.76	1.79	1.75
63.5	67	89.5	91.5	1.5	0.24	2.83	4.21	2.76	0.808	0.79
63.5	—	—	91.5	1.5	0.28	2.42	3.61	2.37	0.85	0.832
65	—	—	110	2	0.25	2.69	4.01	2.63	1.71	1.69
65	—	—	110	2	0.40	1.68	2.50	1.64	2.3	2.25
68.5	72	98	101.5	1.5	0.25	2.75	4.09	2.69	1.09	1.07
68.5	—	—	101.5	1.5	0.27	2.49	3.71	2.44	1.15	1.13
72	—	—	118	2	0.25	2.69	4.00	2.63	2.1	2.07
72	—	—	118	2	0.42	1.62	2.42	1.59	2.9	2.83
73.5	78.5	107	111.5	1.5	0.25	2.71	4.04	2.65	1.43	1.4
73.5	—	—	111.5	1.5	0.28	2.42	3.60	2.37	1.5	1.47
77	—	—	128	2	0.25	2.69	4.00	2.63	2.55	2.51
77	—	—	128	2	0.38	1.79	2.67	1.75	3.45	3.37
78.5	83.5	112.5	116.5	1.5	0.24	2.86	4.25	2.79	1.51	1.47
78.5	—	—	116.5	1.5	0.26	2.55	3.80	2.50	1.55	1.52
82	—	—	138	2	0.25	2.69	4.00	2.63	3.18	3.14
82	—	—	138	2	0.37	1.81	2.70	1.77	4.22	4.12
83.5	89	117.5	121.5	1.5	0.22	3.00	4.47	2.94	1.59	1.55

Note: Upon request, bearings with oil inlets and oil grooves on the outer ring can also be manufactured. In such cases, please add the suffix "D1" to the end of the bearing number. (Example: 22214BD1)

Spherical Roller Bearings

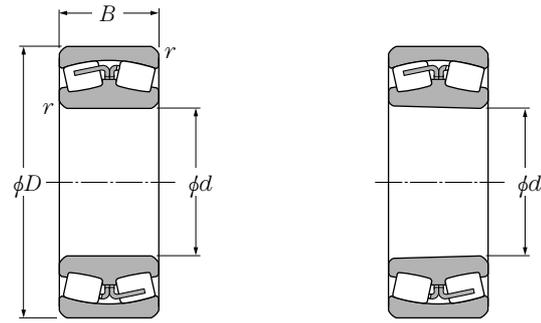

Cylindrical bore

Tapered bore

d 75 ~ 120mm

Boundary dimensions				Basic load ratings				Limiting speeds ¹⁾		Bearing numbers ⁴⁾	
mm				dynamic	static	dynamic	static	min ⁻¹		cylindrical	tapered ²⁾
d	D	B	r _{s min} ³⁾	C _r	C _{or}	C _r	C _{or}	grease	oil	bore	bore
				kN		kgf					
75	130	31	1.5	166	223	16 900	22 800	3 200	4 200	LH-22215B	LH-22215BK
	160	37	2.1	239	287	24 300	29 300	2 700	3 500	21315	21315K
	160	55	2.1	330	410	33 500	42 000	2 500	3 200	22315B	22315BK
80	140	33	2	213	277	21 700	28 200	3 000	4 000	LH-22216E	LH-22216EK
	140	33	2	179	239	18 300	24 400	3 100	4 000	LH-22216B	LH-22216BK
	170	39	2.1	260	315	26 500	32 000	2 500	3 300	21316	21316K
	170	58	2.1	385	470	39 500	48 000	2 300	3 000	22316B	22316BK
85	150	36	2	251	320	25 600	33 000	2 800	3 800	LH-22217E	LH-22217EK
	150	36	2	206	272	21 000	27 800	2 900	3 800	LH-22217B	LH-22217BK
	180	41	3	289	355	29 500	36 000	2 400	3 100	21317	21317K
	180	60	3	415	510	42 500	52 000	2 200	2 900	22317B	22317BK
90	160	40	2	292	385	29 800	39 500	2 600	3 500	LH-22218E	LH-22218EK
	160	40	2	256	345	26 200	35 000	2 700	3 500	LH-22218B	LH-22218BK
	160	52.4	2	315	455	32 500	46 500	2 200	2 800	23218B	23218BK
	190	43	3	320	400	32 500	40 500	2 300	3 000	21318	21318K
	190	64	3	480	590	49 000	60 000	2 100	2 700	22318B	22318BK
95	170	43	2.1	294	390	30 000	39 500	2 500	3 300	22219B	22219BK
	200	45	3	335	420	34 000	43 000	2 100	2 700	21319	21319K
	200	67	3	500	615	51 000	63 000	1 900	2 500	22319B	22319BK
100	165	52	2	310	470	31 500	47 500	2 000	2 600	23120B	23120BK
	180	46	2.1	315	415	32 000	42 500	2 400	3 200	22220B	22220BK
	180	60.3	2.1	405	580	41 500	59 000	1 900	2 500	23220B	23220BK
	215	47	3	370	465	37 500	47 500	2 000	2 600	21320	21320K
	215	73	3	605	755	61 500	77 000	1 800	2 400	22320B	22320BK
110	170	45	2	282	455	28 800	46 500	2 200	2 800	23022B	23022BK
	180	56	2	370	580	37 500	59 500	1 800	2 400	23122B	23122BK
	180	69	2	450	755	46 000	77 000	1 800	2 400	24122B	24122BK30
	200	53	2.1	410	570	42 000	58 000	2 200	2 800	22222B	22222BK
	200	69.8	2.1	515	760	52 500	77 500	1 700	2 200	23222B	23222BK
	240	50	3	495	615	50 500	62 500	1 800	2 300	21322	21322K
	240	80	3	745	930	76 000	95 000	1 700	2 200	22322B	22322BK
120	180	46	2	296	495	30 000	50 500	2 000	2 600	23024B	23024BK

1) This value was achieved with machined cages and molded resin cages; for pressed cages, 75% of this value is allowable.

2) Bearings appended with "K" have a tapered bore ratio of 1:12. 3) Smallest allowable dimension for chamfer dimension r.

4) Bearing number with the prefix LH indicates LH series.

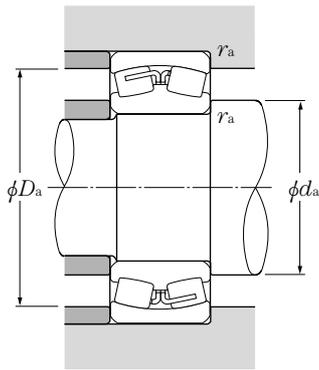

Equivalent radial load
dynamic

$$P_r = XF_r + YF_a$$

$\frac{F_a}{F_r} \leq e$		$\frac{F_a}{F_r} > e$	
X	Y	X	Y
1	Y_1	0.67	Y_2

static

$$P_{or} = F_r + Y_0 F_a$$

For values of e , Y_2 and Y_0 see the table below.

Abutment and fillet dimensions					Constant	Axial load factors			Mass (approx.)	
d_a		mm		r_{as}	e	Y_1	Y_2	Y_0	kg	
min	max	min	max						cylindrical bore	tapered bore
83.5	—	—	121.5	1.5	0.24	2.81	4.19	2.75	1.65	1.61
87	—	—	148	2	0.24	2.84	4.23	2.78	3.81	3.76
87	—	—	148	2	0.37	1.80	2.69	1.76	5.25	5.13
90	94.5	125.5	130	2	0.22	3.01	4.48	2.94	1.99	1.94
90	—	—	130	2	0.26	2.64	3.93	2.58	2.15	2.11
92	—	—	158	2	0.23	2.95	4.39	2.88	4.53	4.47
92	—	—	158	2	0.37	1.80	2.69	1.76	6.05	5.91
95	100.5	135	140	2	0.23	2.96	4.41	2.90	2.49	2.43
95	—	—	140	2	0.26	2.60	3.88	2.55	2.66	2.61
99	—	—	166	2.5	0.25	2.69	4.00	2.63	5.35	5.28
99	—	—	166	2.5	0.37	1.82	2.71	1.78	7.1	6.94
100	107.5	144	150	2	0.24	2.86	4.25	2.79	3.24	3.16
100	—	—	150	2	0.26	2.55	3.80	2.49	3.5	3.42
100	—	—	150	2	0.33	2.04	3.03	1.99	4.45	4.32
104	—	—	176	2.5	0.24	2.83	4.22	2.77	6.3	6.21
104	—	—	176	2.5	0.37	1.80	2.69	1.76	8.35	8.16
107	—	—	158	2	0.26	2.63	3.92	2.57	4.1	4.01
109	—	—	186	2.5	0.23	3.00	4.46	2.93	7.1	7
109	—	—	186	2.5	0.37	1.80	2.69	1.76	9.76	9.54
110	—	—	155	2	0.32	2.12	3.15	2.07	4.3	4.16
112	—	—	168	2	0.26	2.55	3.80	2.49	4.95	4.84
112	—	—	168	2	0.34	1.98	2.94	1.93	6.47	6.28
114	—	—	201	2.5	0.22	3.01	4.48	2.94	8.89	8.78
114	—	—	201	2.5	0.37	1.80	2.69	1.76	12.4	12.1
120	—	—	160	2	0.26	2.59	3.85	2.53	3.71	3.58
120	—	—	170	2	0.31	2.17	3.24	2.13	5.4	5.22
120	—	—	170	2	0.38	1.76	2.63	1.73	7.07	6.96
122	—	—	188	2	0.27	2.51	3.74	2.46	7.2	7.04
122	—	—	188	2	0.35	1.91	2.84	1.86	9.71	9.43
124	—	—	226	2.5	0.21	3.20	4.77	3.13	11.2	11.1
124	—	—	226	2.5	0.36	1.87	2.79	1.83	17.1	16.7
130	—	—	170	2	0.25	2.69	4.01	2.63	4.05	3.9

Note: Upon request, bearings with oil inlets and oil grooves on the outer ring can also be manufactured. In such cases, please add the suffix "D1" to the end of the bearing number. (Example: 23024BD1)

Spherical Roller Bearings

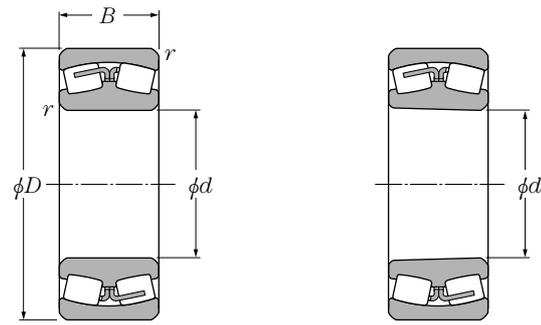

Cylindrical bore

Tapered bore

d 120 ~ 160mm

d	Boundary dimensions			dynamic kN	Basic load ratings		Limiting speeds ¹⁾		Bearing numbers ⁴⁾		
	D	B	r _{s min} ³⁾		static kN	dynamic kgf	grease	oil	cylindrical bore	tapered ²⁾ bore	
120	180	60	2	390	670	39 500	68 500	1 800	2 300	24024B	24024BK30
	180	60	2	395	695	40 000	71 000	1 800	2 300	24024C	24024CK30
	200	62	2	455	705	46 500	71 500	1 600	2 100	23124B	23124BK
	200	80	2	575	945	58 500	96 500	1 600	2 100	24124B	24124BK30
	215	58	2.1	485	700	49 500	71 500	2 000	2 600	22224B	22224BK
	215	76	2.1	585	880	59 500	89 500	1 500	2 000	23224B	23224BK
	260	86	3	880	1 120	89 500	114 000	1 500	2 000	22324B	22324BK
130	200	52	2	375	620	38 500	63 500	1 800	2 300	23026B	23026BK
	200	69	2	505	895	51 500	91 000	1 600	2 100	24026B	24026BK30
	200	69	2	490	860	50 000	87 500	1 600	2 100	24026C	24026CK30
	210	64	2	495	795	50 500	81 000	1 500	2 000	23126B	23126BK
	210	80	2	585	995	60 000	102 000	1 500	2 000	24126B	24126BK30
	230	64	3	570	790	58 000	80 500	1 800	2 400	22226B	22226BK
	230	80	3	685	1 060	70 000	108 000	1 500	1 900	23226B	23226BK
	280	93	4	1 000	1 290	102 000	131 000	1 400	1 800	22326B	22326BK
140	210	53	2	405	690	41 000	70 500	1 700	2 200	23028B	23028BK
	210	69	2	510	945	52 000	96 500	1 500	1 900	24028B	24028BK30
	210	69	2	520	940	53 000	95 500	1 500	1 900	24028C	24028CK30
	225	68	2.1	540	895	55 000	91 000	1 400	1 800	23128B	23128BK
	225	85	2.1	670	1 150	68 500	117 000	1 400	1 800	24128B	24128BK30
	250	68	3	685	975	70 000	99 500	1 700	2 200	22228B	22228BK
	250	88	3	805	1 270	82 000	129 000	1 300	1 700	23228B	23228BK
	300	102	4	1 130	1 460	115 000	149 000	1 300	1 700	22328B	22328BK
150	225	56	2.1	445	775	45 500	79 000	1 500	2 000	23030B	23030BK
	225	75	2.1	585	1 060	59 500	108 000	1 400	1 800	24030B	24030BK30
	225	75	2.1	600	1 090	61 000	111 000	1 400	1 800	24030C	24030CK30
	250	80	2.1	730	1 190	74 500	121 000	1 300	1 700	23130B	23130BK
	250	100	2.1	885	1 520	90 500	155 000	1 300	1 700	24130B	24130BK30
	270	73	3	775	1 160	79 000	119 000	1 600	2 000	22230B	22230BK
	270	96	3	935	1 460	95 000	149 000	1 200	1 600	23230B	23230BK
	320	108	4	1 270	1 750	130 000	179 000	1 200	1 600	22330B	22330BK
160	220	45	2	320	610	33 000	62 500	1 500	2 000	23932	23932K
	240	60	2.1	505	885	51 500	90 000	1 500	1 900	23032B	23032BK
	240	80	2.1	650	1 200	66 500	122 000	1 300	1 700	24032B	24032BK30
	240	80	2.1	665	1 250	67 500	127 000	1 300	1 700	24032C	24032CK30

1) This value was achieved with machined cages and molded resin cages; for pressed cages, 75% of this value is allowable.

2) Bearings appended with "K" have a tapered bore ratio of 1:12. 3) Smallest allowable dimension for chamfer dimension r.

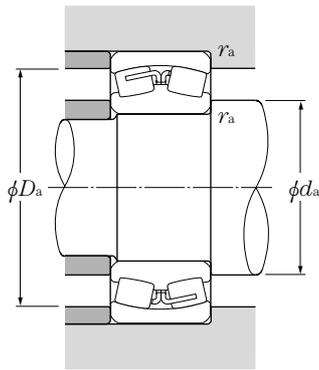

Equivalent radial load
dynamic

$$P_r = XF_r + YF_a$$

$\frac{F_a}{F_r} \leq e$		$\frac{F_a}{F_r} > e$	
X	Y	X	Y
1	Y_1	0.67	Y_2

static

$$P_{or} = F_r + Y_0 F_a$$

For values of e , Y_2 and Y_0 see the table below.

Abutment and fillet dimensions			Constant	Axial load factors			Mass (approx.)	
d_a	D_a	r_{as}	e	Y_1	Y_2	Y_0	cylindrical bore	tapered bore
min	max	max					kg	
130	170	2	0.33	2.06	3.07	2.02	5.48	5.39
130	170	2	0.32	2.12	3.15	2.07	5.48	4.91
130	190	2	0.31	2.17	3.24	2.13	7.7	7.46
130	190	2	0.40	1.68	2.50	1.64	10.3	10.1
132	203	2	0.27	2.47	3.68	2.42	9.1	8.89
132	203	2	0.36	1.89	2.82	1.85	12.1	11.7
134	246	2.5	0.37	1.80	2.69	1.76	21.5	21
<hr/>								
140	190	2	0.26	2.63	3.92	2.57	5.9	5.69
140	190	2	0.34	1.98	2.95	1.94	8.08	7.95
140	190	2	0.32	2.12	3.15	2.07	7.91	7.78
140	200	2	0.30	2.23	3.32	2.18	8.47	8.2
140	200	2	0.38	1.78	2.65	1.74	11	10.8
144	216	2.5	0.28	2.39	3.56	2.33	11.2	10.9
144	216	2.5	0.35	1.92	2.86	1.88	14.3	13.9
148	262	3	0.37	1.81	2.69	1.77	26.8	26.2
<hr/>								
150	200	2	0.25	2.73	4.06	2.67	6.35	6.12
150	200	2	0.32	2.09	3.12	2.05	8.57	8.43
150	200	2	0.30	2.23	3.32	2.18	8.48	7.66
152	213	2	0.30	2.25	3.35	2.20	10.2	9.86
152	213	2	0.38	1.80	2.68	1.76	13.3	13.1
154	236	2.5	0.28	2.39	3.55	2.33	14	13.7
154	236	2.5	0.36	1.90	2.83	1.86	18.8	18.2
158	282	3	0.37	1.80	2.69	1.76	33.8	33
<hr/>								
162	213	2	0.24	2.76	4.11	2.70	7.73	7.45
162	213	2	0.33	2.06	3.07	2.02	10.7	10.5
162	213	2	0.30	2.25	3.34	2.20	10.5	10.3
162	238	2	0.32	2.11	3.15	2.06	15.6	15.1
162	238	2	0.40	1.69	2.51	1.65	20.2	20
164	256	2.5	0.27	2.46	3.66	2.4	18.1	17.7
164	256	2.5	0.36	1.88	2.79	1.83	24.1	23.4
168	302	3	0.35	1.92	2.86	1.88	42.7	41.8
<hr/>								
170	210	2	0.18	3.69	5.49	3.61	5.5	5.33
172	228	2	0.25	2.74	4.09	2.68	9.42	9.09
172	228	2	0.32	2.10	3.13	2.06	13	12.8
172	228	2	0.31	2.18	3.24	2.13	12	11.8

Note: An oil groove is provided for outer rings of bearings with an outer diameter (D dimension) of 320 mm or more. See page B-212 on dimensions. We can make bearings with oil hole or oil groove in the outer ring, per your request, for an outer diameter of 320mm or less. Such bearings are indicated by attaching "D1" to the end of the bearing number. (ex. 23032BD1)

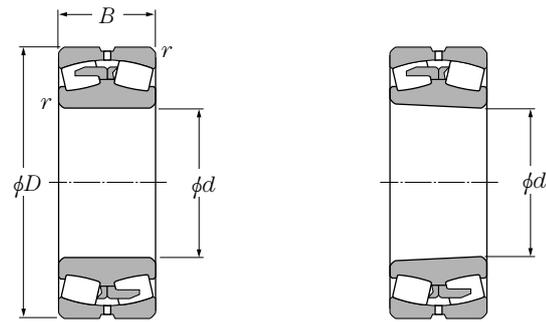

Cylindrical bore

Tapered bore

d 160 ~ 200mm

Boundary dimensions	mm			Basic load ratings				Limiting speeds ¹⁾		Bearing numbers ⁴⁾	
	d	D	B	r _{s min} ³⁾	dynamic kN	static kN	dynamic kgf	static kgf	grease min ⁻¹	oil min ⁻¹	cylindrical bore
160	270	86	2.1	840	1 370	85 500	140 000	1 200	1 600	23132B	23132BK
	270	109	2.1	1 040	1 780	106 000	181 000	1 200	1 600	24132B	24132BK30
	290	80	3	870	1 290	88 500	132 000	1 500	1 900	22232B	22232BK
	290	104	3	1 050	1 660	107 000	170 000	1 200	1 500	23232B	23232BK
	340	114	4	1 410	1 990	144 000	203 000	1 200	1 500	22332B	22332BK
170	230	45	2	330	650	34 000	66 000	1 500	1 900	23934	23934K
	260	67	2.1	630	1 080	64 000	110 000	1 400	1 800	23034B	23034BK
	260	90	2.1	800	1 470	81 500	150 000	1 200	1 600	24034B	24034BK30
	260	90	2.1	815	1 500	83 000	153 000	1 200	1 600	24034C	24034CK30
	280	88	2.1	885	1 490	90 500	152 000	1 200	1 500	23134B	23134BK
	280	109	2.1	1 080	1 880	110 000	191 000	1 200	1 500	24134B	24134BK30
	310	86	4	1 000	1 520	102 000	155 000	1 400	1 800	22234B	22234BK
	310	110	4	1 180	1 960	120 000	200 000	1 100	1 400	23234B	23234BK
360	120	4	1 540	2 180	157 000	223 000	1 100	1 400	22334B	22334BK	
180	250	52	2	440	835	45 000	85 000	1 400	1 800	23936	23936K
	280	74	2.1	740	1 290	75 500	132 000	1 300	1 700	23036B	23036BK
	280	100	2.1	965	1 770	98 500	181 000	1 200	1 500	24036B	24036BK30
	280	100	2.1	965	1 770	98 500	181 000	1 200	1 500	24036C	24036CK30
	300	96	3	1 030	1 730	105 000	176 000	1 100	1 400	23136B	23136BK
	300	118	3	1 250	2 210	127 000	225 000	1 100	1 400	24136B	24136BK30
	320	86	4	1 040	1 610	106 000	164 000	1 300	1 700	22236B	22236BK
	320	112	4	1 230	2 000	125 000	204 000	1 000	1 300	23236B	23236BK
380	126	4	1 740	2 560	177 000	261 000	1 000	1 300	22336B	22336BK	
190	260	52	2	460	890	47 000	91 000	1 300	1 700	23938	23938K
	290	75	2.1	755	1 350	77 000	138 000	1 200	1 600	23038B	23038BK
	290	100	2.1	995	1 850	102 000	188 000	1 100	1 400	24038B	24038BK30
	290	100	2.1	970	1 820	98 500	186 000	1 100	1 400	24038C	24038CK30
	320	104	3	1 190	2 020	122 000	206 000	1 000	1 300	23138B	23138BK
	320	128	3	1 420	2 480	144 000	253 000	1 000	1 300	24138B	24138BK30
	340	92	4	1 160	1 810	118 000	185 000	1 200	1 600	22238B	22238BK
	340	120	4	1 400	2 330	143 000	237 000	920	1 200	23238B	23238BK
400	132	5	1 870	2 790	191 000	284 000	920	1 200	22338B	22338BK	
200	280	60	2.1	545	1 100	56 000	112 000	1 200	1 600	23940	23940K
	310	82	2.1	915	1 620	93 000	165 000	1 200	1 500	23040B	23040BK
	310	109	2.1	1 160	2 140	118 000	219 000	1 000	1 300	24040B	24040BK30

1) This value was achieved with machined cages and molded resin cages; for pressed cages, 75% of this value is allowable.

2) Bearings appended with "K" have a tapered bore ratio of 1:12. 3) Smallest allowable dimension for chamfer dimension r.

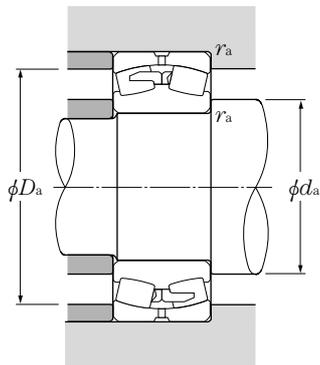

Equivalent radial load

$P_r = XF_r + YF_a$

$\frac{F_a}{F_r} \leq e$		$\frac{F_a}{F_r} > e$	
X	Y	X	Y
1	Y_1	0.67	Y_2

static

$P_{or} = F_r + Y_0 F_a$

For values of e , Y_2 and Y see the table below.

Abutment and fillet dimensions			Constant e	Axial load factors			Mass (approx.)	
d_a min	D_a max	r_{as} max		Y_1	Y_2	Y_0	cylindrical bore kg	tapered bore kg
172	258	2	0.32	2.11	3.15	2.07	19.8	19.2
172	258	2	0.40	1.67	2.48	1.63	26	25.6
174	276	2.5	0.28	2.42	3.60	2.37	22.7	22.2
174	276	2.5	0.36	1.86	2.77	1.82	30	29.1
178	322	3	0.35	1.94	2.89	1.90	50.8	49.7
180	220	2	0.17	3.91	5.83	3.83	5.8	5.62
182	248	2	0.25	2.66	3.96	2.60	12.7	12.3
182	248	2	0.34	1.98	2.95	1.94	17.7	17.4
182	248	2	0.31	2.16	3.22	2.12	17.4	17.1
182	268	2	0.31	2.15	3.21	2.11	21.5	20.8
182	268	2	0.39	1.74	2.59	1.70	27.2	26.8
188	292	3	0.28	2.39	3.56	2.34	28	27.3
188	292	3	0.36	1.87	2.79	1.83	36.8	35.7
188	342	3	0.34	1.96	2.91	1.91	59.8	58.5
190	240	2	0.19	3.52	5.25	3.45	8.21	7.95
192	268	2	0.26	2.59	3.85	2.53	16.7	16.1
192	268	2	0.35	1.91	2.85	1.87	23.3	22.9
192	268	2	0.33	2.04	3.04	2.00	23	22.6
194	286	2.5	0.32	2.11	3.15	2.07	25.1	24.2
194	286	2.5	0.39	1.72	2.56	1.68	34.3	33.8
198	302	3	0.27	2.49	3.70	2.43	29.3	28.6
198	302	3	0.35	1.91	2.84	1.86	39	37.8
198	362	3	0.34	1.97	2.93	1.92	70	68.5
200	250	2	0.18	3.81	5.67	3.73	8.6	8.34
202	278	2	0.26	2.65	3.94	2.59	17.7	17.1
202	278	2	0.33	2.03	3.02	1.98	24.3	23.9
202	278	2	0.31	2.16	3.22	2.12	23	22.6
204	306	2.5	0.33	2.07	3.09	2.03	35.3	34.2
204	306	2.5	0.40	1.69	2.51	1.65	42.8	42.2
208	322	3	0.27	2.47	3.68	2.42	36.6	35.8
208	322	3	0.36	1.89	2.82	1.85	47.6	46.2
212	378	4	0.34	1.97	2.94	1.93	81	79.3
212	268	2	0.17	3.91	5.82	3.82	12.1	11.7
212	298	2	0.26	2.59	3.85	2.53	22.7	21.9
212	298	2	0.35	1.94	2.89	1.90	31	30.5

Note: An oil groove is provided for outer rings of bearings with an outer diameter (D dimension) of 320 mm or more. See page B-220 on dimensions. We can make bearings with oil hole or oil groove in the outer ring, per your request, for an outer diameter of 320mm or less. Such bearings are indicated by attaching "D1" to the end of the bearing number. (ex. 23032BD1)

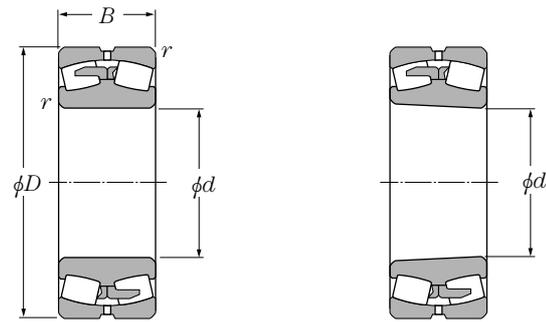

Cylindrical bore

Tapered bore

d 200 ~ 280mm

d	Boundary dimensions			dynamic Cr	Basic load ratings		dynamic Cr	static Cor	Limiting speeds		Bearing numbers ³⁾	
	mm	mm	r _{s min} ²⁾		kN	kgf			grease	oil	min ⁻¹	min ⁻¹
200	340	112	3	1 350	2 270	137 000	231 000	920	1 200	23140B	23140BK	
	340	140	3	1 630	2 900	166 000	295 000	920	1 200	24140B	24140BK30	
	360	98	4	1 310	2 010	134 000	205 000	1 100	1 500	22240B	22240BK	
	360	128	4	1 610	2 640	165 000	269 000	920	1 200	23240B	23240BK	
	420	138	5	2 040	3 050	208 000	310 000	850	1 100	22340B	22340BK	
220	300	60	2.1	565	1 170	57 500	119 000	1 100	1 400	23944	23944K	
	340	90	3	1 060	1 920	108 000	195 000	1 000	1 300	23044B	23044BK	
	340	118	3	1 350	2 570	138 000	262 000	920	1 200	24044B	24044BK30	
	370	120	4	1 540	2 670	157 000	272 000	850	1 100	23144B	23144BK	
	370	150	4	1 880	3 400	192 000	345 000	850	1 100	24144B	24144BK30	
	400	108	4	1 580	2 460	161 000	251 000	1 000	1 300	22244B	22244BK	
	400	144	4	2 010	3 350	205 000	340 000	770	1 000	23244B	23244BK	
460	145	5	2 350	3 500	240 000	360 000	770	1 000	22344B	22344BK		
240	320	60	2.1	565	1 190	58 000	121 000	1 000	1 300	23948	23948K	
	360	92	3	1 130	2 140	116 000	219 000	920	1 200	23048B	23048BK	
	360	118	3	1 410	2 770	144 000	282 000	850	1 100	24048B	24048BK30	
	400	128	4	1 730	3 050	177 000	310 000	770	1 000	23148B	23148BK	
	400	160	4	2 110	3 800	215 000	390 000	770	1 000	24148B	24148BK30	
	440	120	4	1 940	3 100	198 000	315 000	920	1 200	22248B	22248BK	
	440	160	4	2 430	4 100	247 000	420 000	720	940	23248B	23248BK	
500	155	5	2 720	4 100	278 000	420 000	720	930	22348B	22348BK		
260	360	75	2.1	760	1 580	77 500	161 000	920	1 200	23952	23952K	
	400	104	4	1 420	2 620	144 000	267 000	850	1 100	23052B	23052BK	
	400	140	4	1 830	3 550	186 000	365 000	750	980	24052B	24052BK30	
	440	144	4	2 140	3 850	219 000	395 000	710	920	23152B	23152BK	
	440	180	4	2 510	4 600	256 000	470 000	710	920	24152B	24152BK30	
	480	130	5	2 230	3 600	228 000	365 000	850	1 100	22252B	22252BK	
	480	174	5	2 760	4 700	281 000	480 000	660	860	23252B	23252BK	
540	165	6	3 100	4 750	320 000	485 000	650	850	22352B	22352BK		
280	380	75	2.1	830	1 750	84 500	179 000	850	1 100	23956	23956K	
	420	106	4	1 510	2 920	154 000	297 000	770	1 000	23056B	23056BK	
	420	140	4	1 950	3 950	199 000	405 000	690	900	24056B	24056BK30	
	460	146	5	2 300	4 250	234 000	435 000	650	850	23156B	23156BK	
	460	180	5	2 730	5 200	278 000	530 000	650	850	24156B	24156BK30	
500	130	5	2 310	3 800	236 000	390 000	770	1 000	22256B	22256BK		

1) Bearings appended with "K" have a tapered bore ratio of 1:12; bearings appended with "K30" have a tapered bore ratio of 1:30.

2) Smallest allowable dimension for chamfer dimension r.

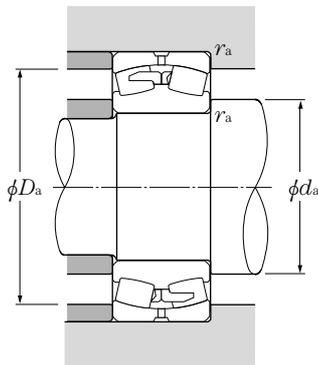

Equivalent radial load
dynamic

$$P_r = XF_r + YF_a$$

$\frac{F_a}{F_r} \leq e$		$\frac{F_a}{F_r} > e$	
X	Y	X	Y
1	Y ₁	0.67	Y ₂

static

$$P_{or} = F_r + Y_0 F_a$$

For values of e , Y_2 and Y_0 see the table below.

Abutment and fillet dimensions			Constant	Axial load factors			Mass (approx.)	
d_a	D_a	r_{as}	e	Y_1	Y_2	Y_0	cylindrical bore	tapered bore
min	max	max					kg	
214	326	2.5	0.33	2.05	3.05	2.00	43.3	42
214	326	2.5	0.41	1.64	2.44	1.60	53.4	52.6
218	342	3	0.28	2.45	3.64	2.39	44	43
218	342	3	0.36	1.88	2.79	1.83	57.2	55.5
222	398	4	0.34	1.98	2.95	1.94	93.2	91.2
<hr/>								
232	288	2	0.19	3.62	5.39	3.54	13.1	12.7
234	326	2.5	0.26	2.59	3.85	2.53	29.9	28.8
234	326	2.5	0.34	1.97	2.94	1.93	40.2	39.6
238	352	3	0.33	2.07	3.09	2.03	53.3	51.6
238	352	3	0.41	1.66	2.47	1.62	67	66
238	382	3	0.27	2.46	3.66	2.40	60.4	59.1
238	382	3	0.36	1.85	2.76	1.81	80	77.6
242	438	4	0.33	2.06	3.07	2.02	117	115
<hr/>								
252	308	2	0.16	4.13	6.15	4.04	14	13.6
254	346	2.5	0.25	2.69	4.01	2.63	33.4	32.2
254	346	2.5	0.32	2.09	3.12	2.05	43	42.3
258	382	3	0.32	2.11	3.15	2.07	65.8	63.8
258	382	3	0.40	1.69	2.51	1.65	82.2	80.9
258	422	3	0.28	2.43	3.62	2.38	81.7	80
258	422	3	0.37	1.83	2.72	1.79	108	105
262	478	4	0.32	2.10	3.13	2.06	148	145
<hr/>								
272	348	2	0.19	3.53	5.26	3.45	24	23.3
278	382	3	0.26	2.63	3.92	2.57	48.5	46.8
278	382	3	0.34	1.96	2.91	1.91	65.2	64.1
278	422	3	0.33	2.05	3.06	2.01	91.4	88.6
278	422	3	0.41	1.63	2.43	1.60	114	112
282	458	4	0.28	2.45	3.64	2.39	106	104
282	458	4	0.37	1.83	2.72	1.79	141	137
288	512	5	0.32	2.13	3.18	2.09	183	179
<hr/>								
292	368	2	0.17	3.88	5.78	3.79	26.4	25.6
298	402	3	0.25	2.73	4.06	2.67	52.4	50.6
298	402	3	0.33	2.06	3.07	2.02	69	67.9
302	438	4	0.32	2.13	3.18	2.09	97.7	94.6
302	438	4	0.39	1.73	2.58	1.69	120	118
302	478	4	0.26	2.57	3.83	2.51	112	110

Note: Please refer to page B-220 for outer ring oil inlet and oil groove dimensions.

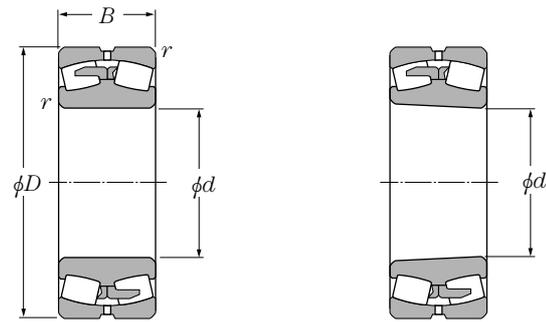

Cylindrical bore

Tapered bore

d 280 ~ 380mm

Boundary dimensions				Basic load ratings				Limiting speeds		Bearing numbers	
mm				dynamic	static	dynamic	static	min ⁻¹		cylindrical bore	tapered ¹⁾ bore
d	D	B	r _{s min} ²⁾	C _r kN	C _{or}	C _r kgf	C _{or}	grease	oil		
280	500	176	5	2 930	5 150	298 000	525 000	610	790	23256B	23256BK
	580	175	6	3 500	5 350	360 000	545 000	600	780	22356B	22356BK
300	420	90	3	1 110	2 320	113 000	237 000	770	1 000	23960	23960K
	460	118	4	1 890	3 550	193 000	365 000	720	940	23060B	23060BK
	460	160	4	2 450	4 950	250 000	505 000	650	840	24060B	24060BK30
	500	160	5	2 750	5 000	280 000	510 000	600	780	23160B	23160BK
	500	200	5	3 300	6 400	340 000	650 000	600	780	24160B	24160BK30
	540	140	5	2 670	4 350	272 000	440 000	720	930	22260B	22260BK
	540	192	5	3 450	6 000	355 000	615 000	560	730	23260B	23260BK
620	185	7.5	3 600	5 400	365 000	550 000	550	720	22360B	22360BK	
320	440	90	3	1 140	2 460	116 000	251 000	720	930	23964	23964K
	480	121	4	1 960	3 850	200 000	395 000	680	880	23064B	23064BK
	480	160	4	2 510	5 200	255 000	530 000	600	780	24064B	24064BK30
	540	176	5	3 100	5 800	320 000	590 000	560	730	23164B	23164BK
	540	218	5	3 850	7 300	390 000	745 000	560	730	24164B	24164BK30
	580	150	5	3 100	5 050	315 000	515 000	660	860	22264B	22264BK
580	208	5	4 000	7 050	410 000	720 000	520	680	23264B	23264BK	
340	460	90	3	1 220	2 650	124 000	270 000	650	870	23968	23968K
	520	133	5	2 310	4 550	235 000	465 000	630	820	23068B	23068BK
	520	180	5	3 000	6 200	305 000	630 000	550	720	24068B	24068BK30
	580	190	5	3 600	6 600	365 000	670 000	520	680	23168B	23168BK
	580	243	5	4 600	8 950	470 000	910 000	520	680	24168B	24168BK30
620	224	6	4 450	8 000	455 000	815 000	490	630	23268B	23268BK	
360	480	90	3	1 320	2 930	135 000	298 000	630	820	23972	23972K
	540	134	5	2 370	4 700	242 000	480 000	590	770	23072B	23072BK
	540	180	5	3 100	6 600	320 000	675 000	520	680	24072B	24072BK30
	600	192	5	3 750	7 050	385 000	715 000	490	630	23172B	23172BK
	600	243	5	4 600	9 150	470 000	935 000	490	630	24172B	24172BK30
	650	232	6	4 850	8 700	495 000	885 000	450	590	23272B	23272BK
380	520	106	4	1 560	3 550	159 000	360 000	590	770	23976	23976K
	560	135	5	2 510	5 150	256 000	525 000	550	720	23076B	23076BK
	560	180	5	3 250	7 100	330 000	725 000	490	640	24076B	24076BK30
	620	194	5	3 900	7 500	400 000	765 000	450	590	23176B	23176BK
	620	243	5	4 800	9 650	490 000	985 000	450	590	24176B	24176BK30

1) Bearings appended with "K" have a tapered bore ratio of 1:12; bearings appended with "K30" have a tapered bore ratio of 1:30.
 2) Smallest allowable dimension for chamfer dimension r.

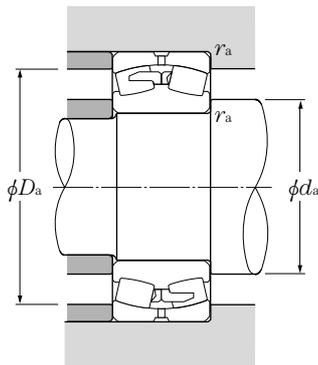

Equivalent radial load
dynamic

$$P_r = XF_r + YF_a$$

$\frac{F_a}{F_r} \leq e$		$\frac{F_a}{F_r} > e$	
X	Y	X	Y
1	Y_1	0.67	Y_2

static

$$P_{or} = F_r + Y_0 F_a$$

For values of e , Y_2 and Y_0 see the table below.

Abutment and fillet dimensions			Constant	Axial load factors			Mass (approx.)	
d_a	D_a	r_{as}	e	Y_1	Y_2	Y_0	cylindrical bore	tapered bore
mm	mm	mm					kg	kg
min	max	max						
302	478	4	0.36	1.90	2.83	1.86	150	145
308	552	5	0.31	2.16	3.22	2.12	224	220
314	406	2.5	0.20	3.34	4.98	3.27	40	38.7
318	442	3	0.25	2.66	3.96	2.60	72.4	70.2
318	442	3	0.34	1.97	2.93	1.92	98	96.4
322	478	4	0.32	2.11	3.15	2.07	131	127
322	478	4	0.40	1.69	2.51	1.65	161	159
322	518	4	0.26	2.57	3.83	2.51	141	138
322	518	4	0.36	1.88	2.79	1.83	193	187
336	584	6	0.32	2.13	3.17	2.08	270	265
334	426	2.5	0.19	3.50	5.21	3.42	43	41.7
338	462	3	0.25	2.73	4.06	2.67	78.2	75.5
338	462	3	0.33	2.06	3.07	2.02	103	101
342	518	4	0.33	2.06	3.07	2.02	167	162
342	518	4	0.40	1.67	2.48	1.63	207	204
342	558	4	0.26	2.57	3.83	2.51	172	168
342	558	4	0.36	1.86	2.77	1.82	243	236
354	446	2.5	0.17	3.91	5.83	3.83	44.7	43.3
362	498	4	0.25	2.68	3.99	2.62	104	100
362	498	4	0.34	1.98	2.95	1.94	140	138
362	558	4	0.33	2.05	3.06	2.01	210	204
362	558	4	0.42	1.61	2.39	1.57	269	265
368	592	5	0.37	1.84	2.75	1.80	300	291
374	466	2.5	0.17	3.99	5.93	3.90	47.2	45.7
382	518	4	0.24	2.78	4.14	2.72	110	106
382	518	4	0.33	2.06	3.07	2.02	147	145
382	578	4	0.32	2.11	3.15	2.07	222	215
382	578	4	0.40	1.67	2.48	1.63	281	277
388	622	5	0.36	1.87	2.78	1.83	339	329
398	502	3	0.19	3.54	5.27	3.46	69.9	67.7
402	538	4	0.24	2.87	4.27	2.80	115	111
402	538	4	0.30	2.23	3.32	2.18	153	150
402	598	4	0.31	2.16	3.22	2.12	235	228
402	598	4	0.39	1.73	2.58	1.69	292	287

Note: Please refer to page B-220 for outer ring oil inlet and oil groove dimensions.

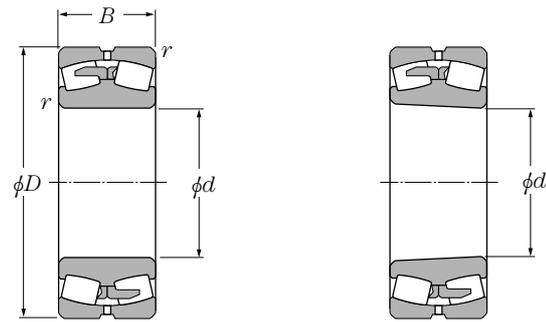

Cylindrical bore

Tapered bore

d 380 ~ 500mm

Boundary dimensions	mm			dynamic kN	Basic load ratings		static kgf	Limiting speeds		Bearing numbers	
	d	D	B		$r_{s\ min}^{(2)}$	dynamic		static	grease	oil	cylindrical bore
380	680	240	6	5 200	9 650	530 000	985 000	430	550	23276B	23276BK
400	540	106	4	1 580	3 650	161 000	370 000	550	720	23980	23980K
	600	148	5	2 980	6 050	305 000	615 000	520	680	23080B	23080BK
	600	200	5	3 850	8 400	390 000	855 000	460	600	24080B	24080BK30
	650	200	6	4 200	8 050	425 000	820 000	430	560	23180B	23180BK
	650	250	6	5 100	10 300	520 000	1 060 000	430	560	24180B	24180BK30
420	720	256	6	5 850	10 600	595 000	1 080 000	400	520	23280B	23280BK
	560	106	4	1 630	3 850	166 000	390 000	530	690	23984	23984K
	620	150	5	3 100	6 400	315 000	650 000	490	640	23084B	23084BK
	620	200	5	3 850	8 450	395 000	865 000	440	570	24084B	24084BK30
	700	224	6	5 200	9 950	530 000	1 020 000	410	530	23184B	23184BK
440	700	280	6	6 150	12 200	625 000	1 240 000	410	530	24184B	24184BK30
	760	272	7.5	6 550	12 000	665 000	1 230 000	380	490	23284B	23284BK
	600	118	4	2 030	4 700	207 000	480 000	500	650	23988	23988K
	650	157	6	3 300	6 850	335 000	695 000	470	610	23088B	23088BK
	650	212	6	4 300	9 450	440 000	960 000	420	540	24088B	24088BK30
460	720	226	6	5 200	10 100	530 000	1 030 000	390	500	23188B	23188BK
	720	280	6	6 450	13 100	660 000	1 330 000	390	500	24188B	24188BK30
	790	280	7.5	6 900	12 800	705 000	1 310 000	360	470	23288B	23288BK
	620	118	4	2 100	4 950	214 000	505 000	480	620	23992	23992K
	680	163	6	3 600	7 450	365 000	760 000	450	580	23092B	23092BK
480	680	218	6	4 600	10 200	470 000	1 040 000	390	510	24092B	24092BK30
	760	240	7.5	5 700	11 400	585 000	1 160 000	360	470	23192B	23192BK
	760	300	7.5	7 100	14 500	725 000	1 480 000	360	470	24192B	24192BK30
	830	296	7.5	7 750	14 500	790 000	1 470 000	340	440	23292B	23292BK
	650	128	5	2 330	5 500	238 000	565 000	450	590	23996	23996K
500	700	165	6	3 650	7 700	370 000	785 000	420	550	23096B	23096BK
	700	218	6	4 650	10 500	475 000	1 070 000	380	490	24096B	24096BK30
	790	248	7.5	6 200	12 300	635 000	1 260 000	350	450	23196B	23196BK
	790	308	7.5	7 450	15 300	760 000	1 560 000	350	450	24196B	24196BK30
	870	310	7.5	8 300	15 500	845 000	1 580 000	320	420	23296B	23296BK
500	670	128	5	2 370	5 600	242 000	570 000	430	560	239/500	239/500K
	720	167	6	3 850	8 300	390 000	845 000	410	530	230/500B	230/500BK

1) Bearings appended with "K" have a tapered bore ratio of 1:12; bearings appended with "K30" have a tapered bore ratio of 1:30.
 2) Smallest allowable dimension for chamfer dimension r.

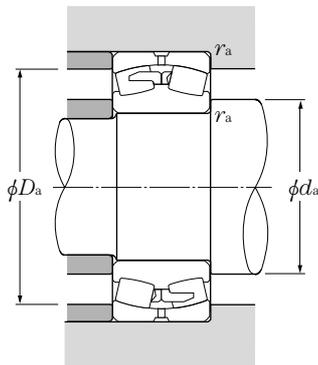

Equivalent radial load
dynamic

$$P_r = XF_r + YF_a$$

$\frac{F_a}{F_r} \leq e$		$\frac{F_a}{F_r} > e$	
X	Y	X	Y
1	Y_1	0.67	Y_2

static

$$P_{or} = F_r + Y_0 F_a$$

For values of e , Y_2 and Y_0 see the table below.

Abutment and fillet dimensions			Constant	Axial load factors			Mass (approx.)	
d_a	D_a	r_{as}	e	Y_1	Y_2	Y_0	cylindrical bore	tapered bore
min	max	max					kg	
408	652	5	0.36	1.89	2.82	1.85	380	369
418	522	3	0.18	3.71	5.53	3.63	73	70.7
422	578	4	0.24	2.80	4.16	2.73	149	144
422	578	4	0.32	2.09	3.11	2.04	202	200
428	622	5	0.31	2.21	3.28	2.16	264	256
428	622	5	0.38	1.77	2.63	1.73	329	324
428	692	5	0.37	1.81	2.69	1.77	457	443
438	542	3	0.17	3.95	5.88	3.86	76.2	73.8
442	598	4	0.24	2.85	4.24	2.78	157	152
442	598	4	0.32	2.13	3.18	2.09	210	207
448	672	5	0.32	2.11	3.15	2.07	354	343
448	672	5	0.40	1.69	2.51	1.65	440	433
456	724	6	0.36	1.86	2.77	1.82	544	528
458	582	3	0.18	3.66	5.46	3.58	101	98
468	622	5	0.24	2.85	4.24	2.78	181	175
468	622	5	0.32	2.11	3.15	2.07	245	241
468	692	5	0.31	2.15	3.21	2.11	370	358
468	692	5	0.39	1.75	2.61	1.71	456	449
476	754	6	0.36	1.88	2.80	1.84	600	582
478	602	3	0.17	3.95	5.88	3.86	107	104
488	652	5	0.23	2.88	4.29	2.82	206	200
488	652	5	0.31	2.15	3.21	2.11	276	272
496	724	6	0.31	2.14	3.19	2.10	443	429
496	724	6	0.39	1.71	2.55	1.67	550	541
496	794	6	0.36	1.87	2.78	1.83	704	683
502	628	4	0.18	3.85	5.73	3.76	123	119
508	672	5	0.23	2.94	4.38	2.88	217	209
508	672	5	0.30	2.22	3.30	2.17	285	280
516	754	6	0.31	2.15	3.21	2.11	492	477
516	754	6	0.39	1.74	2.59	1.70	608	600
516	834	6	0.36	1.87	2.78	1.83	814	790
522	648	4	0.17	4.02	5.98	3.93	131	127
528	692	5	0.23	2.98	4.44	2.91	226	218

Note: Please refer to page B-220 for outer ring oil inlet and oil groove dimensions.

Spherical Roller Bearings

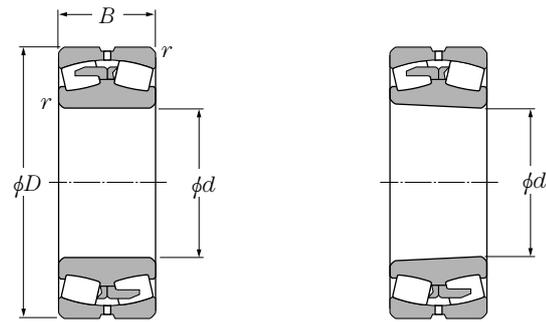

Cylindrical bore

Tapered bore

d 500 ~ 670mm

d	Boundary dimensions			dynamic Cr	Basic load ratings		dynamic Cr	static Cor	Limiting speeds		Bearing numbers	
	D	B	r _{s min} ²⁾		static Cor	static Cor			grease	oil	cylindrical bore	tapered ¹⁾ bore
500	720	218	6	4 750	10 900	485 000	1 110 000	350	460	240/500B	240/500BK30	
	830	264	7.5	6 950	13 700	705 000	1 400 000	330	430	231/500B	231/500BK	
	830	325	7.5	8 050	16 700	825 000	1 700 000	330	430	241/500B	241/500BK30	
	920	336	7.5	9 400	17 800	960 000	1 820 000	310	400	232/500B	232/500BK	
530	710	136	5	2 640	6 450	269 000	655 000	400	520	239/530	239/530K	
	780	185	6	4 400	9 350	445 000	955 000	380	490	230/530B	230/530BK	
	780	250	6	5 600	12 700	570 000	1 290 000	330	430	240/530B	240/530BK30	
	870	272	7.5	7 000	14 200	715 000	1 450 000	310	400	231/530B	231/530BK	
	870	335	7.5	8 300	17 400	850 000	1 770 000	310	400	241/530B	241/530BK30	
	980	355	9.5	10 400	19 800	1 060 000	2 020 000	280	370	232/530B	232/530BK	
560	750	140	5	2 830	6 700	288 000	680 000	380	490	239/560	239/560K	
	820	195	6	4 800	10 500	490 000	1 070 000	350	450	230/560B	230/560BK	
	820	258	6	6 100	14 100	620 000	1 440 000	310	400	240/560B	240/560BK30	
	920	280	7.5	7 650	15 500	780 000	1 580 000	280	370	231/560B	231/560BK	
	920	355	7.5	9 950	20 800	1 010 000	2 120 000	280	370	241/560B	241/560BK30	
	1 030	365	9.5	11 100	21 100	1 130 000	2 150 000	260	340	232/560B	232/560BK	
600	800	150	5	3 150	7 800	325 000	795 000	350	450	239/600	239/600K	
	870	200	6	5 250	12 000	535 000	1 220 000	310	420	230/600B	230/600BK	
	870	272	6	6 450	15 600	655 000	1 590 000	280	370	240/600B	240/600BK30	
	980	300	7.5	9 000	18 400	920 000	1 880 000	260	340	231/600B	231/600BK	
	980	375	7.5	10 700	23 200	1 090 000	2 360 000	260	340	241/600B	241/600BK30	
	1 090	388	9.5	12 200	23 700	1 240 000	2 420 000	250	320	232/600B	232/600BK	
630	850	165	6	3 700	9 250	375 000	945 000	320	420	239/630	239/630K	
	920	212	7.5	5 900	13 000	600 000	1 330 000	310	400	230/630B	230/630BK	
	920	290	7.5	7 550	17 900	770 000	1 830 000	270	350	240/630B	240/630BK30	
	1 030	315	7.5	9 600	19 900	975 000	2 030 000	250	320	231/630B	231/630BK	
	1 030	400	7.5	11 600	25 000	1 180 000	2 550 000	250	320	241/630B	241/630BK30	
	1 150	412	12	13 700	26 800	1 400 000	2 740 000	230	300	232/630B	232/630BK	
670	900	170	6	4 100	10 300	420 000	1 050 000	300	390	239/670	239/670K	
	980	230	7.5	6 550	14 600	665 000	1 490 000	280	360	230/670B	230/670BK	
	980	308	7.5	8 650	20 600	885 000	2 100 000	250	320	240/670B	240/670BK30	
	1 090	336	7.5	11 000	22 800	1 120 000	2 330 000	230	300	231/670B	231/670BK	
	1 090	412	7.5	12 700	28 000	1 300 000	2 850 000	230	300	241/670B	241/670BK30	
	1 220	438	12	16 100	32 000	1 640 000	3 250 000	220	280	232/670B	232/670BK	

1) Bearings appended with "K" have a tapered bore ratio of 1:12; bearings appended with "K30" have a tapered bore ratio of 1:30.

2) Smallest allowable dimension for chamfer dimension r.

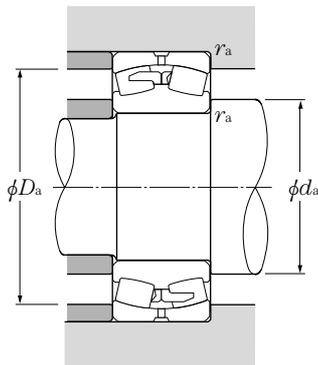

Equivalent radial load
dynamic

$$P_r = XF_r + YF_a$$

$\frac{F_a}{F_r} \leq e$		$\frac{F_a}{F_r} > e$	
X	Y	X	Y
1	Y ₁	0.67	Y ₂

static

$$P_{or} = F_r + Y_0 F_a$$

For values of e , Y_2 and Y_0 see the table below.

Abutment and fillet dimensions			Constant	Axial load factors			Mass (approx.)	
d_a min	D_a max	r_{as} max		e	Y_1	Y_2	Y_0	cylindrical bore kg
528	692	5	0.30	2.28	3.40	2.23	295	290
536	794	6	0.32	2.12	3.16	2.08	584	566
536	794	6	0.39	1.72	2.57	1.69	716	705
536	884	6	0.39	1.74	2.59	1.70	1 000	971
552	688	4	0.17	3.94	5.87	3.86	157	152
558	752	5	0.22	3.03	4.52	2.97	306	295
558	752	5	0.30	2.24	3.33	2.19	413	406
566	834	6	0.30	2.22	3.30	2.17	653	633
566	834	6	0.38	1.79	2.67	1.75	800	788
574	936	8	0.39	1.74	2.59	1.70	1 200	1 170
582	728	4	0.16	4.09	6.09	4.00	182	176
588	792	5	0.22	3.03	4.51	2.96	353	340
588	792	5	0.30	2.29	3.40	2.24	467	459
596	884	6	0.30	2.27	3.38	2.22	752	729
596	884	6	0.39	1.75	2.61	1.71	948	934
604	986	8	0.36	1.88	2.80	1.84	1 360	1 320
622	778	4	0.18	3.85	5.73	3.76	218	211
628	842	5	0.21	3.17	4.72	3.10	400	386
628	842	5	0.29	2.33	3.47	2.28	544	535
636	944	6	0.30	2.22	3.30	2.17	908	880
636	944	6	0.37	1.81	2.70	1.77	1 130	1 110
644	1 046	8	0.36	1.86	2.77	1.82	1 540	1 490
658	822	5	0.18	3.66	5.45	3.58	277	268
666	884	6	0.22	3.14	4.67	3.07	481	464
666	884	6	0.30	2.28	3.40	2.23	657	646
666	994	6	0.30	2.27	3.38	2.22	1 050	1 020
666	994	6	0.38	1.78	2.66	1.74	1 330	1 310
684	1 096	10	0.36	1.87	2.78	1.83	1 900	1 840
698	872	5	0.18	3.76	5.59	3.67	317	307
706	944	6	0.22	3.07	4.57	3.00	594	573
706	944	6	0.29	2.29	3.41	2.24	794	781
706	1 054	6	0.30	2.22	3.30	2.17	1 250	1 210
706	1 054	6	0.37	1.83	2.73	1.79	1 530	1 510
724	1 166	10	0.36	1.89	2.81	1.85	2 270	2 200

Note: Please refer to page B-220 for outer ring oil inlet and oil groove dimensions.

Spherical Roller Bearings

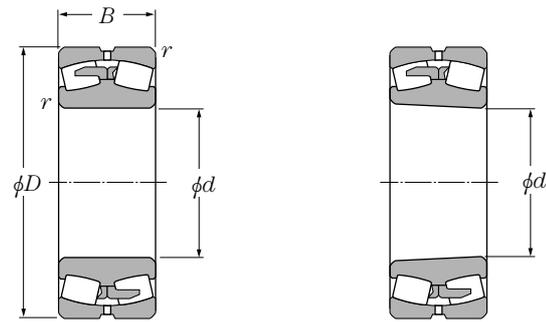

Cylindrical bore

Tapered bore

d 710 ~ 1060mm

Boundary dimensions				Basic load ratings				Limiting speeds		Bearing numbers	
mm				dynamic	static	dynamic	static	min ⁻¹		cylindrical bore	tapered ¹⁾ bore
d	D	B	r _{s min} ²⁾	C _r	C _{or}	C _r	C _{or}	grease	oil		
710	950	180	6	4 450	11 500	450 000	1 170 000	280	370	239/710	239/710K
	1 030	236	7.5	7 200	16 200	730 000	1 650 000	260	340	230/710B	230/710BK
	1 030	315	7.5	9 300	22 500	945 000	2 300 000	230	300	240/710B	240/710BK30
	1 150	345	9.5	11 600	24 900	1 190 000	2 540 000	220	280	231/710B	231/710BK
	1 150	438	9.5	14 500	32 000	1 470 000	3 250 000	220	280	241/710B	241/710BK30
	1 280	450	12	16 300	32 500	1 660 000	3 300 000	200	260	232/710B	232/710BK
750	1 000	185	6	5 000	13 000	510 000	1 330 000	260	340	239/750	239/750K
	1 090	250	7.5	8 150	18 300	835 000	1 860 000	250	320	230/750B	230/750BK
	1 090	335	7.5	10 100	24 600	1 030 000	2 500 000	220	280	240/750B	240/750BK30
	1 220	365	9.5	12 800	27 200	1 310 000	2 780 000	200	260	231/750B	231/750BK
	1 360	475	15	18 200	36 500	1 860 000	3 750 000	180	240	232/750B	232/750BK
800	1 060	195	6	5 400	13 700	550 000	1 400 000	240	310	239/800	239/800K
	1 150	258	7.5	8 400	19 500	860 000	1 990 000	220	290	230/800B	230/800BK
	1 150	345	7.5	11 200	27 800	1 140 000	2 840 000	200	260	240/800B	240/800BK30
	1 280	375	9.5	14 400	31 000	1 460 000	3 150 000	180	240	231/800B	231/800BK
850	1 120	200	6	5 850	15 100	595 000	1 540 000	220	290	239/850	239/850K
	1 220	272	7.5	9 750	22 700	995 000	2 310 000	210	270	230/850B	230/850BK
	1 220	365	7.5	12 500	31 500	1 270 000	3 200 000	180	240	240/850B	240/850BK30
	1 360	400	12	15 500	34 000	1 580 000	3 500 000	170	220	231/850B	231/850BK
900	1 180	206	6	6 650	17 300	675 000	1 770 000	210	270	239/900	239/900K
	1 280	280	7.5	10 300	24 700	1 050 000	2 520 000	190	250	230/900B	230/900BK
	1 280	375	7.5	13 200	33 500	1 350 000	3 450 000	170	220	240/900B	240/900BK30
	1 420	412	12	16 800	38 000	1 720 000	3 850 000	150	200	231/900B	231/900BK
950	1 250	224	7.5	7 750	20 500	790 000	2 090 000	190	250	239/950	239/950K
	1 360	300	7.5	11 500	28 400	1 180 000	2 900 000	180	230	230/950B	230/950BK
	1 360	412	7.5	15 500	40 000	1 580 000	4 100 000	160	210	240/950B	240/950BK30
1000	1 320	236	7.5	8 600	22 700	875 000	2 310 000	180	230	239/1000	239/1000K
	1 420	308	7.5	12 400	30 000	1 260 000	3 050 000	170	220	230/1000B	230/1000BK
	1 420	412	7.5	16 000	42 000	1 640 000	4 250 000	150	190	240/1000B	240/1000BK30
1060	1 400	250	7.5	9 300	24 700	950 000	2 520 000	160	210	239/1060	239/1060K
	1 500	325	9.5	13 600	33 500	1 390 000	3 400 000	150	200	230/1060B	230/1060BK
	1 500	438	9.5	17 800	47 000	1 810 000	4 800 000	140	180	240/1060B	240/1060BK30

1) Bearings appended with "K" have a tapered bore ratio of 1:12; bearings appended with "K30" have a tapered bore ratio of 1:30.

2) Smallest allowable dimension for chamfer dimension r.

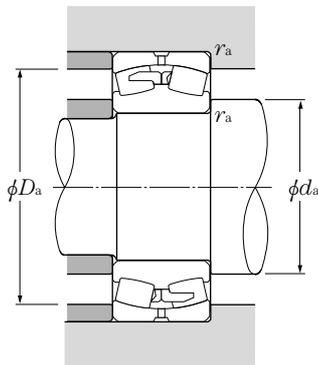

Equivalent radial load
dynamic

$$P_r = XF_r + YF_a$$

$\frac{F_a}{F_r} \leq e$		$\frac{F_a}{F_r} > e$	
X	Y	X	Y
1	Y_1	0.67	Y_2

static

$$P_{or} = F_r + Y_0 F_a$$

For values of e , Y_2 and Y_0 see the table below.

Abutment and fillet dimensions			Constant	Axial load factors			Mass (approx.)	
d_a	D_a	r_{as}	e	Y_1	Y_2	Y_0	cylindrical bore	tapered bore
min	max	max					kg	
738	922	5	0.18	3.85	5.73	3.76	375	363
746	994	6	0.22	3.02	4.50	2.96	663	640
746	994	6	0.29	2.36	3.51	2.31	884	870
754	1 106	8	0.29	2.32	3.45	2.27	1 420	1 380
754	1 106	8	0.37	1.80	2.69	1.76	1 800	1 770
764	1 226	10	0.35	1.91	2.84	1.87	2 540	2 470
778	972	5	0.17	3.90	5.81	3.81	412	399
786	1 054	6	0.21	3.20	4.76	3.13	790	763
786	1 054	6	0.29	2.35	3.49	2.29	1 060	1 040
794	1 176	8	0.29	2.32	3.45	2.27	1 700	1 650
814	1 296	12	0.35	1.92	2.86	1.88	3 050	2 960
828	1 032	5	0.17	4.05	6.04	3.96	487	471
836	1 114	6	0.21	3.15	4.69	3.08	890	859
836	1 114	6	0.28	2.41	3.59	2.36	1 190	1 170
844	1 236	8	0.29	2.32	3.45	2.27	1 890	1 830
878	1 092	5	0.16	4.25	6.32	4.15	550	532
886	1 184	6	0.20	3.32	4.95	3.25	1 050	1 010
886	1 184	6	0.28	2.42	3.61	2.37	1 410	1 390
904	1 306	10	0.28	2.37	3.54	2.32	2 270	2 200
928	1 152	5	0.16	4.32	6.44	4.23	623	603
936	1 244	6	0.20	3.32	4.95	3.25	1 170	1 130
936	1 244	6	0.27	2.48	3.70	2.43	1 570	1 540
954	1 366	10	0.28	2.42	3.60	2.36	2 500	2 420
986	1 214	6	0.16	4.20	6.26	4.11	774	749
986	1 324	6	0.21	3.26	4.85	3.18	1 430	1 380
986	1 324	6	0.28	2.39	3.56	2.34	1 970	1 940
1 036	1 284	6	0.16	4.21	6.26	4.11	916	887
1 036	1 384	6	0.20	3.37	5.02	3.29	1 580	1 520
1 036	1 384	6	0.27	2.51	3.73	2.45	2 110	2 080
1 096	1 364	6	0.16	4.28	6.37	4.19	1 090	1 060
1 104	1 456	8	0.20	3.36	5.00	3.28	1 850	1 790
1 104	1 456	8	0.27	2.49	3.71	2.44	2 450	2 140

Note: Please refer to page B-220 for outer ring oil inlet and oil groove dimensions.

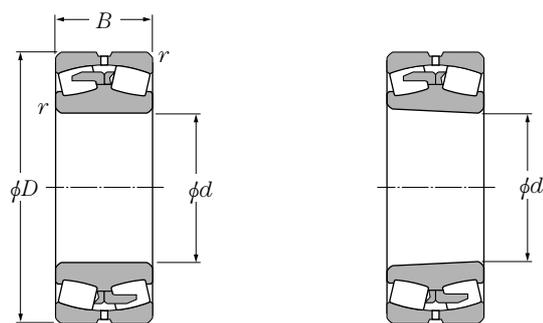

Cylindrical bore

Tapered bore

d 1120 ~ 1400mm

d	Boundary dimensions			dynamic Cr	Basic load ratings		dynamic Cr	static Cor	Limiting speeds		Bearing numbers	
	D	B	rs min ²⁾		static Cor	dynamic Cr			grease	oil	cylindrical bore	tapered ¹⁾ bore
1120	1 460	250	7.5	9 850	26 700	1 000 000	2 720 000	150	200	239/1120	239/1120K	
	1 580	345	9.5	15 600	39 000	1 590 000	4 000 000	150	190	230/1120B	230/1120BK	
	1 580	462	9.5	19 500	52 500	1 990 000	5 350 000	120	160	240/1120B	240/1120BK30	
1180	1 540	272	7.5	11 000	29 800	1 120 000	3 050 000	140	180	239/1180	239/1180K	
1250	1 630	280	7.5	12 100	33 500	1 230 000	3 400 000	120	160	239/1250	239/1250K	
1320	1 720	300	7.5	13 600	38 000	1 390 000	3 900 000	120	150	239/1320	239/1320K	
1400	1 820	315	9.5	15 100	43 000	1 540 000	4 400 000	100	130	239/1400	239/1400K	

1) "K" indicates bearings have tapered bore with a taper ratio of 1: 12.
 2) Smallest allowable dimension for chamfer dimension r.

Spherical Roller Bearings

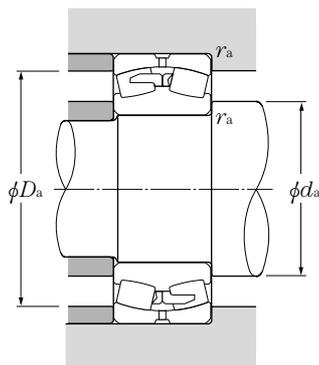

Equivalent radial load

dynamic
 $P_r = XF_r + YF_a$

$\frac{F_a}{F_r} \leq e$		$\frac{F_a}{F_r} > e$	
X	Y	X	Y
1	Y_1	0.67	Y_2

static

$P_{or} = F_r + Y_0 F_a$

For values of e , Y_2 and Y_0 see the table below.

Abutment and fillet dimensions			Constant	Axial load factors			Mass (approx.)	
d_a	D_a	r_{as}	e	Y_1	Y_2	Y_0	cylindrical bore	tapered bore
min	max	max					kg	
1 156	1 424	6	0.15	4.42	6.58	4.32	1 140	1 100
1 164	1 536	8	0.21	3.29	4.80	3.21	2 160	2 090
1 164	1 536	8	0.27	2.50	3.72	2.44	2 890	2 840
1 216	1 504	6	0.15	4.40	6.55	4.30	1 390	1 340
1 286	1 594	6	0.15	4.42	6.58	4.32	1 600	1 550
1 356	1 684	6	0.16	4.34	6.46	4.24	1 900	1 840
1 444	1 776	8	0.15	4.39	6.54	4.29	2 230	2 160

Note: Please refer to page B-220 for outer ring oil inlet and oil groove dimensions.

(For spherical roller bearings)

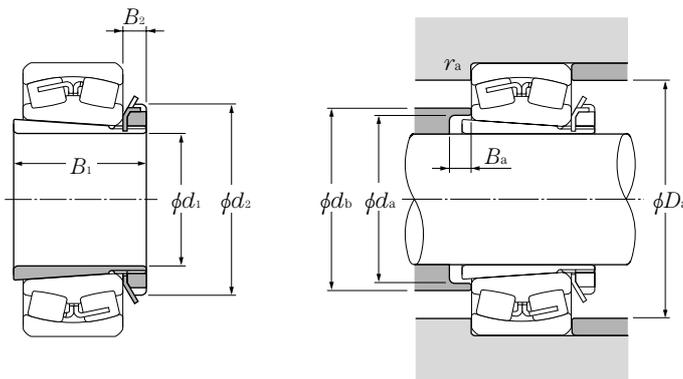

d_1 35 ~ 70mm

Boundary dimensions				Bearing numbers	Abutment and fillet dimensions					Mass ¹⁾	
mm					mm						
d_1	B_1	d_2	B_2	d_a min	d_b max	B_a min	D_a min	D_a max	r_{as} max	kg (approx.)	
35	36	58	10	LH-22208CK;H 308X	44	50	5	—	73	1	0.189
	36	58	10	21308CK;H 308X	44	54	5	—	81.5	1.5	0.189
	46	58	10	22308CK;H2308X	45	52	5	—	81.5	1.5	0.224
40	39	65	11	LH-22209CK;H 309X	49	57	8	—	78	1	0.248
	39	65	11	21309CK;H 309X	49	61	5	—	91.5	1.5	0.248
	50	65	11	22309CK;H2309X	50	58	5	—	91.5	1.5	0.28
45	42	70	12	LH-22210CK;H 310X	54	63	10	—	83	1	0.303
	42	70	12	21310CK;H 310X	54	67	5	—	100	2	0.303
	55	70	12	22310CK;H2310X	56	65	5	—	100	2	0.362
50	45	75	12	LH-22211EK;H 311X	60	67	11	89.5	91.5	1.5	0.345
	45	75	12	LH-22211BK;H 311X	60	67	11	—	91.5	1.5	0.345
	45	75	12	21311K ;H 311X	60	73	6	—	110	2	0.345
	59	75	12	22311BK;H2311X	61	71	6	—	110	2	0.42
55	47	80	13	LH-22212EK;H 312X	65	72	9	98	101.5	1.5	0.394
	47	80	13	LH-22212BK;H 312X	65	72	9	—	101.5	1.5	0.394
	47	80	13	21312K ;H 312X	65	79	5	—	118	2	0.394
	62	80	13	22312BK;H2312X	66	77	5	—	118	2	0.481
60	50	85	14	LH-22213EK;H 313X	70	78.5	8	107	111.5	1.5	0.458
	50	85	14	LH-22213BK;H 313X	70	78.5	9	—	111.5	1.5	0.458
	50	85	14	21313K ;H 313X	70	85	5	—	128	2	0.458
	65	85	14	22313BK;H2313X	72	84	5	—	128	2	0.557
65	55	98	15	LH-22215EK;H 315X	80	89	12	117.5	121.5	1.5	0.831
	55	98	15	LH-22215BK;H 315X	80	89	12	—	121.5	1.5	0.831
	55	98	15	21315K ;H 315X	80	97	5	—	148	2	0.831
	73	98	15	22315BK;H2315X	82	96	5	—	148	2	1.05
70	59	105	17	LH-22216EK;H 316X	86	94.5	12	125.5	130	2	1.03
	59	105	17	LH-22216BK;H 316X	86	94.5	12	—	130	2	1.03
	59	105	17	21316K ;H 316X	86	103	5	—	158	2	1.03
	78	105	17	22316BK;H2316X	87	103	5	—	158	2	1.28

1) Indicates adapter mass.

Note: 1. Please refer to page B-222 to B-225 for bearing dimensions, rated loads, and mass.

2. Please refer to page C-2 to C-10 and C-12 to C-14 for adapter locknut and washer dimensions.

3. Adapter numbers with the suffix "X" signify narrow slit type adapters, and use washers with straight inner tabs.

(For spherical roller bearings)

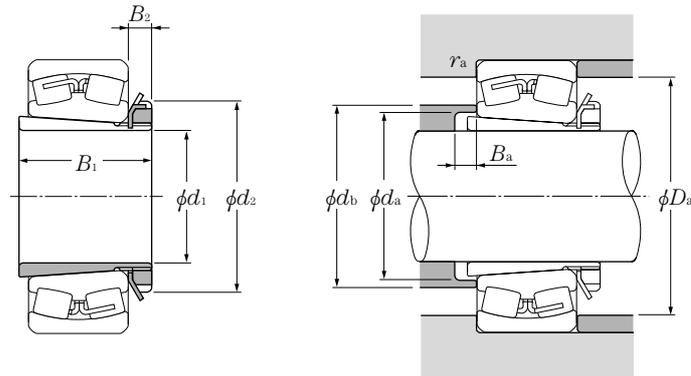

d₁ 75 ~ 115mm

Boundary dimensions				Bearing numbers	Abutment and fillet dimensions					Mass ¹⁾	
mm					mm						
d ₁	B ₁	d ₂	B ₂		d _a min	d _b max	B _a min	D _a min	D _a max	r _{as} max	kg (approx.)
75	63	110	18	LH-22217EK;H 317X	91	100.5	12	135	140	2	1.18
	63	110	18	LH-22217BK;H 317X	91	100.5	12	—	140	2	1.18
	63	110	18	21317K ;H 317X	91	110	6	—	166	2.5	1.18
	82	110	18	22317BK;H2317X	94	110	6	—	166	2.5	1.45
80	65	120	18	LH-22218EK;H 318X	96	107.5	10	144	150	2	1.37
	65	120	18	LH-22218BK;H 318X	96	107.5	10	—	150	2	1.37
	86	120	18	23218BK;H2318X	99	110	18	—	150	2	1.69
	65	120	18	21318K ;H 318X	96	116	6	—	176	2.5	1.37
	86	120	18	22318BK;H2318X	99	117	6	—	176	2.5	1.69
85	68	125	19	22219BK;H 319X	102	117	9	—	158	2	1.56
	68	125	19	21319K ;H 319X	102	123	7	—	186	2.5	1.56
	90	125	19	22319BK;H2319X	105	123	7	—	186	2.5	1.92
90	71	130	20	22220BK;H 320X	107	123	8	—	168	2	1.69
	97	130	20	23220BK;H2320X	110	122	19	—	168	2	2.15
	71	130	20	21320K ;H 320X	107	130	7	—	201	2.5	1.69
	97	130	20	22320BK;H2320X	110	129	7	—	201	2.5	2.15
100	81	145	21	23122BK;H3122X	117	127	7	—	170	2	2.25
	77	145	21	22222BK;H 322X	117	137	6	—	188	2	2.18
	105	145	21	23222BK;H2322X	121	135	17	—	188	2	2.74
	77	145	21	21322K ;H 322X	117	142	9	—	226	2.5	2.18
	105	145	21	22322BK;H2322X	121	142	7	—	226	2.5	2.74
110	72	145	22	23024BK;H3024X	127	136	7	—	170	2	1.93
	88	155	22	23124BK;H3124X	128	140	7	—	190	2	2.64
	88	155	22	22224BK;H3124X	128	150	11	—	203	2	2.64
	112	155	22	23224BK;H2324X	131	147	17	—	203	2	3.19
	112	155	22	22324BK;H2324X	131	154	7	—	246	2.5	3.19
115	80	155	23	23026BK;H3026	137	147	8	—	190	2	2.85
	92	165	23	23126BK;H3126	138	152	8	—	200	2	3.66
	92	165	23	22226BK;H3126	138	161	8	—	216	2.5	3.66
	121	165	23	23226BK;H2326	142	160	21	—	216	2.5	4.6

1) Indicates adapter mass.

Note: 1. Please refer to page B-224 to B-227 for bearing dimensions, rated loads, and mass.

2. Please refer to page C-2 to C-10 and C-12 to C-14 for adapter locknut and washer dimensions.

3. Adapter numbers with the suffix "X" signify narrow slit type adapters, and use washers with straight inner tabs.

(For spherical roller bearings)

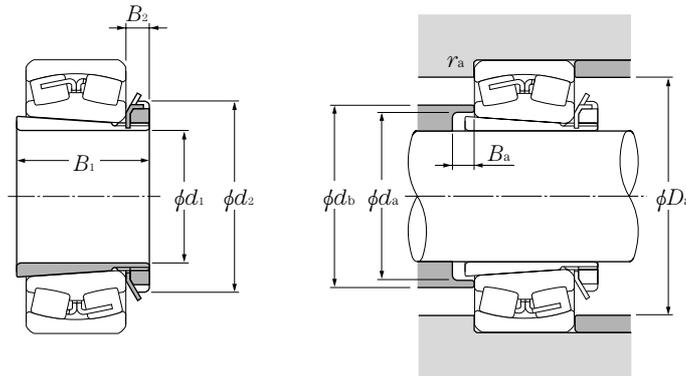

d_1 115 ~ 170mm

	Boundary dimensions				Bearing numbers	Abutment and fillet dimensions					Mass ¹⁾
	mm					mm					
	d_1	B_1	d_2	B_2		d_a min	d_b max	B_a min	D_a max	r_{as} max	kg (approx.)
115	121	165	23		22326BK;H2326	142	167	8	262	3	4.6
125	82	165	24		23028BK;H3028	147	158	8	200	2	3.16
	97	180	24		23128BK;H3128	149	165	8	213	2	4.34
	97	180	24		22228BK;H3128	149	173	8	236	2.5	4.34
	131	180	24		23228BK;H2328	152	172	22	236	2.5	5.55
	131	180	24		22328BK;H2328	152	179	8	282	3	5.55
135	87	180	26		23030BK;H3030	158	170	8	213	2	3.89
	111	195	26		23130BK;H3130	160	178	8	238	2	5.52
	111	195	26		22230BK;H3130	160	188	15	256	2.5	5.52
	139	195	26		23230BK;H2330	163	185	20	256	2.5	6.63
	139	195	26		22330BK;H2330	163	192	8	302	3	6.63
140	93	190	28		23032BK;H3032	168	181	8	228	2	5.21
	119	210	28		23132BK;H3132	170	190	8	258	2	7.67
	119	210	28		22232BK;H3132	170	200	14	276	2.5	7.67
	147	210	28		23232BK;H2332	174	198	18	276	2.5	9.14
	147	210	28		22332BK;H2332	174	205	8	322	3	9.14
150	101	200	29		23034BK;H3034	179	193	8	248	2	5.99
	122	220	29		23134BK;H3134	180	202	8	268	2	8.38
	122	220	29		22234BK;H3134	180	212	10	292	3	8.38
	154	220	29		23234BK;H2334	185	218	18	292	3	10.2
	154	220	29		22334BK;H2334	185	218	8	342	3	10.2
160	109	210	30		23036BK;H3036	189	204	8	268	2	6.83
	131	230	30		23136BK;H3136	191	215	8	286	2.5	9.5
	131	230	30		22236BK;H3136	191	225	18	302	3	9.5
	161	230	30		23236BK;H2336	195	223	22	302	3	11.3
	161	230	30		22336BK;H2336	195	230	8	362	3	11.3
170	112	220	31		23038BK;H3038	199	215	9	278	2	7.45
	141	240	31		23138BK;H3138	202	228	9	306	2.5	10.8
	141	240	31		22238BK;H3138	202	238	21	322	3	10.8
	169	240	31		23238BK;H2338	206	236	21	322	3	12.6
	169	240	31		22338BK;H2338	206	243	9	378	4	12.6

1) Indicates adapter mass.

Note: 1. Please refer to page B-226 to B-229 for bearing dimensions, rated loads, and mass.

2. Please refer to page C-2 to C-10 and C-12 to C-14 for adapter locknut and washer dimensions.

(For spherical roller bearings)

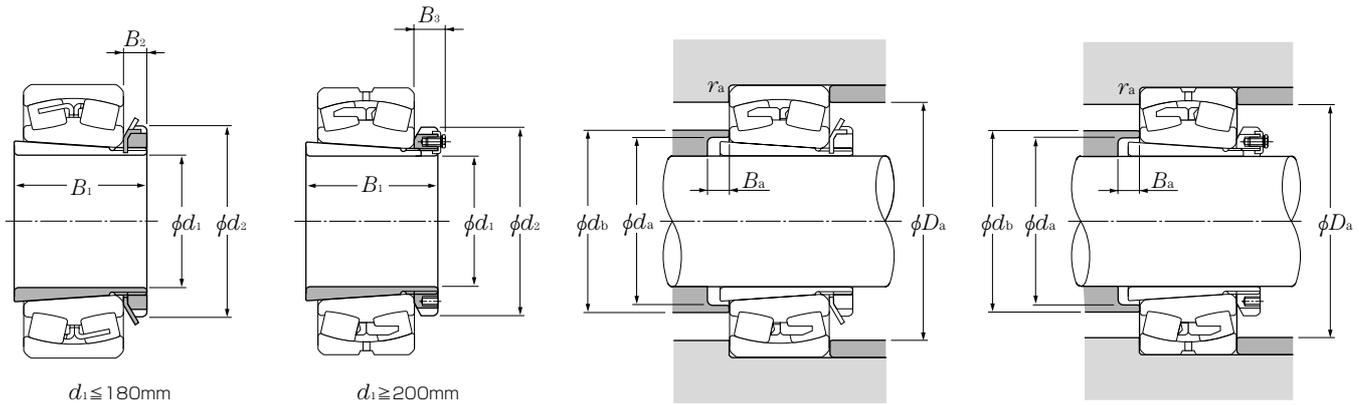

d₁ 180 ~ 300mm

	Boundary dimensions					Bearing numbers	Abutment and fillet dimensions					Mass ¹⁾
	mm						mm					
	d ₁	B ₁	d ₂	B ₂	B ₃		d _a min	d _b max	B _a min	D _a max	r _{as} max	(approx.)
180	120	240	32	—	—	23040BK;H3040	210	227	10	298	2	9.19
	150	250	32	—	—	23140BK;H3140	212	240	10	326	2.5	12.1
	150	250	32	—	—	22240BK;H3140	212	250	24	342	3	12.1
	176	250	32	—	—	23240BK;H2340	216	248	20	342	3	13.9
	176	250	32	—	—	22340BK;H2340	216	255	10	398	4	13.9
200	126	260	—	41	—	23044BK;H3044	231	250	12	326	2.5	10.2
	158	280	—	44	—	23144BK;H3144	233	264	10	352	3	14.7
	158	280	—	44	—	22244BK;H3144	233	274	22	382	3	14.7
	183	280	—	44	—	23244BK;H2344	236	271	11	382	3	16.7
	183	280	—	44	—	22344BK;H2344	236	278	10	438	4	16.7
220	133	290	—	46	—	23048BK;H3048	251	272	11	346	2.5	13.2
	169	300	—	46	—	23148BK;H3148	254	288	11	382	3	17.3
	169	300	—	46	—	22248BK;H3148	254	298	19	422	3	17.3
	196	300	—	46	—	23248BK;H2348	257	295	6	422	3	19.7
	196	300	—	46	—	22348BK;H2348	257	302	11	478	4	19.7
240	145	310	—	46	—	23052BK;H3052	272	295	13	382	3	15.1
	187	330	—	49	—	23152BK;H3152	276	313	11	422	3	22
	187	330	—	49	—	22252BK;H3152	276	323	25	458	4	22
	208	330	—	49	—	23252BK;H2352	278	319	2	458	4	24.2
	208	330	—	49	—	22352BK;H2352	278	326	11	512	5	24.2
260	152	330	—	50	—	23056BK;H3056	292	317	12	402	3	17.7
	192	350	—	51	—	23156BK;H3156	296	336	12	438	4	24.5
	192	350	—	51	—	22256BK;H3156	296	346	28	478	4	24.5
	221	350	—	51	—	23256BK;H2356	299	343	11	478	4	27.8
	221	350	—	51	—	22356BK;H2356	299	350	12	552	5	27.8
280	168	360	—	54	—	23060BK;H3060	313	340	12	442	3	22.8
	208	380	—	53	—	23160BK;H3160	317	361	12	478	4	30.2
	208	380	—	53	—	22260BK;H3160	317	371	32	518	4	30.2
	240	380	—	53	—	23260BK;H3260	321	368	12	518	4	34.1
300	171	380	—	55	—	23064BK;H3064	334	363	13	462	3	24.6
	226	400	—	56	—	23164BK;H3164	339	384	13	518	4	34.9
	226	400	—	56	—	22264BK;H3164	339	394	39	558	4	34.9

1) Indicates adapter mass.

Note: 1. Please refer to page B-228 to B-233 for bearing dimensions, rated loads, and mass.

2. Please refer to page C-2 to C-10 and C-12 to C-14 for adapter locknut and washer dimensions.

(For spherical roller bearings)

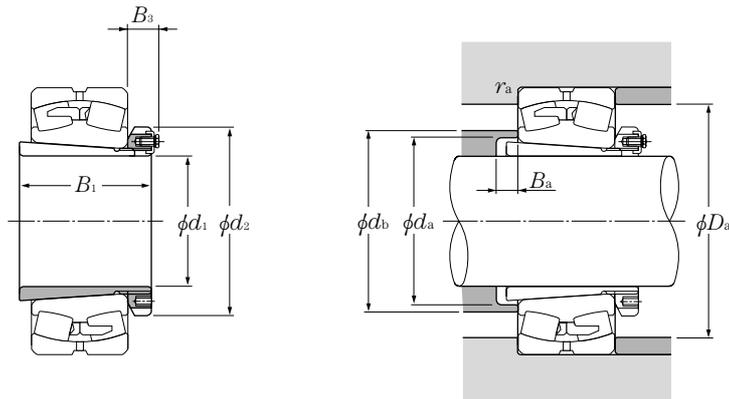

d₁ 300 ~ 470mm

Boundary dimensions				Bearing numbers	Abutment and fillet dimensions					Mass ¹⁾
mm					mm					
d ₁	B ₁	d ₂	B ₃	d _a min	d _b max	B _a min	D _a max	r _{as} max	kg (approx.)	
300	258	400	56	23264BK;H3264	343	393	13	558	4	39.3
320	187	400	58	23068BK;H3068	355	386	14	498	4	28.7
	254	440	72	23168BK;H3168	360	409	14	558	4	49.5
	288	440	72	23268BK;H3268	364	421	14	592	5	54.6
340	188	420	58	23072BK;H3072	375	408	14	518	4	30.5
	259	460	75	23172BK;H3172	380	432	14	578	4	54.2
	299	460	75	23272BK;H3272	385	442	14	622	5	60.2
360	193	450	62	23076BK;H3076	396	431	15	538	4	35.8
	264	490	77	23176BK;H3176	401	456	15	598	4	61.7
	310	490	77	23276BK;H3276	405	465	15	652	5	69.6
380	210	470	66	23080BK;H3080	417	454	15	578	4	41.3
	272	520	82	23180BK;H3180	421	479	15	622	5	70.6
	328	520	82	23280BK;H3280	427	488	15	692	5	81
400	212	490	66	23084BK;H3084	437	476	16	598	4	43.7
	304	540	90	23184BK;H3184	443	504	16	672	5	84.2
	352	540	90	23284BK;H3284	448	515	16	724	6	94
410	228	520	77	23088BK;H3088	458	499	17	622	5	65.2
	307	560	90	23188BK;H3188	464	527	17	692	5	104
	361	560	90	23288BK;H3288	469	539	17	754	6	118
430	234	540	77	23092BK;H3092	478	521	17	652	5	69.5
	326	580	95	23192BK;H3192	485	551	17	724	6	116
	382	580	95	23292BK;H3292	491	563	17	794	6	132
450	237	560	77	23096BK;H3096	499	544	18	672	5	73.3
	335	620	95	23196BK;H3196	505	575	18	754	6	133
	397	620	95	23296BK;H3296	512	590	18	834	6	152
470	247	580	85	230/500BK;H30/500	519	566	18	692	5	81.8
	356	630	100	231/500BK;H31/500	527	600	18	794	6	143
	428	630	100	232/500BK;H32/500	534	618	18	884	6	166

1) Indicates adapter mass.

Note: 1. Please refer to page B-228 to B-237 for bearing dimensions, rated loads, and mass.

2. Please refer to page C-2 to C-10 and C-12 to C-14 for adapter locknut and washer dimensions.

Withdrawal Sleeves

(For spherical roller bearings)

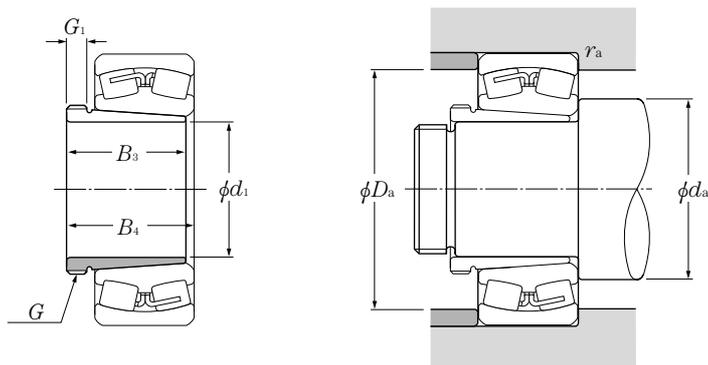

d₁ 35 ~ 70mm

d ₁	Boundary dimensions				Bearing numbers	Abutment and fillet dimensions					Mass ⁽³⁾ kg (approx.)	Appro- ⁽⁴⁾ priate nut no.
	mm thread ⁽¹⁾ G	B ₃	G ₁	B ₄ ⁽²⁾		d _a		D _a		r _{as}		
					min	max	min	max	max			
35	M45 × 1.5	29	6	32	LH-22208CK ;AH 308	47	—	—	73	1	0.09	AN09
	M45 × 1.5	29	6	32	21308CK ;AH 308	48.5	—	—	81.5	1.5	0.09	AN09
	M45 × 1.5	40	7	43	22308CK ;AH 2308	48.5	—	—	81.5	1.5	0.128	AN09
40	M50 × 1.5	31	6	34	LH-22209CK ;AH 309	52	—	—	78	1	0.109	AN10
	M50 × 1.5	31	6	34	21309CK ;AH 309	53.5	—	—	91.5	1.5	0.109	AN10
	M50 × 1.5	44	7	47	22309CK ;AH 2309	53.5	—	—	91.5	1.5	0.164	AN10
45	M55 × 2	35	7	38	LH-22210CK ;AHX 310	57	—	—	83	1	0.137	AN11
	M55 × 2	35	7	38	21310CK ;AHX 310	60	—	—	100	2	0.137	AN11
	M55 × 2	50	9	53	22310CK ;AHX 2310	60	—	—	100	2	0.209	AN11
50	M60 × 2	37	7	40	LH-22211EK ;AHX 311	63.5	67	89.5	91.5	1.5	0.161	AN12
	M60 × 2	37	7	40	LH-22211BK ;AHX 311	63.5	—	—	91.5	1.5	0.161	AN12
	M60 × 2	37	7	40	21311K ;AHX 311	65	—	—	110	2	0.161	AN12
	M60 × 2	54	10	57	22311BK ;AHX 2311	65	—	—	110	2	0.253	AN12
55	M65 × 2	40	8	43	LH-22212EK ;AHX 312	68.5	72	98	101.5	1.5	0.189	AN13
	M65 × 2	40	8	43	LH-22212BK ;AHX 312	68.5	—	—	101.5	1.5	0.189	AN13
	M65 × 2	40	8	43	21312K ;AHX 312	72	—	—	118	2	0.189	AN13
	M65 × 2	58	11	61	22312BK ;AHX 2312	72	—	—	118	2	0.297	AN13
60	M75 × 2	42	8	45	LH-22213EK ;AH 313	73.5	78.5	107	111.5	1.5	0.253	AN15
	M75 × 2	42	8	45	LH-22213BK ;AH 313	73.5	—	—	111.5	1.5	0.253	AN15
	M75 × 2	42	8	45	21313K ;AH 313	77	—	—	128	2	0.253	AN15
	M75 × 2	61	12	64	22313BK ;AH 2313	77	—	—	128	2	0.395	AN15
65	M80 × 2	43	8	47	LH-22214EK ;AH 314	78.5	83.5	112.5	116.5	1.5	0.28	AN16
	M80 × 2	43	8	47	LH-22214BK ;AH 314	78.5	—	—	116.5	1.5	0.28	AN16
	M80 × 2	43	8	47	21314K ;AH 314	82	—	—	138	2	0.28	AN16
	M80 × 2	64	12	68	22314BK ;AHX 2314	82	—	—	138	2	0.466	AN16
70	M85 × 2	45	8	49	LH-22215EK ;AH 315	83.5	89	117.5	121.5	1.5	0.313	AN17
	M85 × 2	45	8	49	LH-22215BK ;AH 315	83.5	—	—	121.5	1.5	0.313	AN17
	M85 × 2	45	8	49	21315K ;AH 315	87	—	—	148	2	0.313	AN17
	M85 × 2	68	12	72	22315BK ;AHX 2315	87	—	—	148	2	0.534	AN17

1) Standard thread shapes and dimensions are as per JIS B0207 (metric thread).

2) Indicates reference dimensions before attachment of withdrawal sleeve.

3) Indicates withdrawal sleeve mass.

4) Indicates number of nut to be used at time of disassembly. See pages C-2 to C-10 for nut dimensions.

Note: 1. Please refer to page B-222, B-225 for bearing dimensions, rated loads, and mass.

Withdrawal Sleeves

(For spherical roller bearings)

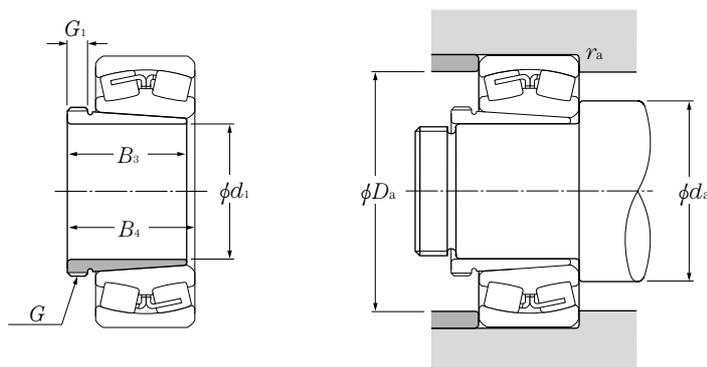

d_1 75 ~ 115mm

d_1	Boundary dimensions				Bearing numbers	Abutment and fillet dimensions					Mass ³⁾ kg (approx.)	Appro- ⁴⁾ priate nut no.
	mm					mm						
	thread ¹⁾ G	B_3	G_1	B_4 ²⁾		d_a min	d_a max	D_a min	D_a max	r_{as} max		
75	M90 × 2	48	8	52	LH-22216EK;AH 316	90	94.5	125.5	130	2	0.365	AN18
	M90 × 2	48	8	52	LH-22216BK;AH 316	90	—	—	130	2	0.365	AN18
	M90 × 2	48	8	52	21316K ;AH 316	92	—	—	158	2	0.365	AN18
	M90 × 2	71	12	75	22316BK;AHX 2316	92	—	—	158	2	0.597	AN18
80	M95 × 2	52	9	56	LH-22217EK;AHX 317	95	100.5	135	140	2	0.429	AN19
	M95 × 2	52	9	56	LH-22217BK;AHX 317	95	—	—	140	2	0.429	AN19
	M95 × 2	52	9	56	21317K ;AHX 317	99	—	—	166	2.5	0.429	AN19
	M95 × 2	74	13	78	22317BK;AHX 2317	99	—	—	166	2.5	0.67	AN19
85	M100 × 2	53	9	57	LH-22218EK;AHX 318	100	107.5	144	150	2	0.461	AN20
	M100 × 2	53	9	57	LH-22218BK;AHX 318	100	—	—	150	2	0.461	AN20
	M100 × 2	63	10	67	23218BK;AHX 3218	100	—	—	150	2	0.576	AN20
	M100 × 2	53	9	57	21318K ;AHX 318	104	—	—	176	2.5	0.461	AN20
	M100 × 2	79	14	83	22318BK;AHX 2318	104	—	—	176	2.5	0.779	AN20
90	M105 × 2	57	10	61	22219BK;AHX 319	107	—	—	158	2	0.532	AN21
	M105 × 2	57	10	61	21319K ;AHX 319	109	—	—	186	2.5	0.532	AN21
	M105 × 2	85	16	89	22319BK;AHX 2319	109	—	—	186	2.5	0.886	AN21
95	M110 × 2	59	10	63	22220BK;AHX 320	112	—	—	168	2	0.582	AN22
	M110 × 2	73	11	77	23220BK;AHX 3220	112	—	—	168	2	0.767	AN22
	M110 × 2	59	10	63	21320K ;AHX 320	114	—	—	201	2.5	0.582	AN22
	M110 × 2	90	16	94	22320BK;AHX 2320	114	—	—	201	2.5	0.998	AN22
105	M120 × 2	68	11	72	23122BK ;AHX 3122	120	—	—	170	2	0.76	AN24
	M115 × 2	82	13	91	24122BK30 ;AH 24122	120	—	—	170	2	0.73	AN23
	M120 × 2	68	11	72	22222BK ;AHX 3122	122	—	—	188	2	0.76	AN24
	M125 × 2	82	11	86	23222BK ;AHX 3222	122	—	—	188	2	1.04	AN25
	M120 × 2	63	12	67	21322K ;AHX 322	124	—	—	226	2.5	0.663	AN24
	M125 × 2	98	16	102	22322BK ;AHX 2322	124	—	—	226	2.5	1.35	AN25
115	M130 × 2	60	13	64	23024BK ;AHX 3024	130	—	—	170	2	0.75	AN26
	M125 × 2	73	13	82	24024BK30 ;AH 24024	130	—	—	170	2	0.65	AN25
	M125 × 2	73	13	82	24024CK30 ;AH 24024	130	—	—	170	2	0.65	AN25
	M130 × 2	75	12	79	23124BK ;AHX 3124	130	—	—	190	2	0.95	AN26

1) Standard thread shapes and dimensions are as per JIS B0207 (metric thread).

2) Indicates reference dimensions before attachment of withdrawal sleeve.

3) Indicates withdrawal sleeve mass.

4) Indicates number of nut to be used at time of disassembly. See pages C-2 to C-10 for nut dimensions.

Note: 1. Please refer to page B-224, B-227 for bearing dimensions, rated loads, and mass.

Withdrawal Sleeves

(For spherical roller bearings)

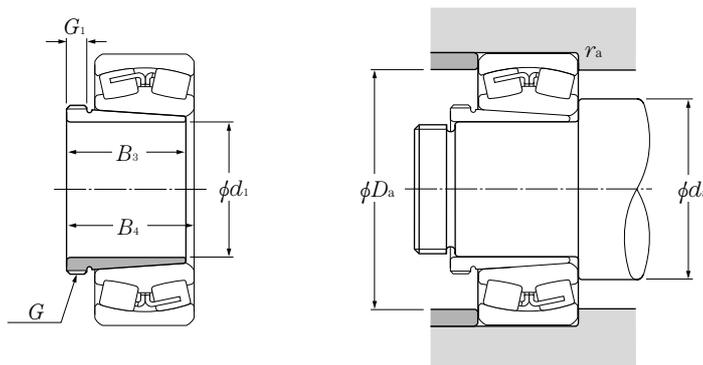

d_1 115 ~ 150mm

	Boundary dimensions				Bearing numbers	Abutment and fillet dimensions			Mass ³⁾ kg (approx.)	Appro ⁴⁾ nut no.
	d_1	thread ¹⁾ G	mm B_3	G_1		B_4 ²⁾	d_a min	mm D_a max		
115	M130 × 2	93	13	102	24124BK30 ; AH 24124	130	190	2	1	AN26
	M130 × 2	75	12	79	22224BK ; AHX 3124	132	203	2	0.95	AN26
	M135 × 2	90	13	94	23224BK ; AHX 3224	132	203	2	1.3	AN27
	M135 × 2	105	17	109	22324BK ; AHX 2324	134	246	2.5	1.6	AN27
125	M140 × 2	67	14	71	23026BK ; AHX 3026	140	190	2	0.93	AN28
	M135 × 2	83	14	93	24026BK30 ; AH 24026	140	190	2	0.84	AN27
	M135 × 2	83	14	93	24026CK30 ; AH 24026	140	190	2	0.84	AN27
	M140 × 2	78	12	82	23126BK ; AHX 3126	140	200	2	1.08	AN28
	M140 × 2	94	14	104	24126BK30 ; AH 24126	140	200	2	1.11	AN28
	M140 × 2	78	12	82	22226BK ; AHX 3126	144	216	2.5	1.08	AN28
	M145 × 2	98	15	102	23226BK ; AHX 3226	144	216	2.5	1.58	AN29
	M145 × 2	115	19	119	22326BK ; AHX 2326	148	262	3	1.97	AN29
135	M150 × 2	68	14	73	23028BK ; AHX 3028	150	200	2	1.01	AN30
	M145 × 2	83	14	93	24028BK30 ; AH 24028	150	200	2	0.91	AN29
	M145 × 2	83	14	93	24028CK30 ; AH 24028	150	200	2	0.91	AN29
	M150 × 2	83	14	88	23128BK ; AHX 3128	152	213	2	1.28	AN30
	M150 × 2	99	14	109	24128BK30 ; AH 24128	152	213	2	1.25	AN30
	M150 × 2	83	14	88	22228BK ; AHX 3128	154	236	2.5	1.28	AN30
	M155 × 3	104	15	109	23228BK ; AHX 3228	154	236	2.5	1.84	AN31
	M155 × 3	125	20	130	22328BK ; AHX 2328	158	282	3	2.33	AN31
145	M160 × 3	72	15	77	23030BK ; AHX 3030	162	213	2	1.15	AN32
	M155 × 3	90	15	101	24030BK30 ; AH 24030	162	213	2	1.04	AN31
	M155 × 3	90	15	101	24030CK30 ; AH 24030	162	213	2	1.04	AN31
	M165 × 3	96	15	101	23130BK ; AHX 3130	162	238	2	1.79	AN33
	M160 × 3	115	15	126	24130BK30 ; AH 24130	162	238	2	1.56	AN32
	M165 × 3	96	15	101	22230BK ; AHX 3130	164	256	2.5	1.79	AN33
	M165 × 3	114	17	119	23230BK ; AHX 3230	164	256	2.5	2.22	AN33
	M165 × 3	135	24	140	22330BK ; AHX 2330	168	302	3	2.82	AN33
150	M170 × 3	77	16	82	23032BK ; AH 3032	172	228	2	2.06	AN34
	M170 × 3	95	15	106	24032BK30 ; AH 24032	172	228	2	2.33	AN34
	M170 × 3	95	15	106	24032CK30 ; AH 24032	172	228	2	2.33	AN34
	M180 × 3	103	16	108	23132BK ; AH 3132	172	258	2	3.21	AN36

1) Standard thread shapes and dimensions are as per JIS B0207 (metric thread).

2) Indicates reference dimensions before attachment of withdrawal sleeve.

3) Indicates withdrawal sleeve mass.

4) Indicates number of nut to be used at time of disassembly. See pages C-2 to C-10 for nut dimensions.

Note: 1. Please refer to page B-226, B-229 for bearing dimensions, rated loads, and mass.

(For spherical roller bearings)

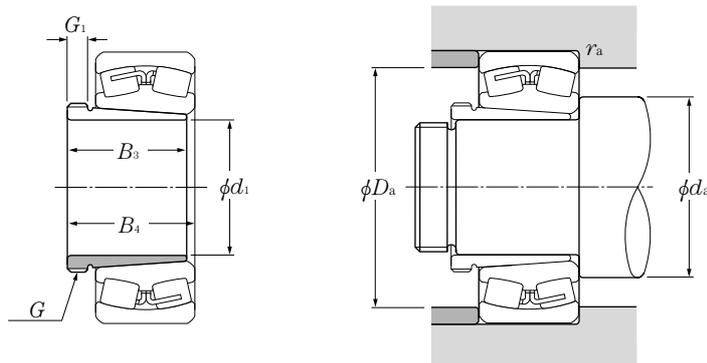

d_1 150 ~ 190mm

d_1	Boundary dimensions				Bearing numbers	Abutment and fillet dimensions			Mass ³⁾ kg (approx.)	Appro- ⁴⁾ priate nut no.
	thread ¹⁾ G	mm		$B_4^{2)}$		d_a min	D_a max	r_{as} max		
150	M170 × 3	124	15	135	24132BK30 ;AH 24132	172	258	2	3	AN34
	M180 × 3	103	16	108	22232BK ;AH 3132	174	276	2.5	3.21	AN36
	M180 × 3	124	20	130	23232BK ;AH 3232	174	276	2.5	4.08	AN36
	M180 × 3	140	24	146	22332BK ;AH 2332	178	322	3	4.72	AN36
160	M180 × 3	85	17	90	23034BK ;AH 3034	182	248	2	2.43	AN36
	M180 × 3	106	16	117	24034BK30 ;AH 24034	182	248	2	2.8	AN36
	M180 × 3	106	16	117	24034CK30 ;AH 24034	182	248	2	2.8	AN36
	M190 × 3	104	16	109	23134BK ;AH 3134	182	268	2	3.4	AN38
	M180 × 3	125	16	136	24134BK30 ;AH 24134	182	268	2	3.21	AN36
	M190 × 3	104	16	109	22234BK ;AH 3134	188	292	3	3.4	AN38
	M190 × 3	134	24	140	23234BK ;AH 3234	188	292	3	4.8	AN38
	M190 × 3	146	24	152	22334BK ;AH 2334	188	342	3	5.25	AN38
170	M190 × 3	92	17	98	23036BK ;AH 3036	192	268	2	2.81	AN38
	M190 × 3	116	16	127	24036BK30 ;AH 24036	192	268	2	3.1	AN38
	M190 × 3	116	16	127	24036CK30 ;AH 24036	192	268	2	3.1	AN38
	M200 × 3	116	19	122	23136BK ;AH 3136	194	286	2.5	4.22	AN40
	M190 × 3	134	16	145	24136BK30 ;AH 24136	194	286	2.5	3.68	AN38
	M200 × 3	105	17	110	22236BK ;AH 2236	198	302	3	3.73	AN40
	M200 × 3	140	24	146	23236BK ;AH 3236	198	302	3	5.32	AN40
	M200 × 3	154	26	160	22336BK ;AH 2336	198	362	3	5.83	AN40
180	Tr205 × 4	96	18	102	23038BK ;AH 3038	202	278	2	3.32	HNL41
	M200 × 3	118	18	131	24038BK30 ;AH 24038	202	278	2	3.5	AN40
	M200 × 3	118	18	131	24038CK30 ;AH 24038	202	278	2	3.5	AN40
	Tr210 × 4	125	20	131	23138BK ;AH 3138	204	306	2.5	4.89	HN42
	M200 × 3	146	18	159	24138BK30 ;AH 24138	204	306	2.5	4.28	AN40
	Tr210 × 4	112	18	117	22238BK ;AH 2238	208	322	3	4.25	HN42
	Tr210 × 4	145	25	152	23238BK ;AH 3238	208	322	3	5.9	HN42
	Tr210 × 4	160	26	167	22338BK ;AH 2338	212	378	4	6.63	HN42
190	Tr215 × 4	102	19	108	23040BK ;AH 3040	212	298	2	3.8	HNL43
	Tr210 × 4	127	18	140	24040BK30 ;AH 24040	212	298	2	3.93	HN42
	Tr220 × 4	134	21	140	23140BK ;AH 3140	214	326	2.5	5.49	HN44
	Tr210 × 4	158	18	171	24140BK30 ;AH 24140	214	326	2.5	5.1	HN42

1) Standard thread shapes and dimensions are as per JIS B0207 (metric thread).
 2) Indicates reference dimensions before attachment of withdrawal sleeve.
 3) Indicates withdrawal sleeve mass.
 4) Indicates number of nut to be used at time of disassembly. See pages C-2 to C-10 for nut dimensions.
 Note: 1. Please refer to page B-228, B-231 for bearing dimensions, rated loads, and mass.

Withdrawal Sleeves

(For spherical roller bearings)

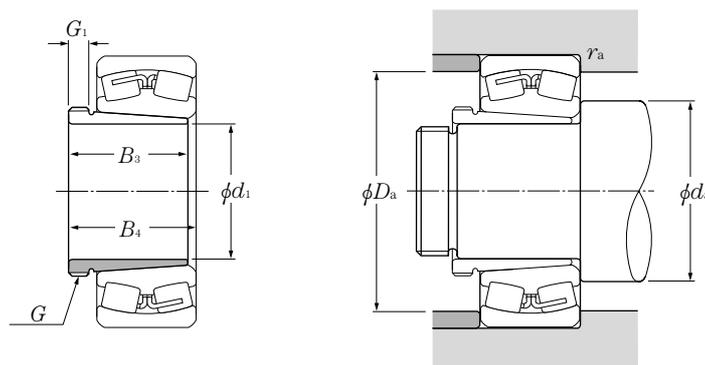

d₁ 190 ~ 260mm

d ₁	Boundary dimensions				Bearing numbers	Abutment and fillet dimensions			Mass ³⁾ kg (approx.)	Appro- ⁴⁾ priate nut no.
	thread ¹⁾ G	mm				d _a min	D _a max	r _{as} max		
		B ₃	G ₁	B ₄ ²⁾						
190	Tr220 × 4	118	19	123	22240BK ;AH 2240	218	342	3	4.68	HN44
	Tr220 × 4	153	25	160	23240BK ;AH 3240	218	342	3	6.68	HN44
	Tr220 × 4	170	30	177	22340BK ;AH 2340	222	398	4	7.54	HN44
200	Tr235 × 4	111	20	117	23044BK ;AH 3044	234	326	2.5	7.4	HNL47
	Tr230 × 4	138	20	152	24044BK30 ;AH 24044H	234	326	2.5	8.25	HN46
	Tr240 × 4	145	23	151	23144BK ;AH 3144	238	352	3	10.4	HN48
	Tr230 × 4	170	20	184	24144BK30 ;AH 24144H	238	352	3	10.2	HN46
	Tr240 × 4	130	20	136	22244BK ;AH 2244	238	382	3	9.1	HN48
	Tr240 × 4	181	30	189	23244BK ;AH 2344	238	382	3	13.5	HN48
	Tr240 × 4	181	30	189	22344BK ;AH 2344	242	438	4	13.5	HN48
220	Tr260 × 4	116	21	123	23048BK ;AH 3048	254	346	2.5	8.75	HNL52
	Tr250 × 4	138	20	153	24048BK30 ;AH 24048H	254	346	2.5	8.98	HN50
	Tr260 × 4	154	25	161	23148BK ;AH 3148	258	382	3	12	HN52
	Tr260 × 4	180	20	195	24148BK30 ;AH 24148H	258	382	3	12.5	HN52
	Tr260 × 4	144	21	150	22248BK ;AH 2248	258	422	3	11.1	HN52
	Tr260 × 4	189	30	197	23248BK ;AH 2348	258	422	3	15.5	HN52
	Tr260 × 4	189	30	197	22348BK ;AH 2348	262	478	4	15.5	HN52
240	Tr280 × 4	128	23	135	23052BK ;AH 3052	278	382	3	10.7	HNL56
	Tr270 × 4	162	22	178	24052BK30 ;AH 24052	278	382	3	11.8	HN54
	Tr290 × 4	172	26	179	23152BK ;AH 3152	278	422	3	16.2	HN58
	Tr280 × 4	202	22	218	24152BK30 ;AH 24152H	278	422	3	15.4	HN56
	Tr290 × 4	155	23	161	22252BK ;AH 2252	282	458	4	14	HN58
	Tr290 × 4	205	30	213	23252BK ;AH 2352	282	458	4	19.6	HN58
	Tr290 × 4	205	30	213	22352BK ;AH 2352	288	512	5	19.6	HN58
260	Tr300 × 4	131	24	139	23056BK ;AH 3056	298	402	3	12	HNL60
	Tr290 × 4	162	22	179	24056BK30 ;AH 24056H	298	402	3	12.8	HN58
	Tr310 × 5	175	28	183	23156BK ;AH 3156	302	438	4	17.5	HN62
	Tr300 × 4	202	22	219	24156BK30 ;AH 24156H	302	438	4	16.3	HN60
	Tr310 × 5	155	24	163	22256BK ;AH 2256	302	478	4	15.2	HN62
	Tr310 × 5	212	30	220	23256BK ;AH 2356	302	478	4	21.6	HN62
	Tr310 × 5	212	30	220	22356BK ;AH 2356	308	552	5	21.6	HN62

1) Standard thread shapes and dimensions are as per JIS B0207 (metric thread).

2) Indicates reference dimensions before attachment of withdrawal sleeve.

3) Indicates withdrawal sleeve mass.

4) Indicates number of nut to be used at time of disassembly. See pages C-2 to C-10 for nut dimensions.

Note: 1. Please refer to page B-230, B-233 for bearing dimensions, rated loads, and mass.

2. Withdrawal sleeve numbers appended with the suffix "H" signify high pressure oil (hydraulic) design. (See page B-213)

Withdrawal Sleeves

(For spherical roller bearings)

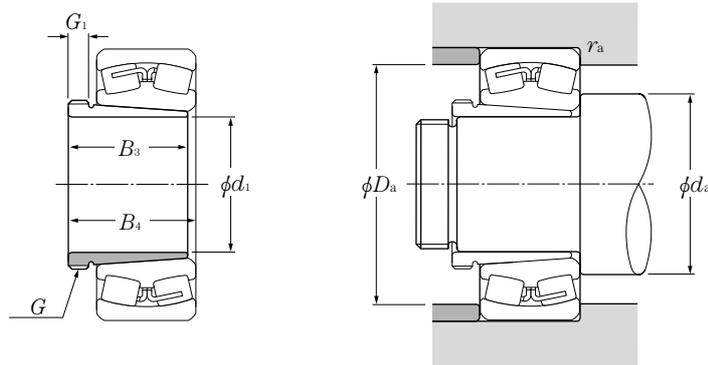

d_1 280 ~ 400mm

d_1	Boundary dimensions				Bearing numbers	Abutment and fillet dimensions			Mass ³⁾ kg (approx.)	Appro- ⁴⁾ priate nut no.
	thread ¹⁾ G	mm		$B_4^{2)}$		d_a min	D_a max	r_{as} max		
280	Tr320 × 5	145	26	153	23060BK ;AH 3060	318	442	3	14.4	HNL64
	Tr310 × 5	184	24	202	24060BK30 ;AH 24060H	318	442	3	15.5	HN62
	Tr330 × 5	192	30	200	23160BK ;AH 3160	322	478	4	20.8	HN66
	Tr320 × 5	224	24	242	24160BK30 ;AH 24160H	322	478	4	19.5	HN64
	Tr330 × 5	170	26	178	22260B ;AH 2260	322	518	4	18.1	HN66
	Tr330 × 5	228	34	236	23260BK ;AH 3260	322	518	4	26	HN66
300	Tr345 × 5	149	27	157	23064BK ;AH 3064	338	462	3	16	HNL69
	Tr330 × 5	184	24	202	24064BK30 ;AH 24064H	338	462	3	16.6	HN66
	Tr350 × 5	209	31	217	23164BK ;AH 3164	342	518	4	24.5	HN70
	Tr340 × 5	242	24	260	24164BK30 ;AH 24164H	342	518	4	21.4	HN68
	Tr350 × 5	180	27	190	22264BK ;AH 2264	342	558	4	20.2	HN70
	Tr350 × 5	246	36	254	23264BK ;AH 3264	342	558	4	30.6	HN70
320	Tr365 × 5	162	28	171	23068BK ;AH 3068	362	498	4	19.5	HN73
	Tr360 × 5	206	26	225	24068BK30 ;AH 24068H	362	498	4	21.7	HNL72
	Tr370 × 5	225	33	234	23168BK ;AH 3168	362	558	4	29	HN74
	Tr360 × 5	269	26	288	24168BK30 ;AH 24168H	362	558	4	27.1	HN72
340	Tr385 × 5	167	30	176	23072BK ;AH 3072	382	518	4	21	HNL77
	Tr380 × 5	206	26	226	24072BK30 ;AH 24072H	382	518	4	22.7	HNL76
	Tr400 × 5	229	35	238	23172BK ;AH 3172	382	578	4	33	HN80
	Tr380 × 5	269	26	289	24172BK30 ;AH 24172H	382	578	4	29.6	HN76
360	Tr410 × 5	170	31	180	23076BK ;AH 3076	402	538	4	23.2	HNL82
	Tr400 × 5	208	28	228	24076BK30 ;AH 24076H	402	538	4	23.7	HNL80
	Tr420 × 5	232	36	242	23176BK ;AH 3176	402	598	4	35.7	HN84
	Tr400 × 5	271	28	291	24176BK30 ;AH 24176H	402	598	4	31.3	HN80
380	Tr430 × 5	183	33	193	23080BK ;AH 3080	422	578	4	27.3	HNL86
	Tr420 × 5	228	28	248	24080BK30 ;AH 24080H	422	578	4	27.1	HNL84
	Tr440 × 5	240	38	250	23180BK ;AH 3180	428	622	5	39.5	HN88
	Tr420 × 5	278	28	298	24180BK30 ;AH 24180H	428	622	5	34.4	HN84
400	Tr450 × 5	186	34	196	23084BK ;AH 3084	442	598	4	29	HNL90
	Tr440 × 5	230	30	252	24084BK30 ;AH 24084H	442	598	4	29	HNL88

1) Standard thread shapes and dimensions are as per JIS B0207 (metric thread).

2) Indicates reference dimensions before attachment of withdrawal sleeve.

3) Indicates withdrawal sleeve mass.

4) Indicates number of nut to be used at time of disassembly. See pages C-2 to C-10 for nut dimensions.

Note: 1. Please refer to page B-232, B-235 for bearing dimensions, rated loads, and mass.

2. Withdrawal sleeve numbers appended with the suffix "H" signify high pressure oil (hydraulic) design. (See page B-221)

Withdrawal Sleeves

(For spherical roller bearings)

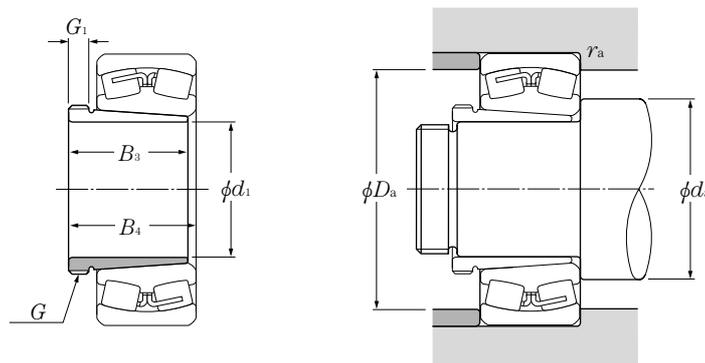

d_1 400 ~ 480mm

d_1	Boundary dimensions				Bearing numbers	Abutment and fillet dimensions			Mass ³⁾ kg (approx.)	Appro- ⁴⁾ pate nut no.
	thread ¹⁾ G	mm B_3	G_1	$B_4^{2)}$		d_a min	mm D_a max	r_{as} max		
400	Tr460 × 5	266	40	276	23184BK ;AH 3184	448	672	5	46.5	HN92
	Tr440 × 5	310	30	332	24184BK30 ;AH 24184H	448	672	5	40.3	HN88
420	Tr470 × 5	194	35	205	23088BK ;AHX 3088	468	622	5	32	HNL94
	Tr460 × 5	242	30	264	24088BK30 ;AH 24088H	468	622	5	31.9	HNL92
	Tr480 × 5	270	42	281	23188BK ;AHX 3188	468	692	5	49.8	HN96
440	Tr460 × 5	310	30	332	24188BK30 ;AH 24188H	468	692	5	42.3	HN92
	Tr490 × 5	202	37	213	23092BK ;AHX 3092	488	652	5	35.2	HNL98
	Tr480 × 5	250	32	273	24092BK30 ;AH 24092H	488	652	5	34.7	HNL96
	Tr510 × 6	285	43	296	23192BK ;AHX 3192	496	724	6	57.9	HN102
	Tr480 × 5	332	32	355	24192BK30 ;AH 24192H	496	724	6	47.6	HN96
460	Tr520 × 6	205	38	217	23096BK ;AHX 3096	508	672	5	39.2	HNL104
	Tr500 × 5	250	32	273	24096BK30 ;AH 24096H	508	672	5	36.6	HNL100
	Tr530 × 6	295	45	307	23196BK ;AHX 3196	516	754	6	63.1	HN106
	Tr500 × 5	340	32	363	24196BK30 ;AH 24196H	516	754	6	52.6	HN100
480	Tr540 × 6	209	40	221	230/500BK ;AHX 30/500	528	692	5	42.5	HNL108
	Tr530 × 6	253	35	276	240/500BK30 ;AH 240/500H	528	692	5	43.9	HNL106
	Tr550 × 6	313	47	325	231/500BK ;AHX 31/500	536	794	6	70.9	HN110
	Tr530 × 6	360	35	383	241/500BK30 ;AH 241/500H	536	794	6	59	HN106

1) Standard thread shapes and dimensions are as per JIS B0207 (metric thread).

2) Indicates reference dimensions before attachment of withdrawal sleeve.

3) Indicates withdrawal sleeve mass.

4) Indicates number of nut to be used at time of disassembly. See pages C-2 to C-10 for nut dimensions.

Note: 1. Please refer to page B-234, B-237 for bearing dimensions, rated loads, and mass.

2. Withdrawal sleeve numbers appended with the suffix "H" signify high pressure oil (hydraulic) design. (See page B-213)

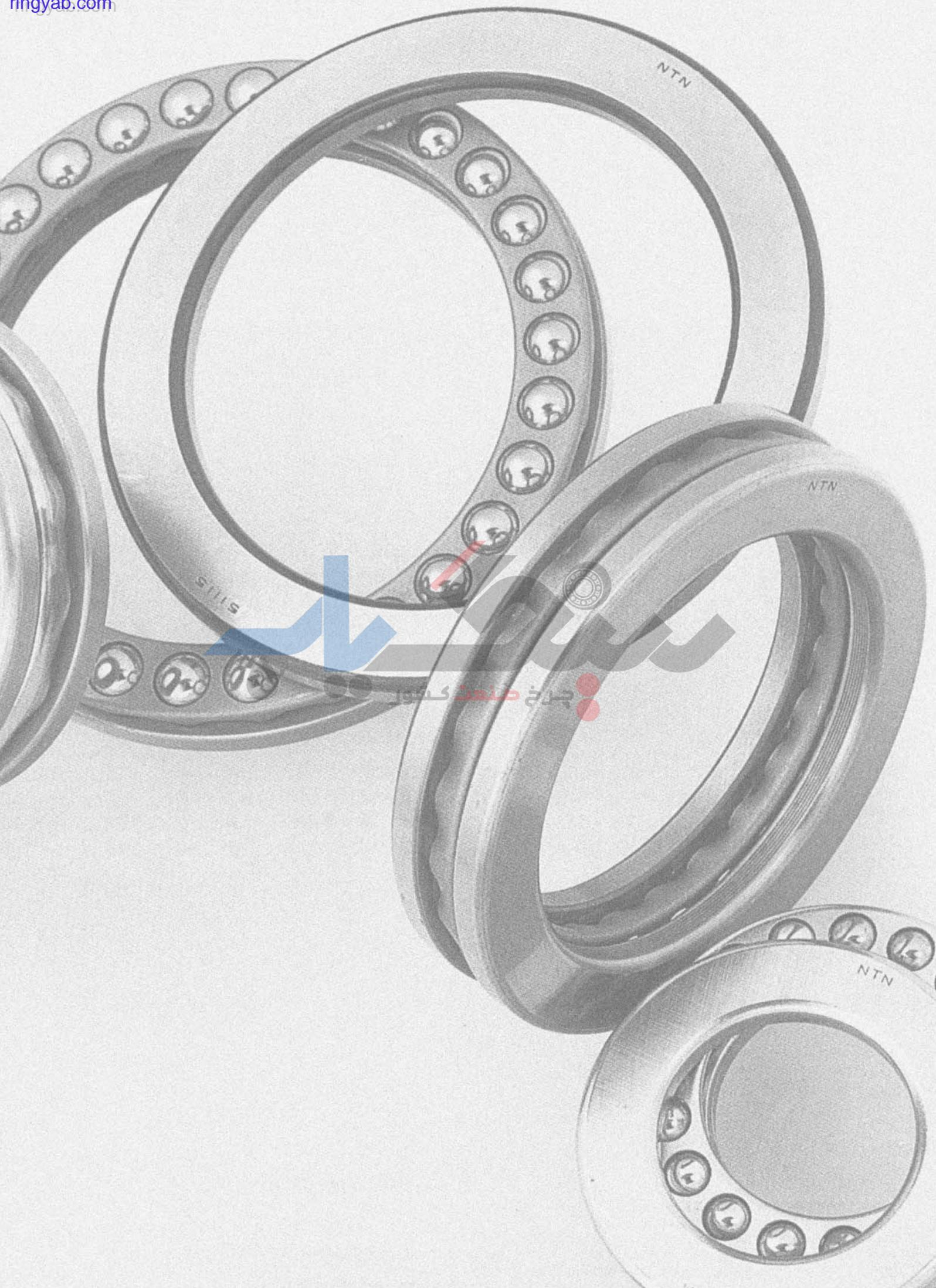

سازمان صنعتی
چرخ صنعت کشور



Single direction thrust ball bearings

Spherical roller thrust bearings

These bearings are designed primarily to support axial loads at contact angles between 30° and 90°. Just as with radial bearings, these bearings differ according to the type of rolling element they use: there are thrust ball bearings that use balls and thrust roller bearings that use rollers.

The configuration and characteristics of each type of bearing are given.

With thrust bearings, it is necessary to supply an axial preload in order to prevent slipping movement between the bearing's rolling elements and raceways. For more detailed information on this point, please refer to the material concerning bearing preload on page A-62.

1. Single direction thrust ball bearings

As shown in **Diagram 1**, the steel balls of single direction thrust ball bearings are arranged between a pair of shaft housing washers (bearing shaft washer and housing shaft washer), and the normal contact angle is 90°. Axial loads can

Table 1 Standard cage types for single direction thrust ball bearings

Bearing series	511	512	513	514
Molded resin cage	51100 ~51107	51200 ~51207	—	—
Pressed cage	51108 ~51152	51208 ~51224	51305 ~51320	51405 ~51415
Machined cage	51156 ~511530	51226 ~51260	51322 ~51340	51416 ~51420

Note: Due to their material properties, molded resin cages can not be used in applications where temperatures exceed 120°C.

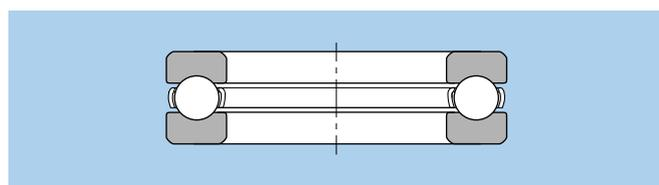

Diagram 1. Single direction thrust ball bearing (with pressed cage)

be supported in only one direction, radial loads can not be accommodated, therefore these bearings are unsuitable for high speed operation.

Table 1 lists the standard cage types for single direction thrust ball bearings.

2. Spherical roller thrust bearings

Just like spherical roller bearings, the center of the spherical surface for spherical roller thrust bearings is the point where the raceway surface of the housing raceway washer meets the center axis of the bearing. Since spherical roller thrust bearings incorporate barrel-shaped rollers as rolling elements, they also have self-aligning properties. (See **Diagram 2**)

Under normal load conditions, the allowable misalignment is 1° to 2°, although this will vary depending upon the bearing's dimension series.

These bearings use machined copper alloy cages and a guide sleeve is attached to the inner ring to guide the cage. The axial load capacity of these bearings is high, and a certain amount of radial load can also be accommodated when the ring is in an axially loaded state. However, it is necessary to operate these bearings where the load condition meet $F_r/F_a \leq 0.55$.

These bearings have some spots where lubricant cannot enter such as the gap between the cage and guide sleeve. It is necessary to use oil lubrication even in low speed operation.

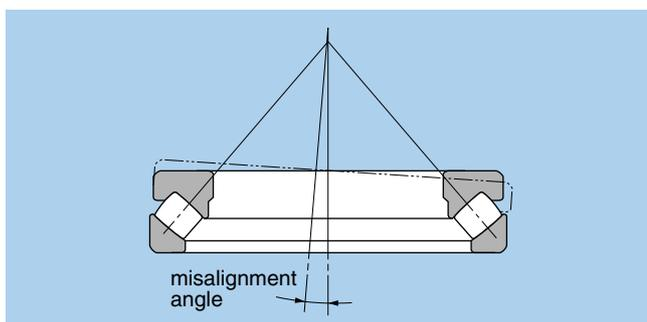

Diagram 2. Spherical roller thrust bearings

3. Cylindrical roller thrust bearings

Thrust bearings incorporating cylindrical rollers are available in single row, double row, triple row, and four row varieties. (See **Diagram 3**) NTN Engineering offers the 811, 812 and 893 series of standard series bearings that conform to dimension series 11, 12 and 93 prescribed in JIS, as well as other special dimensions.

Cylindrical roller thrust bearings are able to receive axial loads only, and have high axial rigidity which makes them well suited for heavy axial loads. Needle roller bearing information for series 811, 812, and 893 is also listed in the dimension tables.

Furthermore, bearings with dimensions not listed in the dimension tables are also manufactured. Contact **NTN Engineering** for more information.

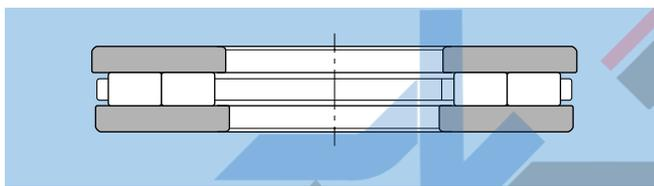

Diagram 3. Double row cylindrical roller thrust bearings

4. Tapered roller thrust bearings

Although not listed in the dimension tables, tapered roller bearings like those in **Diagram 4** are also manufactured. Contact **NTN Engineering** for more detailed information.

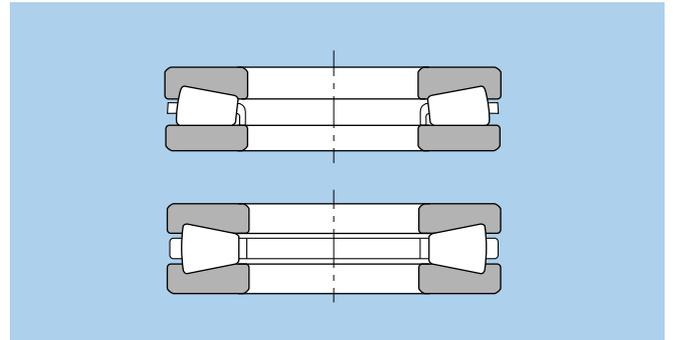
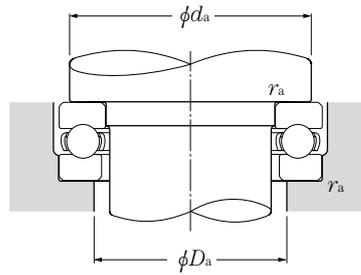
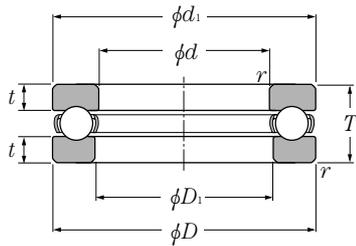

Diagram 4. Tapered roller thrust bearings



Single Direction Thrust Ball Bearings



Equivalent bearing load
dynamic
 $P_a = F_a$
static
 $P_{oa} = F_a$

d 10 ~ 50mm

	Boundary dimensions				Basic load ratings				Limiting speeds		Bearing numbers	Dimensions			Abutment and fillet dimensions			Mass kg (approx.)
	mm				dynamic kN		static kgf		min ⁻¹			mm			mm			
	d	D	T	$r_s \min^{1)}$	C_a	C_{oa}	C_a	C_{oa}	grease	oil		$d_{is \max}^{2)}$	$D_{is \min}^{3)}$	t	$d_a \min$	$D_a \max$	$r_{as} \max$	
10	24	9	0.3	10.0	14.0	1 020	1 420	6 700	9 500	51100 51200	24	11	2.5	18	16	0.3	0.021	
	26	11	0.6	12.7	17.1	1 290	1 740	5 800	8 300		26	12	3.3	20	16	0.6	0.03	
12	26	9	0.3	10.3	15.4	1 050	1 570	6 400	9 200	51101 51201	26	13	2.5	20	18	0.3	0.023	
	28	11	0.6	13.2	19.0	1 340	1 940	5 600	8 000		28	14	3.3	22	18	0.6	0.034	
15	28	9	0.3	10.5	16.8	1 070	1 710	6 200	8 800	51102 51202	28	16	2.5	23	20	0.3	0.024	
	32	12	0.6	16.6	24.8	1 690	2 530	5 000	7 100		32	17	3.5	25	22	0.6	0.046	
17	30	9	0.3	10.8	18.2	1 100	1 850	6 000	8 500	51103 51203	30	18	2.5	25	22	0.3	0.026	
	35	12	0.6	17.2	27.3	1 750	2 780	4 800	6 800		35	19	3.5	28	24	0.6	0.054	
20	35	10	0.3	14.2	24.7	1 450	2 520	5 200	7 500	51104 51204	35	21	2.5	29	26	0.3	0.04	
	40	14	0.6	22.3	37.5	2 270	3 850	4 100	5 900		40	22	4.1	32	28	0.6	0.081	
25	42	11	0.6	19.6	37.0	1 990	3 800	4 600	6 500	51105 51205 51305 51405	42	26	3	35	32	0.6	0.06	
	47	15	0.6	27.8	50.5	2 830	5 150	3 700	5 300		47	27	4.3	38	34	0.6	0.111	
	52	18	1	35.5	61.5	3 650	6 250	3 200	4 600		52	27	5	41	36	1	0.176	
	60	24	1	55.5	89.5	5 650	9 100	2 600	3 700		60	27	6.9	46	39	1	0.33	
30	47	11	0.6	20.4	42.0	2 080	4 300	4 300	6 200	51106 51206 51306 51406	47	32	3	40	37	0.6	0.069	
	52	16	0.6	29.3	58.0	2 990	5 950	3 400	4 900		52	32	5	43	39	0.6	0.139	
	60	21	1	43.0	78.5	4 350	8 000	2 800	3 900		60	32	6.4	48	42	1	0.269	
	70	28	1	72.5	126	7 400	12 800	2 200	3 200		70	32	8.3	54	46	1	0.516	
35	52	12	0.6	20.4	44.5	2 080	4 550	3 900	5 600	51107 51207 51307 51407	52	37	3.5	45	42	0.6	0.085	
	62	18	1	39.0	78.0	4 000	7 950	2 900	4 200		62	37	5.2	51	46	1	0.215	
	68	24	1	55.5	105	5 650	10 700	2 400	3 500		68	37	7.2	55	48	1	0.383	
	80	32	1.1	87.0	155	8 850	15 800	1 900	2 800		80	37	9.6	62	53	1	0.759	
40	60	13	0.6	26.9	63.0	2 740	6 400	3 500	5 000	51108 51208 51308 51408	60	42	3.8	52	48	0.6	0.125	
	68	19	1	47.0	98.5	4 800	10 000	2 700	3 900		68	42	5.5	57	51	1	0.276	
	78	26	1	69.0	135	7 050	13 700	2 200	3 100		78	42	7.6	63	55	1	0.548	
	90	36	1.1	112	205	11 500	20 900	1 700	2 500		90	42	10.7	70	60	1	1.08	
45	65	14	0.6	27.9	69.0	2 840	7 050	3 200	4 600	51109 51209 51309 51409	65	47	4	57	53	0.6	0.148	
	73	20	1	48.0	105	4 850	10 700	2 600	3 700		73	47	6	62	56	1	0.317	
	85	28	1	80.0	163	8 150	16 700	2 000	2 900		85	47	8.3	69	61	1	0.684	
	100	39	1.1	130	242	13 200	24 700	1 600	2 200		100	47	11.6	78	67	1	1.43	
50	70	14	0.6	28.8	75.5	2 930	7 700	3 100	4 500	51110 51210	70	52	4	62	58	0.6	0.161	
	78	22	1	48.5	111	4 950	11 400	2 400	3 400		78	52	7	67	61	1	0.378	

1) Smallest allowable dimension for chamfer dimension r. 2) Maximum allowable dimension for shaft washer outer dimension d_i .
 3) Smallest allowable dimension for housing washer inner dimension D_i .

Single Direction Thrust Ball Bearings

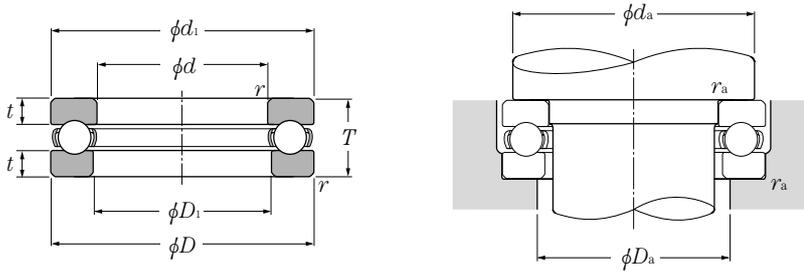

Equivalent bearing load dynamic

$$P_a = F_a$$

static

$$P_{0a} = F_a$$

d 50 ~ 90mm

	Boundary dimensions				Basic load ratings				Limiting speeds		Bearing numbers	Dimensions			Abutment and fillet dimensions			Mass kg (approx.)
	mm				dynamic kN		static kgf		min ⁻¹			mm			mm			
d	D	T	r _{s min} ¹⁾	C _a	C _{0a}	C _a	C _{0a}	grease	oil	d _{1s max} ²⁾	D _{1s min} ³⁾	t	d _{a min}	D _{a max}	r _{as max}			
50	95	31	1.1	96.5	202	9 850	20 600	1 800	2 600	51310	95	52	9.2	77	68	1	0.951	
	110	43	1.5	148	283	15 100	28 800	1 400	2 000		51410A	110	52	12.9	86	74	1.5	1.9
55	78	16	0.6	35.0	93.0	3 550	9 500	2 800	4 000	51111	78	57	5	69	64	0.6	0.226	
	90	25	1	69.5	159	7 100	16 200	2 100	3 000	51211	90	57	7.5	76	69	1	0.608	
	105	35	1.1	119	246	12 200	25 100	1 600	2 300	51311	105	57	10.2	85	75	1	1.29	
	120	48	1.5	178	360	18 200	36 500	1 300	1 800	51411	120	57	14.8	94	81	1.5	2.52	
60	85	17	1	41.5	113	4 200	11 500	2 600	3 700	51112	85	62	5	75	70	1	0.296	
	95	26	1	73.5	179	7 500	18 200	2 000	2 800	51212	95	62	8	81	74	1	0.676	
	110	35	1.1	123	267	12 600	27 200	1 600	2 300	51312	110	62	10.2	90	80	1	1.37	
	130	51	1.5	214	435	21 800	44 500	1 200	1 700	51412	130	62	15.3	102	88	1.5	3.12	
65	90	18	1	41.5	117	4 250	12 000	2 400	3 500	51113	90	67	5.5	80	75	1	0.338	
	100	27	1	75.0	189	7 650	19 200	1 900	2 700	51213	100	67	8.4	86	79	1	0.767	
	115	36	1.1	128	287	13 000	29 300	1 500	2 200	51313	115	67	10.7	95	85	1	1.51	
	140	56	2	232	495	23 600	50 500	1 100	1 600	51413	140	68	17.2	110	95	2	3.96	
70	95	18	1	43.0	127	4 400	12 900	2 400	3 400	51114	95	72	5.5	85	80	1	0.356	
	105	27	1	76.0	199	7 750	20 200	1 800	2 600	51214	105	72	8.4	91	84	1	0.793	
	125	40	1.1	148	340	15 100	34 500	1 400	2 000	51314	125	72	12	103	92	1	2.01	
	150	60	2	250	555	25 500	56 500	1 000	1 500	51414	150	73	18.6	118	102	2	4.86	
75	100	19	1	44.5	136	4 550	13 900	2 200	3 200	51115	100	77	6	90	85	1	0.399	
	110	27	1	77.5	209	7 900	21 300	1 800	2 600	51215	110	77	8.4	96	89	1	0.874	
	135	44	1.5	171	395	17 400	40 500	1 300	1 800	51315	135	77	13.4	111	99	1.5	2.61	
	160	65	2	269	615	27 400	63 000	940	1 400	51415	160	78	20.4	125	110	2	5.97	
80	105	19	1	44.5	141	4 550	14 400	2 200	3 100	51116	105	82	6	95	90	1	0.422	
	115	28	1	78.5	218	8 000	22 300	1 700	2 400	51216	115	82	8.9	101	94	1	0.916	
	140	44	1.5	176	425	18 000	43 000	1 200	1 800	51316	140	82	13.4	116	104	1.5	2.72	
	170	68	2.1	270	620	27 500	63 500	890	1 300	51416	170	83	21.3	133	117	2	7.77	
85	110	19	1	46.0	150	4 700	15 300	2 100	3 000	51117	110	87	6	100	95	1	0.444	
	125	31	1	95.5	264	9 700	26 900	1 600	2 200	51217	125	88	9.8	109	101	1	1.25	
	150	49	1.5	201	490	20 500	50 000	1 100	1 600	51317	150	88	15	124	111	1.5	3.52	
	180	72	2.1	288	685	29 400	70 000	840	1 200	* 51417	177	88	22.7	141	124	2	9.17	
90	120	22	1	59.5	190	6 100	19 400	1 900	2 700	51118	120	92	7	108	102	1	0.687	
	135	35	1.1	117	325	11 900	33 000	1 400	2 000	51218	135	93	11.2	117	108	1	1.7	
	155	50	1.5	198	490	20 200	50 000	1 100	1 600	51318	155	93	15.5	129	116	1.5	3.74	
	190	77	2.1	305	750	31 500	76 500	790	1 100	* 51418	187	93	24.5	149	131	2	11	

1) Smallest allowable dimension for chamfer dimension r. 2) Maximum allowable dimension for shaft washer outer dimension d_{1s}. 3) Smallest allowable dimension for housing washer inner dimension D_{1s}. Note: Bearing numbers marked "*" signify bearings where the bearing shaft washer outer diameter is smaller than the housing shaft washer outer diameter. Therefore when using these bearings, it is possible to use the housing bore as is, without providing a ground undercut on the outer diameter section of the bearing shaft washer as shown in the drawing.

Single Direction Thrust Ball Bearings

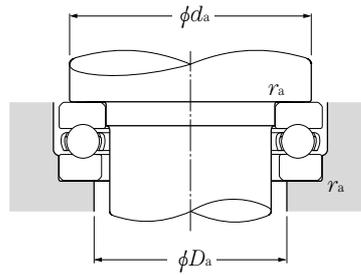
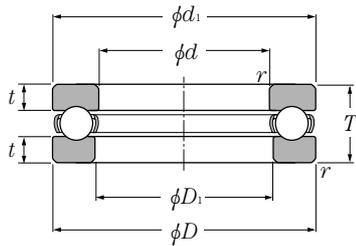

Equivalent bearing load
dynamic
 $P_a = F_a$
static
 $P_{0a} = F_a$

d 100 ~ 200mm

	Boundary dimensions				Basic load ratings				Limiting speeds		Bearing numbers	Dimensions			Abutment and fillet dimensions			Mass kg (approx.)
	d	D	T	$r_s \text{ min}^{1)}$	C_a	C_{0a}	C_a	C_{0a}	grease	oil		$d_{1s \text{ max}}^{2)}$	$D_{1s \text{ min}}^{3)}$	t	$d_a \text{ min}$	$D_a \text{ max}$	$r_{as} \text{ max}$	
100	135	25	1	85.0	268	8 700	27 300	1 700	2 400	51120	135	102	7.5	121	114	1	0.987	
	150	38	1.1	147	410	14 900	42 000	1 300	1 800	51220	150	103	11.7	130	120	1	2.29	
	170	55	1.5	237	595	24 100	60 500	990	1 400	51320	170	103	17.3	142	128	1.5	4.88	
	210	85	3	370	970	37 500	99 000	710	1 000	* 51420	205	103	26.6	165	145	2.5	14.7	
110	145	25	1	87.0	288	8 900	29 400	1 600	2 300	51122	145	112	7.5	131	124	1	1.07	
	160	38	1.1	153	450	15 600	46 000	1 200	1 800	51222	160	113	11.7	140	130	1	2.46	
	190	63	2	267	705	27 300	72 000	870	1 200	* 51322	187	113	20	158	142	2	7.67	
120	155	25	1	89.0	310	9 100	31 500	1 500	2 200	51124	155	122	7.5	141	134	1	1.11	
	170	39	1.1	154	470	15 700	48 000	1 200	1 700	51224	170	123	12.2	150	140	1	2.71	
	210	70	2.1	296	805	30 000	82 500	780	1 100	* 51324	205	123	22.3	173	157	2	10.8	
130	170	30	1	104	350	10 600	36 000	1 300	1 900	51126	170	132	9	154	146	1	1.73	
	190	45	1.5	191	565	19 400	57 500	1 000	1 500	* 51226	187	133	13.9	166	154	1.5	4.22	
	225	75	2.1	330	960	33 500	97 500	720	1 000	* 51326	220	134	24.2	186	169	2	12.7	
140	180	31	1	107	375	10 900	38 500	1 300	1 800	* 51128	178	142	9.5	164	156	1	1.9	
	200	46	1.5	193	595	19 700	60 500	980	1 400	* 51228	197	143	14.4	176	164	1.5	4.77	
	240	80	2.1	350	1 050	35 500	107 000	670	960	* 51328	235	144	26	199	181	2	15.3	
150	190	31	1	109	400	11 100	41 000	1 200	1 800	* 51130	188	152	10	174	166	1	2	
	215	50	1.5	220	685	22 400	70 000	900	1 300	* 51230	212	153	15.8	189	176	1.5	5.87	
	250	80	2.1	360	1 130	37 000	115 000	660	940	* 51330	245	154	26	209	191	2	16.1	
160	200	31	1	112	425	11 400	43 500	1 200	1 700	* 51132	198	162	10	184	176	1	2.1	
	225	51	1.5	223	720	22 800	73 000	870	1 200	* 51232	222	163	16.3	199	186	1.5	6.32	
	270	87	3	450	1 470	45 500	150 000	600	860	* 51332	265	164	27	225	205	2.5	20.7	
170	215	34	1.1	134	510	13 700	52 000	1 100	1 600	* 51134	213	172	10.5	197	188	1	2.77	
	240	55	1.5	261	835	26 600	85 000	810	1 200	* 51234	237	173	17.3	212	198	1.5	7.81	
	280	87	3	465	1 570	47 000	160 000	590	840	* 51334	275	174	27	235	215	2.5	21.6	
180	225	34	1.1	135	525	13 700	54 000	1 100	1 500	* 51136	222	183	10.5	207	198	1	2.92	
	250	56	1.5	266	875	27 100	89 000	780	1 100	* 51236	247	183	17.8	222	208	1.5	8.34	
	300	95	3	490	1 700	50 000	174 000	540	780	* 51336	295	184	29.7	251	229	2.5	27.5	
190	240	37	1.1	170	655	17 400	67 000	980	1 400	* 51138	237	193	11	220	210	1	3.75	
	270	62	2	310	1 060	31 500	108 000	710	1 000	* 51238	267	194	19.6	238	222	2	11.3	
	320	105	4	545	1 950	55 500	199 000	500	710	* 51338	315	195	33.5	266	244	3	35	
200	250	37	1.1	172	675	17 500	69 000	960	1 400	* 51140	247	203	11.5	230	220	1	3.92	

1) Smallest allowable dimension for chamfer dimension r. 2) Maximum allowable dimension for shaft washer outer dimension d_s . 3) Smallest allowable dimension for housing washer inner dimension D_s . Note: Bearing numbers marked " * " signify bearings where the bearing shaft washer outer diameter is smaller than the housing shaft washer outer diameter. Therefore when using these bearings, it is possible to use the housing bore as is, without providing a ground undercut on the outer diameter section of the bearing shaft washer as shown in the drawing.

Single Direction Thrust Ball Bearings

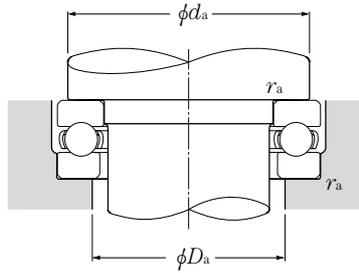
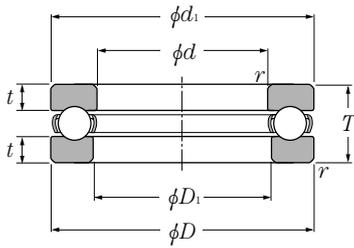

Equivalent bearing load
dynamic

$$P_a = F_a$$

static

$$P_{oa} = F_a$$

d 200 ~ 530mm

	Boundary dimensions				Basic load ratings				Limiting speeds		Bearing numbers	Dimensions			Abutment and fillet dimensions			Mass kg (approx.)
	mm				dynamic kN		static kgf		min ⁻¹			mm			mm			
d	D	T	r _{s min} ¹⁾	C _a	C _{oa}	C _a	C _{oa}	grease	oil		d _{1s max} ²⁾	D _{1s min} ³⁾	t	d _{a min}	D _{a max}	r _{as max}		
200	280	62	2	315	1 110	32 000	113 000	700	990	* 51240	277	204	19.6	248	232	2	11.8	
	340	110	4	595	2 220	61 000	227 000	470	670	* 51340	335	205	34.7	282	258	3	41.8	
220	270	37	1.1	177	740	18 100	75 500	920	1 300	* 51144	267	223	11.5	250	240	1	4.27	
	300	63	2	325	1 210	33 000	123 000	660	950	* 51244	297	224	20.1	268	252	2	13	
240	300	45	1.5	228	935	23 200	95 000	780	1 100	* 51148	297	243	14	276	264	1.5	6.87	
	340	78	2.1	415	1 650	42 500	168 000	550	790	* 51248	335	244	25	299	281	2	22.4	
260	320	45	1.5	232	990	23 600	101 000	750	1 100	* 51152	317	263	14	296	284	1.5	7.38	
	360	79	2.1	440	1 810	45 000	184 000	530	760	* 51252	355	264	24.9	319	301	2	24.2	
280	350	53	1.5	305	1 270	31 000	130 000	650	940	* 51156	347	283	16	322	308	1.5	11.8	
	380	80	2.1	460	1 970	47 000	201 000	510	730	* 51256	375	284	25.4	339	321	2	26.1	
300	380	62	2	355	1 560	36 000	159 000	580	820	* 51160	376	304	19.5	348	332	2	17.2	
	420	95	3	590	2 680	60 000	273 000	440	630	* 51260	415	304	29.7	371	349	2.5	40.6	
320	400	63	2	365	1 660	37 000	169 000	550	790	* 51164	396	324	20	368	352	2	18.4	
340	420	64	2	375	1 760	38 000	179 000	530	760	* 51168	416	344	20.5	388	372	2	19.7	
360	440	65	2	380	1 860	39 000	190 000	510	730	* 51172	436	364	21	408	392	2	21.1	
380	460	65	2	380	1 910	39 000	195 000	500	710	* 51176	456	384	21	428	412	2	22.3	
400	480	65	2	390	2 010	40 000	205 000	480	690	* 51180	476	404	21	448	432	2	23.3	
420	500	65	2	395	2 110	40 500	215 000	470	670	* 51184	495	424	21	468	452	2	24.4	
440	540	80	2.1	515	2 850	52 500	291 000	400	580	* 51188	535	444	26	499	481	2	40	
460	560	80	2.1	525	3 000	53 500	305 000	390	560	* 51192	555	464	26	519	501	2	41.6	
480	580	80	2.1	525	3 100	54 000	315 000	380	550	* 51196	575	484	29.5	539	521	2	43.3	
500	600	80	2.1	575	3 400	58 500	345 000	370	540	511/500	595	504	25	559	541	2	45	
530	640	85	3	645	4 000	66 000	405 000	350	500	511/530	635	534	26	595	575	2.5	55.8	

1) Smallest allowable dimension for chamfer dimension r. 2) Maximum allowable dimension for shaft washer outer dimension d₁. 3) Smallest allowable dimension for housing washer inner dimension D₁. Note: Bearing numbers marked " * " signify bearings where the bearing shaft washer outer diameter is smaller than the housing shaft washer outer diameter. Therefore when using these bearings, it is possible to use the housing bore as is, without providing a ground undercut on the outer diameter section of the bearing shaft washer as shown in the drawing.

Spherical Roller Thrust Bearings

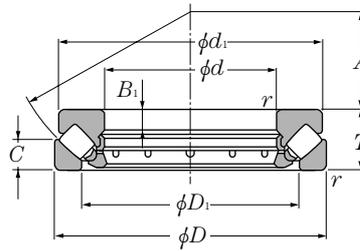

d 60 ~ 160mm

Boundary dimensions				Basic load ratings				Limiting speeds min ⁻¹	Bearing numbers	Dimensions				
mm				dynamic kN	static	dynamic kgf	static			mm				
d	D	T	r _{s min} ¹⁾	C _a	C _{oa}	C _a	C _{oa}	oil	D ₁	d ₁	B ₁	C	A	
60	130	42	1.5	283	805	28 900	82 000	2 600	29412	89	123	15	20	38
65	140	45	2	330	945	33 500	96 500	2 400	29413	96	133	16	21	42
70	150	48	2	365	1 040	37 000	106 000	2 200	29414	103	142	17	23	44
75	160	51	2	415	1 190	42 500	122 000	2 100	29415	109	152	18	24	47
80	170	54	2.1	460	1 380	47 000	141 000	1 900	29416	117	162	19	26	50
85	150	39	1.5	265	820	27 000	84 000	2 300	29317	114	143.5	13	19	50
	180	58	2.1	490	1 480	50 000	151 000	1 800	29417	125	170	21	28	54
90	155	39	1.5	285	915	29 100	93 500	2 300	29318	117	148.5	13	19	52
	190	60	2.1	545	1 680	56 000	172 000	1 700	29418	132	180	22	29	56
100	170	42	1.5	345	1 160	35 500	118 000	2 100	29320	129	163	14	20.8	58
	210	67	3	685	2 130	69 500	217 000	1 500	29420	146	200	24	32	62
110	190	48	2	445	1 500	45 000	152 000	1 800	29322	143	182	16	23	64
	230	73	3	845	2 620	86 500	267 000	1 400	29422	162	220	26	35	69
120	210	54	2.1	535	1 770	54 500	181 000	1 600	29324	159	200	18	26	70
	250	78	4	975	3 050	99 000	310 000	1 300	29424	174	236	29	37	74
130	225	58	2.1	615	2 100	62 500	215 000	1 500	29326	171	215	19	28	76
	270	85	4	1 080	3 550	110 000	360 000	1 200	29426	189	255	31	41	81
140	240	60	2.1	685	2 360	70 000	241 000	1 400	29328	183	230	20	29	82
	280	85	4	1 110	3 750	114 000	385 000	1 200	29428	199	268	31	41	86
150	215	39	1.5	340	1 340	34 500	136 000	1 800	29230	178	208	14	19	82
	250	60	2.1	675	2 390	68 500	243 000	1 400	29330	194	240	20	29	87
	300	90	4	1 280	4 350	131 000	445 000	1 100	29430	214	285	32	44	92
160	225	39	1.5	360	1 460	36 500	149 000	1 700	29232	188	219	14	19	86
	270	67	3	820	2 860	84 000	292 000	1 300	29332	208	260	24	32	92
	320	95	5	1 500	5 150	153 000	525 000	1 000	29432	229	306	34	45	99

1) Smallest allowable dimension for chamfer dimension r.

Spherical Roller Thrust Bearings

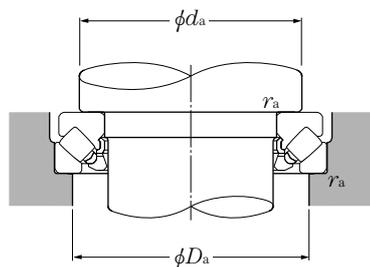

Equivalent bearing load

dynamic

$$P_a = F_a + 1.2F_r$$

static

$$P_{0a} = F_a + 2.7F_r$$

$$\text{when } \frac{F_r}{F_a} \leq 0.55$$

Abutment and fillet dimensions			Mass
d_a	D_a	r_{as}	kg
min	max	max	(approx.)
90	108	1.5	2.78
100	115	2	3.44
105	125	2	4.19
115	132	2	5.07
120	140	2	6.09
115	135	1.5	2.94
130	150	2	7.2
120	140	1.5	3.08
135	157	2	8.38
130	150	1.5	3.94
150	175	2.5	11.5
145	165	2	5.78
165	190	2.5	15
160	180	2	7.92
180	205	3	18.6
170	195	2	9.76
195	225	3	23.7
185	205	2	11.4
205	235	3	25.2
179	196	1.5	4.56
195	215	2	12
220	250	3	30.5
189	206	1.5	4.88
210	235	2.5	15.9
230	265	4	37



Spherical Roller Thrust Bearings

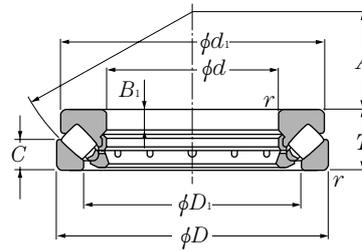

d 170 ~ 320mm

	Boundary dimensions				Basic load ratings				Limiting speeds min ⁻¹	Bearing numbers	Dimensions				
	mm				dynamic kN	static	dynamic kgf	static			mm				
	d	D	T	r _{s min} ¹⁾	C _a	C _{oa}	C _a	C _{oa}	oil		D ₁	d ₁	B ₁	C	A
170	240	42	1.5	425	1 770	43 500	180 000	1 600	29234	198	233	15	20	92	
	280	67	3	855	3 050	87 000	310 000	1 200	29334	216	270	23	32	96	
	340	103	5	1 660	5 750	169 000	590 000	940	29434	243	324	37	50	104	
180	250	42	1.5	450	1 920	45 500	196 000	1 600	29236	208	243	15	20	97	
	300	73	3	995	3 600	102 000	365 000	1 100	29336	232	290	25	35	103	
	360	109	5	1 840	6 200	188 000	635 000	890	29436	255	342	39	52	110	
190	270	48	2	530	2 230	54 000	227 000	1 400	29238	223	262	15	24	104	
	320	78	4	1 150	4 250	117 000	430 000	1 100	29338	246	308	27	38	110	
	380	115	5	2 010	6 800	205 000	695 000	840	29438	271	360	41	55	117	
200	280	48	2	535	2 300	54 500	234 000	1 400	29240	236	271	15	24	108	
	340	85	4	1 280	4 600	131 000	470 000	980	29340	261	325	29	41	116	
	400	122	5	2 230	7 650	228 000	780 000	790	29440	286	380	43	59	122	
220	300	48	2	555	2 480	56 500	253 000	1 300	29244	254	292	15	24	117	
	360	85	4	1 390	5 200	141 000	530 000	940	29344	280	345	29	41	125	
	420	122	6	2 300	8 100	235 000	825 000	760	29444	308	400	43	58	132	
240	340	60	2.1	825	3 600	84 000	365 000	1 100	29248	283	330	19	30	130	
	380	85	4	1 380	5 250	140 000	535 000	910	29348	300	365	29	41	135	
	440	122	6	2 400	8 700	245 000	885 000	740	29448	326	420	43	59	142	
260	360	60	2.1	870	3 950	88 500	400 000	1 100	29252	302	350	19	30	139	
	420	95	5	1 710	6 800	175 000	695 000	810	29352	329	405	32	45	148	
	480	132	6	2 740	10 000	279 000	1 020 000	670	29452	357	460	48	64	154	
280	380	60	2.1	875	4 050	89 000	415 000	1 000	29256	323	370	19	30	150	
	440	95	5	1 800	7 250	184 000	740 000	790	29356	348	423	32	46	158	
	520	145	6	3 350	12 400	340 000	1 270 000	610	29456	387	495	52	68	166	
300	420	73	3	1 190	5 350	121 000	545 000	870	29260	353	405	21	38	162	
	480	109	5	2 140	8 250	218 000	840 000	700	29360	379	460	37	50	168	
	540	145	6	3 450	13 200	350 000	1 340 000	590	29460	402	515	52	70	175	
320	440	73	3	1 260	5 800	128 000	595 000	840	29264	372	430	21	38	172	
	500	109	5	2 220	8 800	226 000	895 000	680	29364	399	482	37	53	180	
	580	155	7.5	3 700	14 200	375 000	1 440 000	550	29464	435	555	55	75	191	

1) Smallest allowable dimension for chamfer dimension r.

Spherical Roller Thrust Bearings

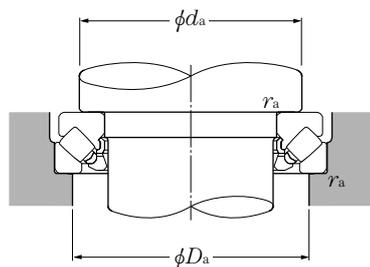

Equivalent bearing load

dynamic

$$P_a = F_a + 1.2F_r$$

static

$$P_{0a} = F_a + 2.7F_r$$

$$\text{when } \frac{F_r}{F_a} \leq 0.55$$

Abutment and fillet dimensions			Mass
d_a	D_a	r_{as}	kg
min	max	max	(approx.)
201	218	1.5	6.02
220	245	2.5	16.6
245	285	4	45
211	228	1.5	6.27
235	260	2.5	21.2
260	300	4	52.9
225	245	2	8.8
250	275	3	26
275	320	4	62
235	255	2	9.14
265	295	3	31.9
290	335	4	73.3
260	275	2	9.94
285	315	3	34.5
310	355	5	77.8
285	305	2	17.5
300	330	3	36.6
330	375	5	82.6
305	325	2	18.6
330	365	4	52
360	405	5	108
325	345	2	19.8
350	390	4	54.6
390	440	5	140
355	380	2.5	30.9
380	420	4	75.8
410	460	5	147
375	400	2.5	33.5
400	440	4	79.9
435	495	6	181



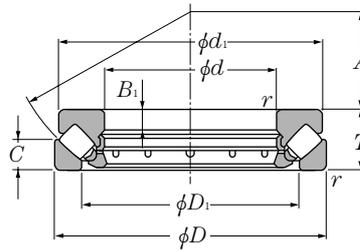

d 340 ~ 500mm

	Boundary dimensions				Basic load ratings				Limiting speeds min ⁻¹	Bearing numbers	Dimensions				
	mm				dynamic kN	static	dynamic kgf	static			mm				
	<i>d</i>	<i>D</i>	<i>T</i>	<i>r</i> _{s min} ¹⁾	<i>C_a</i>	<i>C_{oa}</i>	<i>C_a</i>	<i>C_{oa}</i>	oil		<i>D</i> ₁	<i>d</i> ₁	<i>B</i> ₁	<i>C</i>	<i>A</i>
340	460	73	3		1 240	5 800	126 000	590 000	820	29268	395	445	21	37	183
	540	122	5		2 650	10 700	270 000	1 090 000	610	29368	428	520	41	59	192
	620	170	7.5		4 400	17 500	445 000	1 790 000	500	29468	462	590	61	82	201
360	500	85	4		1 510	7 050	154 000	720 000	720	29272	423	485	25	44	194
	560	122	5		2 710	11 100	276 000	1 130 000	590	29372	448	540	41	59	202
	640	170	7.5		4 500	18 500	460 000	1 890 000	490	29472	480	610	61	82	210
380	520	85	4		1 590	7 650	162 000	780 000	700	29276	441	505	27	42	202
	600	132	6		3 200	13 300	325 000	1 360 000	550	29376	477	580	44	63	216
	670	175	7.5		4 900	19 700	500 000	2 010 000	470	29476	504	640	63	85	230
400	540	85	4		1 620	7 950	165 000	810 000	680	29280	460	526	27	42	212
	620	132	6		3 400	14 500	345 000	1 480 000	530	29380	494	596	44	64	225
	710	185	7.5		5 450	22 100	555 000	2 250 000	440	29480	534	680	67	89	236
420	580	95	5		2 100	10 400	214 000	1 060 000	620	29284	489	564	30	46	225
	650	140	6		3 600	15 500	365 000	1 580 000	500	29384	520	626	48	68	235
	730	185	7.5		5 500	22 800	560 000	2 330 000	430	29484	556	700	67	89	244
440	600	95	5		2 150	10 900	219 000	1 110 000	600	29288	508	585	30	49	235
	680	145	6		3 800	16 400	385 000	1 680 000	480	29388	548	655	49	70	245
	780	206	9.5		6 400	26 200	650 000	2 670 000	390	29488	588	745	74	100	260
460	620	95	5		2 150	11 000	219 000	1 120 000	590	29292	530	605	30	46	245
	710	150	6		4 200	18 500	430 000	1 880 000	460	29392	567	685	51	72	257
	800	206	9.5		6 600	27 900	670 000	2 840 000	380	29492	608	765	74	100	272
480	650	103	5		2 400	12 000	245 000	1 220 000	550	29296	556	635	33	55	259
	730	150	6		4 200	18 700	430 000	1 910 000	450	29396	590	705	51	72	270
	850	224	9.5		7 500	31 500	765 000	3 200 000	350	29496	638	810	81	108	280
500	670	103	5		2 540	13 000	259 000	1 330 000	530	292/500	574	654	33	55	268
	750	150	6		4 300	19 300	435 000	1 970 000	440	293/500	611	725	51	74	280
	870	224	9.5		7 850	33 000	805 000	3 350 000	340	294/500	661	830	81	107	290

1) Smallest allowable dimension for chamfer dimension *r*.

Spherical Roller Thrust Bearings

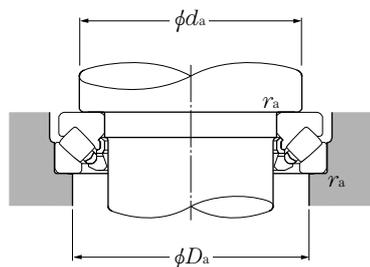

Equivalent bearing load

dynamic

$$P_a = F_a + 1.2F_r$$

static

$$P_{0a} = F_a + 2.7F_r$$

when $\frac{F_r}{F_a} \leq 0.55$

Abutment and fillet dimensions			Mass
mm			kg
d_a min	D_a max	r_{as} max	(approx.)
395	420	2.5	34.4
430	470	4	107
465	530	6	230
420	455	3	50.5
450	495	4	112
485	550	6	240
440	475	3	53.4
480	525	5	143
510	575	6	267
460	490	3	55.8
500	550	5	148
540	610	6	321
490	525	4	76.6
525	575	5	172
560	630	6	333
510	545	4	79.6
550	600	5	195
595	670	8	428
530	570	4	82.8
575	630	5	221
615	690	8	443
555	595	4	98.6
595	650	5	228
645	730	8	552
575	615	4	102
615	670	5	235
670	750	8	569



Locknuts, Lockwashers & Lockplates

Contents

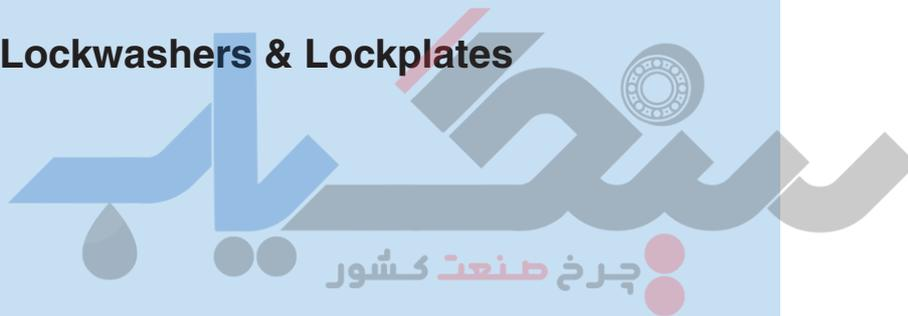

Locknuts	C- 2
Nuts	C- 8
Lockwashers	C-12
Lockplates	C-15
Snap rings for rolling bearings	C-16

Locknuts, Lockwashers & Lockplates



(For adapter sleeve, withdrawal sleeve and shaft)

Series AN

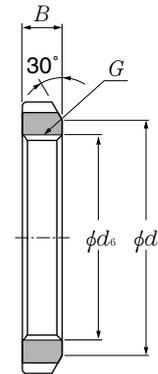
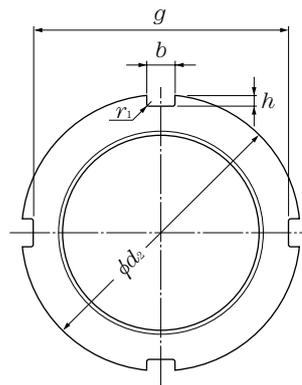

Bearing numbers	thread	Dimensions							Mass kg (approx.)	Reference		
		mm								bore no. ²⁾ of adapter	lock- ³⁾ washer No.	
$G^{1)}$	d_2	d_1	g	b	h	d_6	B	r_1 max				
AN00	M10 × 0.75	18	13.5	14	3	2	10.5	4	0.4	0.005	—	AW00
AN01	M12 × 1	22	17	18	3	2	12.5	4	0.4	0.007	—	AW01
AN02	M15 × 1	25	21	21	4	2	15.5	5	0.4	0.01	—	AW02
AN03	M17 × 1	28	24	24	4	2	17.5	5	0.4	0.013	—	AW03
AN04	M20 × 1	32	26	28	4	2	20.5	6	0.4	0.019	04	AW04
AN05	M25 × 1.5	38	32	34	5	2	25.8	7	0.4	0.025	05	AW05
AN06	M30 × 1.5	45	38	41	5	2	30.8	7	0.4	0.043	06	AW06
AN07	M35 × 1.5	52	44	48	5	2	35.8	8	0.4	0.053	07	AW07
AN08	M40 × 1.5	58	50	53	6	2.5	40.8	9	0.5	0.085	08	AW08
AN09	M45 × 1.5	65	56	60	6	2.5	45.8	10	0.5	0.119	09	AW09
AN10	M50 × 1.5	70	61	65	6	2.5	50.8	11	0.5	0.148	10	AW10
AN11	M55 × 2	75	67	69	7	3	56	11	0.5	0.158	11	AW11
AN12	M60 × 2	80	73	74	7	3	61	11	0.5	0.174	12	AW12
AN13	M65 × 2	85	79	79	7	3	66	12	0.5	0.203	13	AW13
AN14	M70 × 2	92	85	85	8	3.5	71	12	0.5	0.242	14	AW14
AN15	M75 × 2	98	90	91	8	3.5	76	13	0.5	0.287	15	AW15
AN16	M80 × 2	105	95	98	8	3.5	81	15	0.6	0.397	16	AW16
AN17	M85 × 2	110	102	103	8	3.5	86	16	0.6	0.451	17	AW17
AN18	M90 × 2	120	108	112	10	4	91	16	0.6	0.556	18	AW18
AN19	M95 × 2	125	113	117	10	4	96	17	0.6	0.658	19	AW19
AN20	M100 × 2	130	120	122	10	4	101	18	0.6	0.698	20	AW20
AN21	M105 × 2	140	126	130	12	5	106	18	0.7	0.845	21	AW21
AN22	M110 × 2	145	133	135	12	5	111	19	0.7	0.965	22	AW22
AN23	M115 × 2	150	137	140	12	5	116	19	0.7	1.01	—	AW23
AN24	M120 × 2	155	138	145	12	5	121	20	0.7	1.08	24	AW24
AN25	M125 × 2	160	148	150	12	5	126	21	0.7	1.19	—	AW25
AN26	M130 × 2	165	149	155	12	5	131	21	0.7	1.25	26	AW26
AN27	M135 × 2	175	160	163	14	6	136	22	0.7	1.55	—	AW27
AN28	M140 × 2	180	160	168	14	6	141	22	0.7	1.56	28	AW28
AN29	M145 × 2	190	171	178	14	6	146	24	0.7	2	—	AW29
AN30	M150 × 2	195	171	183	14	6	151	24	0.7	2.03	30	AW30
AN31	M155 × 3	200	182	186	16	7	156.5	25	0.7	2.21	—	AW31
AN32	M160 × 3	210	182	196	16	7	161.5	25	0.7	2.59	32	AW32
AN33	M165 × 3	210	193	196	16	7	166.5	26	0.7	2.43	—	AW33
AN34	M170 × 3	220	193	206	16	7	171.5	26	0.7	2.8	34	AW34
AN36	M180 × 3	230	203	214	18	8	181.5	27	0.7	3.07	36	AW36
AN38	M190 × 3	240	214	224	18	8	191.5	28	0.7	3.39	38	AW38
AN40	M200 × 3	250	226	234	18	8	201.5	29	0.7	3.69	40	AW40

1) Standard thread shapes and dimensions are as per JIS B0207 (metric thread).

2) Uses adapter series H31, H2, and H23

3) Can also use washers with straight inner tabs (code "X").

Reference withdrawal sleeve No.								Shaft
AH30	AH240	AH31	AH241	AH2	AH32	AH3	AH23	mm
								(for shaft)
—	—	—	—	—	—	—	—	10
—	—	—	—	—	—	—	—	12
—	—	—	—	—	—	—	—	15
—	—	—	—	—	—	—	—	17
—	—	—	—	—	—	—	—	20
—	—	—	—	—	—	—	—	25
—	—	—	—	—	—	—	—	30
—	—	—	—	—	—	—	—	35
—	—	—	—	—	—	—	—	40
—	—	—	—	AH208	—	AH 308	AH 2308	45
—	—	—	—	AH209	—	AH 309	AH 2309	50
—	—	—	—	AH210	—	AHX310	AHX2310	55
—	—	—	—	AH211	—	AHX311	AHX2311	60
—	—	—	—	AH212	—	AHX312	AHX2312	65
—	—	—	—	—	—	—	—	70
—	—	—	—	AH213	—	AH 313	AH 2313	75
—	—	—	—	AH214	—	AH 314	AHX2314	80
—	—	—	—	AH215	—	AH 315	AHX2315	85
—	—	—	—	AH216	—	AH 316	AHX2316	90
—	—	—	—	AH217	—	AHX317	AHX2317	95
—	—	—	—	AH218	AHX3218	AHX318	AHX2318	100
—	—	—	—	AH219	—	AHX319	AHX2319	105
—	—	—	—	AH220	AHX3220	AHX320	AHX2320	110
—	—	—	AH24122	AH221	—	AHX321	—	115
—	—	AHX3122	—	AH222	—	AHX322	—	120
—	AH24024	—	—	—	AHX3222	—	AHX2322	125
AHX3024	—	AHX3124	AH24124	AH224	—	AHX324	—	130
—	AH24026	—	—	—	AHX3224	—	AHX2324	135
AHX3026	—	AHX3126	AH24126	AH226	—	AHX326	—	140
—	AH24028	—	—	—	AHX3226	—	AHX2326	145
AHX3028	—	AHX3128	AH24128	AH228	—	AHX328	—	150
—	AH24030	—	—	—	AHX3228	—	AHX2328	155
AHX3030	—	—	AH24130	AH230	—	—	—	160
—	—	AHX3130	—	—	AHX3230	AHX330	AHX2330	165
AH 3032	AH24032	—	AH24132	AH232	—	—	—	170
AH 3034	AH24034	AH 3132	AH24134	AH234	AH 3232	AH 332	AH 2332	180
AH 3036	AH24036	AH 3134	AH24136	AH236	AH 3234	AH 334	AH 2334	190
—	AH24038	AH 3136	AH24138	—	AH 3236	—	AH 2336	200

(For adapter sleeve, withdrawal sleeve and shaft)

Series AN

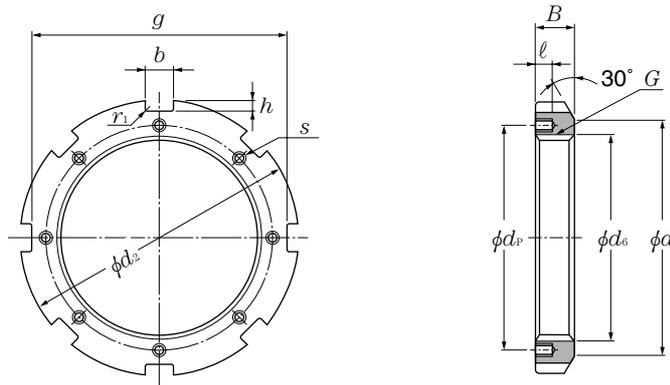

Bearing numbers	Dimensions												Mass kg (approx.)
	thread		mm								thread		
	$G^{1)}$	d_2	d_1	g	b	h	d_6	B	r_1 max	l	$s^{2)}$	d_P	
AN 44	Tr220 × 4	280	250	260	20	10	222	32	0.8	15	M 8 × 1.25	238	5.2
AN 48	Tr240 × 4	300	270	280	20	10	242	34	0.8	15	M 8 × 1.25	258	5.95
AN 52	Tr260 × 4	330	300	306	24	12	262	36	0.8	18	M10 × 1.5	281	8.05
AN 56	Tr280 × 4	350	320	326	24	12	282	38	0.8	18	M10 × 1.5	301	9.05
AN 60	Tr300 × 4	380	340	356	24	12	302	40	0.8	18	M10 × 1.5	326	11.8
AN 64	Tr320 × 5	400	360	376	24	12	322.5	42	0.8	18	M10 × 1.5	345	13.1
AN 68	Tr340 × 5	440	400	410	28	15	342.5	55	1	21	M12 × 1.75	372	23.1
AN 72	Tr360 × 5	460	420	430	28	15	362.5	58	1	21	M12 × 1.75	392	25.1
AN 76	Tr380 × 5	490	450	454	32	18	382.5	60	1	21	M12 × 1.75	414	30.9
AN 80	Tr400 × 5	520	470	484	32	18	402.5	62	1	27	M16 × 2	439	36.9
AN 84	Tr420 × 5	540	490	504	32	18	422.5	70	1	27	M16 × 2	459	43.5
AN 88	Tr440 × 5	560	510	520	36	20	442.5	70	1	27	M16 × 2	477	45.3
AN 92	Tr460 × 5	580	540	540	36	20	462.5	75	1	27	M16 × 2	497	50.4
AN 96	Tr480 × 5	620	560	580	36	20	482.5	75	1	27	M16 × 2	527	62.2
AN100	Tr500 × 5	630	580	584	40	23	502.5	80	1	27	M16 × 2	539	63.3

1) Standard thread shapes and dimensions are as per JIS B0216 (metric trapezoidal screw thread).

2) Thread dimensions are as per JIS B0205 (metric coarse screw thread).

3) Applied to adapter series H31, H32, and H23

bore no. ³⁾ of adapter	Reference lock- plate No.	Shaft
		mm (for shaft)
44	AL 44	220
48	AL 44	240
52	AL 52	260
56	AL 52	280
60	AL 60	300
64	AL 64	320
68	AL 68	340
72	AL 68	360
76	AL 76	380
80	AL 80	400
84	AL 80	420
88	AL 88	440
92	AL 88	460
96	AL 96	480
/500	AL100	500



(For adapter sleeve and shaft)

Series ANL

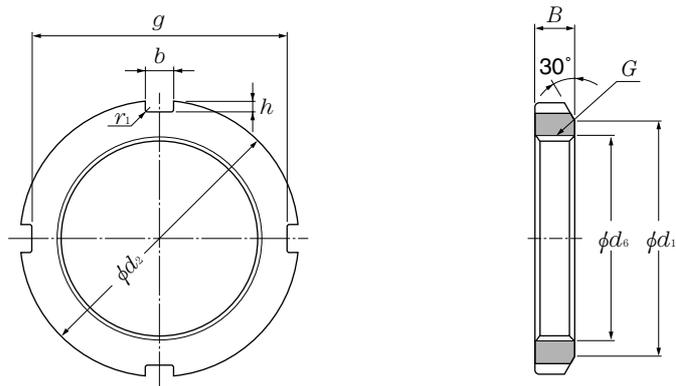

Bearing numbers	thread	Dimensions								Mass kg (approx.)	Reference		shaft mm (for shaft)
		mm									bore no. ⁽²⁾ of adapter	lock- ⁽³⁾ washer no.	
	$G^{(1)}$	d_2	d_1	g	b	h	d_6	B	r_1 max				
ANL24	M120 × 2	145	133	135	12	5	121	20	0.7	0.78	24	AWL24	120
ANL26	M130 × 2	155	143	145	12	5	131	21	0.7	0.88	26	AWL26	130
ANL28	M140 × 2	165	151	153	14	6	141	22	0.7	0.99	28	AWL28	140
ANL30	M150 × 2	180	164	168	14	6	151	24	0.7	1.38	30	AWL30	150
ANL32	M160 × 3	190	174	176	16	7	161.5	25	0.7	1.56	32	AWL32	160
ANL34	M170 × 3	200	184	186	16	7	171.5	26	0.7	1.72	34	AWL34	170
ANL36	M180 × 3	210	192	194	18	8	181.5	27	0.7	1.95	36	AWL36	180
ANL38	M190 × 3	220	202	204	18	8	191.5	28	0.7	2.08	38	AWL38	190
ANL40	M200 × 3	240	218	224	18	8	201.5	29	0.7	2.98	40	AWL40	200

1) Standard thread shapes and dimensions are as per **JIS B0207** (metric fine thread).

2) Applied to adapter series **H30**.

3) Applicable also to washers with straight inner tabs (code "X").

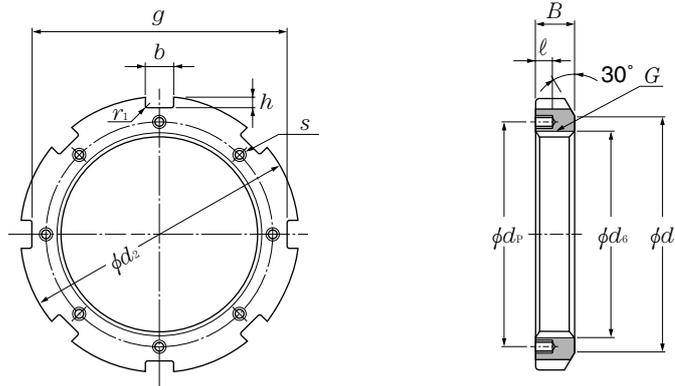

Bearing numbers	Dimensions										thread	Mass kg (approx.)	
	mm												
	$G^{(1)}$	d_2	d_1	g	b	h	d_6	B	r_1 max	l			$s^{(2)}$
ANL 44	Tr220 × 4	260	242	242	20	9	222	30	0.8	12	M 6 × 1	229	3.09
ANL 48	Tr240 × 4	290	270	270	20	10	242	34	0.8	15	M 8 × 1.25	253	5.16
ANL 52	Tr260 × 4	310	290	290	20	10	262	34	0.8	15	M 8 × 1.25	273	5.67
ANL 56	Tr280 × 4	330	310	310	24	10	282	38	0.8	15	M 8 × 1.25	293	6.78
ANL 60	Tr300 × 4	360	336	336	24	12	302	42	0.8	15	M 8 × 1.25	316	9.62
ANL 64	Tr320 × 5	380	356	356	24	12	322.5	42	0.8	15	M 8 × 1.25	335	9.94
ANL 68	Tr340 × 5	400	376	376	24	12	342.5	45	1	15	M 8 × 1.25	355	11.7
ANL 72	Tr360 × 5	420	394	394	28	13	362.5	45	1	15	M 8 × 1.25	374	12
ANL 76	Tr380 × 5	450	422	422	28	14	382.5	48	1	18	M10 × 1.5	398	14.9
ANL 80	Tr400 × 5	470	442	442	28	14	402.5	52	1	18	M10 × 1.5	418	16.9
ANL 84	Tr420 × 5	490	462	462	32	14	422.5	52	1	18	M10 × 1.5	438	17.4
ANL 88	Tr440 × 5	520	490	490	32	15	442.5	60	1	21	M12 × 1.75	462	26.2
ANL 92	Tr460 × 5	540	510	510	32	15	462.5	60	1	21	M12 × 1.75	482	29.6
ANL 96	Tr480 × 5	560	530	530	36	15	482.5	60	1	21	M12 × 1.75	502	28.3
ANL100	Tr500 × 5	580	550	550	36	15	502.5	68	1	21	M12 × 1.75	522	33.6

1) Standard thread shapes and dimensions are as per JIS B0216 (metric trapezoidal screw thread).

2) Thread dimensions are as per JIS B0205 (metric coarse screw thread).

3) Applied to adapter series H30.

bore no. ⁽³⁾ of adapter	Reference lock- plate no.	shaft	Bearing numbers
		mm (for shaft)	

44	ALL44	220	ANL 44
48	ALL48	240	ANL 48
52	ALL48	260	ANL 52
56	ALL56	280	ANL 56
60	ALL60	300	ANL 60
64	ALL64	320	ANL 64
68	ALL64	340	ANL 68
72	ALL72	360	ANL 72
76	ALL76	380	ANL 76
80	ALL76	400	ANL 80
84	ALL84	420	ANL 84
88	ALL88	440	ANL 88
92	ALL88	460	ANL 92
96	ALL96	480	ANL 96
/500	ALL96	500	ANL100

**(For withdrawal and shaft)
Series HN**

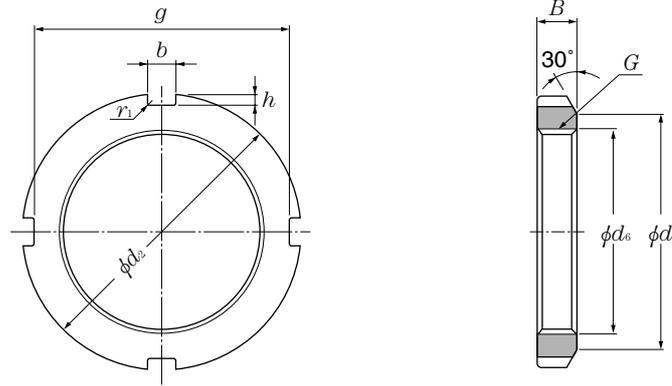

Bearing numbers	thread	Dimensions								Mass	Reference		
		mm									kg	withdrawal sleeve no.	
$G^{1)}$	d_2	d_1	g	b	h	d_6	B	r_1 max	(approx.)	AH240	AH31	AH241	
HN 42	Tr210 × 4	270	238	250	20	10	212	30	0.8	4.75	AH24040	AH 3138	AH24140
HN 44	Tr220 × 4	280	250	260	20	10	222	32	0.8	5.35	—	AH 3140	—
HN 46	Tr230 × 4	290	260	270	20	10	232	34	0.8	5.8	AH24044H	—	AH24144H
HN 48	Tr240 × 4	300	270	280	20	10	242	34	0.8	6.2	—	AH 3144	—
HN 50	Tr250 × 4	320	290	300	20	10	252	36	0.8	7	AH24048H	—	—
HN 52	Tr260 × 4	330	300	306	24	12	262	36	0.8	8.55	—	AH 3148	AH24148H
HN 54	Tr270 × 4	340	310	316	24	12	272	38	0.8	9.2	AH24052H	—	—
HN 56	Tr280 × 4	350	320	326	24	12	282	38	0.8	10	—	—	AH24152H
HN 58	Tr290 × 4	370	330	346	24	12	292	40	0.8	11.8	AH24056H	AH 3152	—
HN 60	Tr300 × 4	380	340	356	24	12	302	40	0.8	12	—	—	AH24156H
HN 62	Tr310 × 5	390	350	366	24	12	312.5	42	0.8	13.4	AH24060H	AH 3156	—
HN 64	Tr320 × 5	400	360	376	24	12	322.5	42	0.8	13.5	—	—	AH24160H
HN 66	Tr330 × 5	420	380	390	28	15	332.5	52	1	20.4	AH24064H	AH 3160	—
HN 68	Tr340 × 5	440	400	410	28	15	342.5	55	1	24.5	—	—	AH24164H
HN 70	Tr350 × 5	450	410	420	28	15	352.5	55	1	25.2	—	AH 3164	—
HN 72	Tr360 × 5	460	420	430	28	15	362.5	58	1	27.5	—	—	AH24168H
HN 74	Tr370 × 5	470	430	440	28	15	372.5	58	1	28.2	—	AH 3168	—
HN 76	Tr380 × 5	490	450	454	32	18	382.5	60	1	33.5	—	—	AH24172H
HN 80	Tr400 × 5	520	470	484	32	18	402.5	62	1	40	—	AH 3172	AH24176H
HN 84	Tr420 × 5	540	490	504	32	18	422.5	70	1	46.9	—	AH 3176	AH24180H
HN 88	Tr440 × 5	560	510	520	36	20	442.5	70	1	48.5	—	AH 3180	AH24184H
HN 92	Tr460 × 5	580	540	540	36	20	462.5	75	1	55	—	AH 3184	AH24188H
HN 96	Tr480 × 5	620	560	580	36	20	482.5	75	1	67	—	AHX3188	AH24192H
HN100	Tr500 × 5	630	590	590	40	23	502.5	80	1	69	—	—	AH24196H
HN102	Tr510 × 6	650	590	604	40	23	513	80	1	75	—	AHX3192	—
HN106	Tr530 × 6	670	610	624	40	23	533	80	1	78	—	AHX3196	AH241/500H
HN110	Tr550 × 6	700	640	654	40	23	553	80	1	92.5	—	AHX31/500	—

1) Standard thread shapes and dimensions are as per JIS B0216 (metric trapezoidal screw thread).

Reference

withdrawal sleeve no.

AH22 AH32 AH23

AH2238	AH 3238	AH2338
AH2240	AH 3240	AH2340
—	—	—
AH2244	—	AH2344
—	—	—
AH2248	—	AH2348
—	—	—
—	—	—
AH2252	—	AH2352
—	—	—
AH2256	—	AH2356
—	—	—
AH2260	AH 3260	—
—	—	—
AH2264	AH 3264	—
—	—	—
—	AH 3268	—
—	—	—
—	AH 3272	—
—	AH 3276	—
—	AH 3280	—
—	AH 3284	—
—	AHX3288	—
—	—	—
—	AHX3292	—
—	AHX3296	—
—	AHX32/500	—



**(For withdrawal and shaft)
Series HNL**

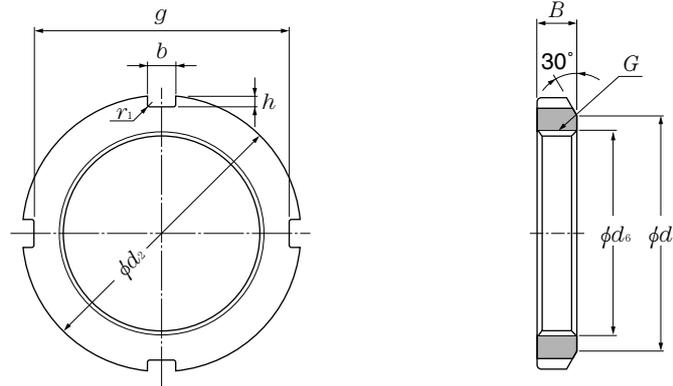

Bearing numbers	thread	Dimensions							r1 max	Mass kg (approx.)	Reference		
		mm									AH30	withdrawal sleeve no. AH24D	AH2
	G ¹⁾	d ₂	d ₁	g	b	h	d ₆	B					
HNL 41	Tr205 × 4	250	232	234	18	8	207	30	0.8	3.43	AH 3038	—	AH238
HNL 43	Tr215 × 4	260	242	242	20	9	217	30	0.8	3.72	AH 3040	—	AH240
HNL 47	Tr235 × 4	280	262	262	20	9	237	34	0.8	4.6	AH 3044	—	AH244
HNL 52	Tr260 × 4	310	290	290	20	10	262	34	0.8	5.8	AH 3048	—	AH248
HNL 56	Tr280 × 4	330	310	310	24	10	282	38	0.8	6.72	AH 3052	—	AH252
HNL 60	Tr300 × 4	360	336	336	24	12	302	42	0.8	9.6	AH 3056	—	AH256
HNL 64	Tr320 × 5	380	356	356	24	12	322.5	42	1	10.3	AH 3060	—	—
HNL 69	Tr345 × 5	410	384	384	28	13	347.5	45	1	11.5	AH 3064	—	—
HNL 72	Tr360 × 5	420	394	394	28	13	362.5	45	1	12.1	—	AH24068H	—
HNL 73	Tr365 × 5	430	404	404	28	13	367.5	48	1	14.2	AH 3068	—	—
HNL 76	Tr380 × 5	450	422	422	28	14	382.5	48	1	16	—	AH24072H	—
HNL 77	Tr385 × 5	450	422	422	28	14	387.5	48	1	15	AH 3072	—	—
HNL 80	Tr400 × 5	470	442	442	28	14	402.5	52	1	18.5	—	AH24076H	—
HNL 82	Tr410 × 5	480	452	452	32	14	412.5	52	1	19	AH 3076	—	—
HNL 84	Tr420 × 5	490	462	462	32	14	422.5	52	1	19.4	—	AH24080H	—
HNL 86	Tr430 × 5	500	472	472	32	14	432.5	52	1	19.8	AH 3080	—	—
HNL 88	Tr440 × 5	520	490	490	32	15	442.5	60	1	27	—	AH24084H	—
HNL 90	Tr450 × 5	520	490	490	32	15	452.5	60	1	23.8	AH 3084	—	—
HNL 92	Tr460 × 5	540	510	510	32	15	462.5	60	1	28	—	AH24088H	—
HNL 94	Tr470 × 5	540	510	510	32	15	472.5	60	1	25	AHX3088	—	—
HNL 96	Tr480 × 5	560	530	530	36	15	482.5	60	1	29.5	—	AH24092H	—
HNL 98	Tr490 × 5	580	550	550	36	15	492.5	60	1	34	AHX3092	—	—
HNL100	Tr500 × 5	580	550	550	36	15	502.5	68	1	35	—	AH24096H	—
HNL104	Tr520 × 6	600	570	570	36	15	523	68	1	37	AHX3096	—	—
HNL106	Tr530 × 6	630	590	590	40	20	533	68	1	47	—	AH240/500H	—
HNL108	Tr540 × 6	630	590	590	40	20	543	68	1	43.5	AHX30/500	—	—

1) Standard thread shapes and dimensions are as per JIS B0216 (metric trapezoidal screw thread).

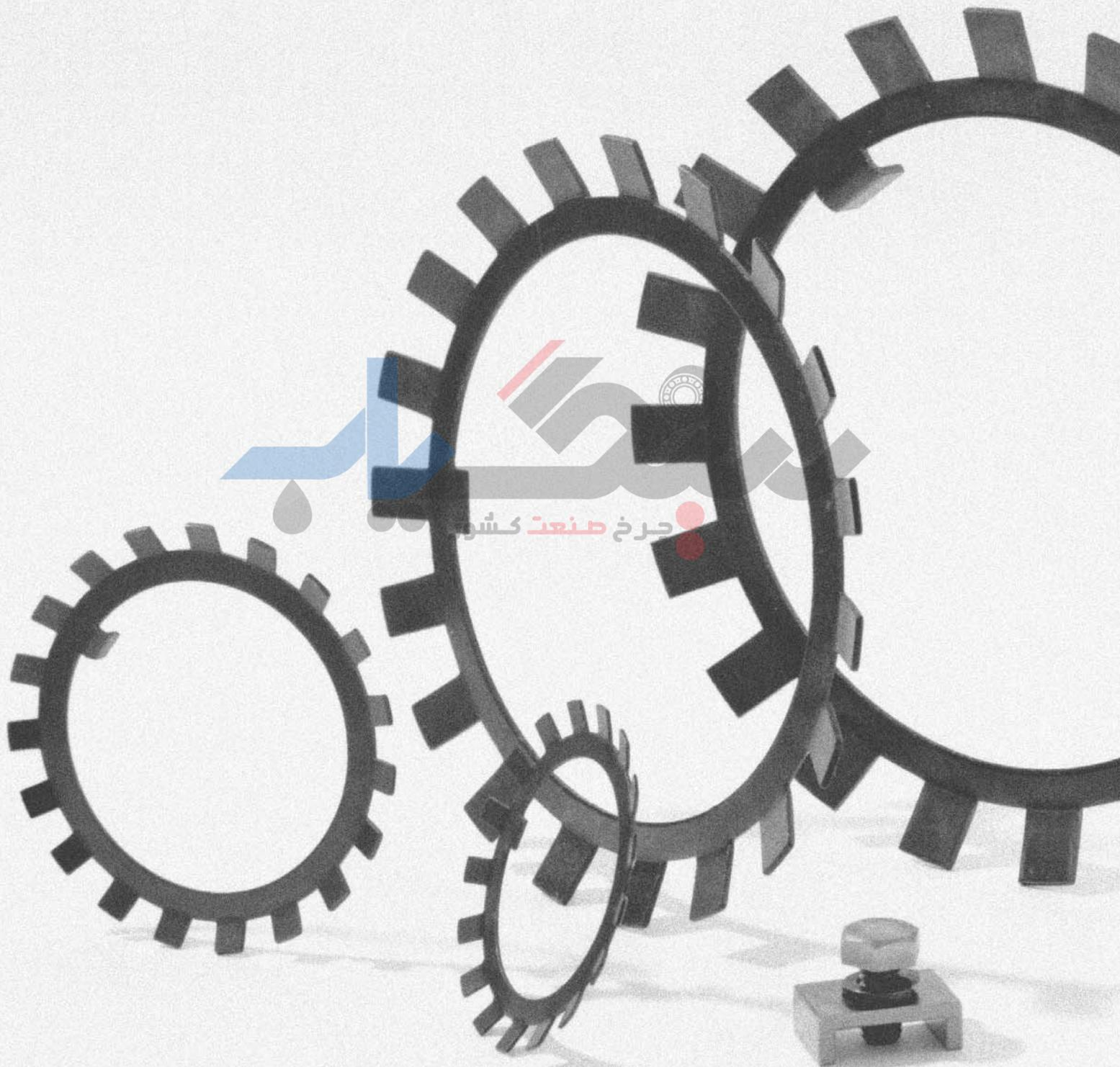

Series AW

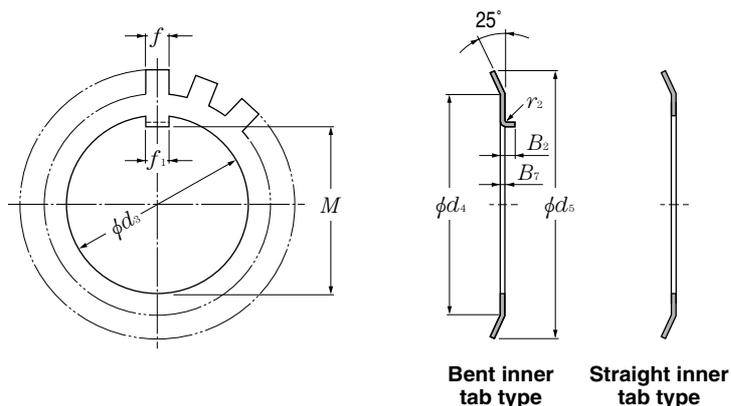

Bearing numbers		Dimensions							No. of tabs		Mass	
bent inner tab type	straight inner tab type	d_3	M	f_1	B_7	f	d_4	d_5	bent inner tab type		kg	
		mm							r_2	B_2	100 pieces (approx.)	
AW00	AW00X	10	8.5	3	1	3	13.5	21	0.5	2	9	0.131
AW01	AW01X	12	10.5	3	1	3	17	25	0.5	2	11	0.192
AW02	AW02X	15	13.5	4	1	4	21	28	1	2.5	13	0.253
AW03	AW03X	17	15.5	4	1	4	24	32	1	2.5	13	0.313
AW04	AW04X	20	18.5	4	1	4	26	36	1	2.5	13	0.35
AW05	AW05X	25	23	5	1.2	5	32	42	1	2.5	13	0.64
AW06	AW06X	30	27.5	5	1.25	5	38	49	1	3.75	13	0.78
AW07	AW07X	35	32.5	6	1.25	5	44	57	1	3.75	15	1.04
AW08	AW08X	40	37.5	6	1.25	6	50	62	1	3.75	15	1.23
AW09	AW09X	45	42.5	6	1.25	6	56	69	1	3.75	17	1.52
AW10	AW10X	50	47.5	6	1.25	6	61	74	1	3.75	17	1.6
AW11	AW11X	55	52.5	8	1.5	7	67	81	1	5.5	17	1.96
AW12	AW12X	60	57.5	8	1.5	7	73	86	1.2	5.5	17	2.53
AW13	AW13X	65	62.5	8	1.5	7	79	92	1.2	5.5	19	2.9
AW14	AW14X	70	66.5	8	1.5	8	85	98	1.2	5.5	19	3.34
AW15	AW15X	75	71.5	8	1.5	8	90	104	1.2	5.5	19	3.56
AW16	AW16X	80	76.5	10	1.8	8	95	112	1.2	5.8	19	4.64
AW17	AW17X	85	81.5	10	1.8	8	102	119	1.2	5.8	19	5.24
AW18	AW18X	90	86.5	10	1.8	10	108	126	1.2	5.8	19	6.23
AW19	AW19X	95	91.5	10	1.8	10	113	133	1.2	5.8	19	6.7
AW20	AW20X	100	96.5	12	1.8	10	120	142	1.2	7.8	19	7.65
AW21	AW21X	105	100.5	12	1.8	12	126	145	1.2	7.8	19	8.26
AW22	AW22X	110	105.5	12	1.8	12	133	154	1.2	7.8	19	9.4
AW23	AW23X	115	110.5	12	2	12	137	159	1.5	7.8	19	10.8
AW24	AW24X	120	115	14	2	12	138	164	1.5	8	19	10.5
AW25	AW25X	125	120	14	2	12	148	170	1.5	8	19	11.8
AW26	AW26X	130	125	14	2	12	149	175	1.5	8	19	11.3
AW27	AW27X	135	130	14	2	14	160	185	1.5	8	19	14.4
AW28	AW28X	140	135	16	2	14	160	192	1.5	10	19	14.2
AW29	AW29X	145	140	16	2	14	171	202	1.5	10	19	16.8
AW30	AW30X	150	145	16	2	14	171	205	1.5	10	19	15.5
AW31	AW31X	155	147.5	16	2.5	16	182	212	1.5	10.5	19	20.9
AW32	AW32X	160	154	18	2.5	16	182	217	1.5	10.5	19	22.2
AW33	AW33X	165	157.5	18	2.5	16	193	222	1.5	10.5	19	24.1
AW34	AW34X	170	164	18	2.5	16	193	232	1.5	10.5	19	24.7
AW36	AW36X	180	174	20	2.5	18	203	242	1.5	10.5	19	26.8
AW38	AW38X	190	184	20	2.5	18	214	252	1.5	10.5	19	27.8
AW40	AW40X	200	194	20	2.5	18	226	262	1.5	10.5	19	29.3

1) Uses adapter series H31, H2, H32, H3, and H23.

bore no. ¹⁾ of adapter	Reference locknut no.	shaft mm (for shaft)
—	AN00	10
—	AN01	12
—	AN02	15
—	AN03	17
04	AN04	20
05	AN05	25
06	AN06	30
07	AN07	35
08	AN08	40
09	AN09	45
10	AN10	50
11	AN11	55
12	AN12	60
13	AN13	65
14	AN14	70
15	AN15	75
16	AN16	80
17	AN17	85
18	AN18	90
19	AN19	95
20	AN20	100
21	AN21	105
22	AN22	110
—	AN23	115
24	AN24	120
—	AN25	125
26	AN26	130
—	AN27	135
28	AN28	140
—	AN29	145
30	AN30	150
—	AN31	155
32	AN32	160
—	AN33	165
34	AN34	170
36	AN36	180
38	AN38	190
40	AN40	200

Allowable washer dimensions

Units mm

Nominal bore dia. d_s mm Over up to/incl	Dimensional tolerance for distance from inner tab to bore surface ΔM		Dimension tolerance for width of inner tab Δr_1	
	High	Low	High	Low
	6 50	+0.3	0	+0.2
50 80	+0.3	0	+0.5	-0.5
80 120	+0.5	0	+0.7	-0.7
120 200	+0.5	0	+1	-1

Above table is applicable to AWL series.

Note: Narrow slit type adapter sleeves appended with the H2, H3, and H23 series code suffix "X", use straight inner tab washers (marked with "X"); wide slit type adapter sleeves without the suffix "X" can either straight or bent inner tab washers.

Series AWL

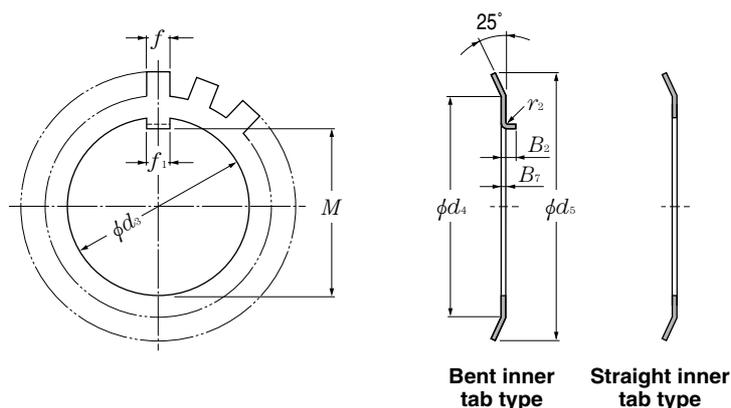

Bearing numbers		Dimensions mm							NO.of tabs Mass			Reference			
bent inner tab type	straight inner tab type	d_3	M	f_1	B_7	f	d_4	d_5	bent inner tab type		kg 100 pieces (approx.)	bore no. ¹⁾ of adapter	locknut no.	shaft mm (for shaft)	
									r_2	B_2					
AWL24	AWL24X	120	115	14	2	12	133	155	1.5	8	19	7.7	24	ANL24	120
AWL26	AWL26X	130	125	14	2	12	143	165	1.5	8	19	8.7	26	ANL26	130
AWL28	AWL28X	140	135	16	2	14	151	175	1.5	10	19	10.9	28	ANL28	140
AWL30	AWL30X	150	145	16	2	14	164	190	1.5	10	19	11.3	30	ANL30	150
AWL32	AWL32X	160	154	18	2.5	16	174	200	1.5	10.5	19	16.2	32	ANL32	160
AWL34	AWL34X	170	164	18	2.5	16	184	210	1.5	10.5	19	19	34	ANL34	170
AWL36	AWL36X	180	174	20	2.5	18	192	220	1.5	10.5	19	18	36	ANL36	180
AWL38	AWL38X	190	184	20	2.5	18	202	230	1.5	10.5	19	20.5	38	ANL38	190
AWL40	AWL40X	200	194	20	2.5	18	218	250	1.5	10.5	19	21.4	40	ANL40	200

1) Uses adapter series H31, H32, and H23.

Note: Wide slit type adapter sleeves without the suffix "X" can use either straight or bent inner tab washers.

Series AL, ALL

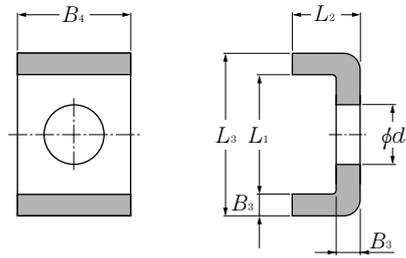

Bearing numbers	Dimensions mm						Mass kg 100 pieces (approx.)	Reference locknut no.
	B_3	B_4	L_2	d_7	L_1	L_3		
AL 44	4	20	12	9	22.5	30.5	2.6	AN44,AN48
AL 52	4	24	12	12	25.5	33.5	3.39	AN52,AN56
AL 60	4	24	12	12	30.5	38.5	3.79	AN60
AL 64	5	24	15	12	31	41	5.35	AN64
AL 68	5	28	15	14	38	48	6.65	AN68,AN72
AL 76	5	32	15	14	40	50	7.96	AN76
AL 80	5	32	15	18	45	55	8.2	AN80,AN84
AL 88	5	36	15	18	43	53	9	AN88,AN92
AL 96	5	36	15	18	53	63	10.4	AN96
AL100	5	40	15	18	45	55	10.5	AN100

Note: Series AL uses series H31,H32,and H23 adapters.

Bearing numbers	Dimensions mm						Mass kg 100 pieces (approx.)	Reference locknut no.
	B_3	B_4	L_2	d_7	L_1	L_3		
ALL44	4	20	12	7	13.5	21.5	2.12	ANL44
ALL48	4	20	12	9	17.5	25.5	2.29	ANL48,ANL52
ALL56	4	24	12	9	17.5	25.5	2.92	ANL56
ALL60	4	24	12	9	20.5	28.5	3.16	ANL60
ALL64	5	24	15	9	21	31	4.56	ANL64,ANL68
ALL72	5	28	15	9	20	30	5.03	ANL72
ALL76	5	28	15	12	24	34	5.28	ANL76,ANL80
ALL84	5	32	15	12	24	34	6.11	ANL84
ALL88	5	32	15	14	28	38	6.45	ANL88,ANL92
ALL96	5	36	15	14	28	38	7.29	ANL96,ANL100

Note: Series ALL uses series H30 adapters.

Snap rings and grooves for rolling bearings

Snap rings for dimension series 18 and 19 bearings

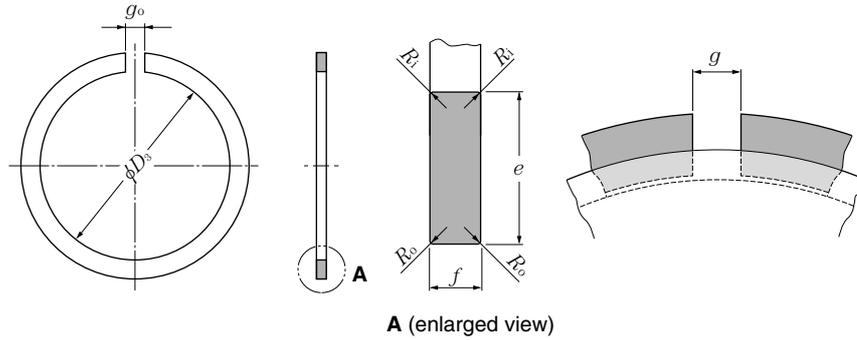

Dimension unit: mm

Bearing No.	Dimensional tolerance of bore		tolerance of ΔD_3						snap ring fitted inside groove		nominal bearing outer diameter D	Reference			applicable bearing dimension series	
	Upper	Lower	max	e		f		g	snap ring outer diameter D_2 max	R_i min		R_o min	thickness variation V_t max	g_0	18	19
				min	max	min	max									
NR1022	20.5	0	-0.3	2.00	1.85	0.7	0.6	2	24.8	22	0.2	0.1	0.06	1	—	10
NR1024	22.5	0	-0.3	2.00	1.85	0.7	0.6	2	26.8	24	0.2	0.1	0.06	1	—	12
NR1028	26.4	0	-0.3	2.05	1.90	0.85	0.75	3	30.8	28	0.25	0.15	0.06	2	—	15
NR1030	28.3	0	-0.3	2.05	1.90	0.85	0.75	3	32.8	30	0.25	0.15	0.06	2	—	17
NR1032	30.3	0	-0.3	2.05	1.90	0.85	0.75	3	34.8	32	0.25	0.15	0.06	2	20	—
NR1034	32.3	0	-0.3	2.05	1.90	0.85	0.75	3	36.8	34	0.25	0.15	0.06	2	22	—
NR1037	35.3	0	-0.3	2.05	1.90	0.85	0.75	3	39.8	37	0.25	0.15	0.06	2	25	20
NR1039	37.3	0	-0.3	2.05	1.90	0.85	0.75	3	41.8	39	0.25	0.15	0.06	2	—	22
NR1040	38.3	0	-0.3	2.05	1.90	0.85	0.75	3	42.8	40	0.25	0.15	0.06	2	28	—
NR1042	40.3	0	-0.4	2.05	1.90	0.85	0.75	3	44.8	42	0.25	0.15	0.06	2	30	25
NR1044	42.3	0	-0.4	2.05	1.90	0.85	0.75	4	46.8	44	0.25	0.15	0.06	2.5	32	—
NR1045	43.3	0	-0.4	2.05	1.90	0.85	0.75	4	47.8	45	0.25	0.15	0.06	2.5	—	28
NR1047	45.3	0	-0.4	2.05	1.90	0.85	0.75	4	49.8	47	0.25	0.15	0.06	2.5	35	30
NR1052	50.3	0	-0.4	2.05	1.90	0.85	0.75	4	54.8	52	0.25	0.15	0.06	2.5	40	32
NR1055	53.3	0	-0.4	2.05	1.90	0.85	0.75	4	57.8	55	0.25	0.15	0.06	2.5	—	35
NR1058	56.3	0	-0.6	2.05	1.90	0.85	0.75	4	60.8	58	0.25	0.15	0.06	2.5	45	—
NR1062	60.2	0	-0.6	2.05	1.90	0.85	0.75	4	64.8	62	0.25	0.15	0.06	2.5	—	40
NR1065	63.2	0	-0.6	2.05	1.90	0.85	0.75	4	67.8	65	0.25	0.15	0.06	2.5	50	—
NR1068	66.2	0	-0.6	2.05	1.90	0.85	0.75	5	70.8	68	0.25	0.15	0.06	3	—	45
NR1072	70.2	0	-0.6	2.05	1.90	0.85	0.75	5	74.8	72	0.25	0.15	0.06	3	55	50
NR1078	75.7	0	-0.6	3.25	3.10	1.12	1.02	5	82.7	78	0.4	0.3	0.06	3	60	—
NR1080	77.4	0	-0.6	3.25	3.10	1.12	1.02	5	84.4	80	0.4	0.3	0.06	3	—	55
NR1085	82.4	0	-0.6	3.25	3.10	1.12	1.02	5	89.4	85	0.4	0.3	0.06	3	65	60
NR1090	87.4	0	-0.6	3.25	3.10	1.12	1.02	5	94.4	90	0.4	0.3	0.06	3	70	65
NR1095	92.4	0	-0.6	3.25	3.10	1.12	1.02	5	99.4	95	0.4	0.3	0.06	3	75	—
NR1100	97.4	0	-0.6	3.25	3.10	1.12	1.02	5	104.4	100	0.4	0.3	0.06	3	80	70
NR1105	101.9	0	-0.8	4.04	3.89	1.12	1.02	5	110.7	105	0.4	0.3	0.06	3	—	75
NR1110	106.9	0	-0.8	4.04	3.89	1.12	1.02	5	115.7	110	0.4	0.3	0.06	3	85	80
NR1115	111.9	0	-0.8	4.04	3.89	1.12	1.02	5	120.7	115	0.4	0.3	0.06	3	90	—
NR1120	116.9	0	-0.8	4.04	3.89	1.12	1.02	7	125.7	120	0.4	0.3	0.06	4	95	85
NR1125	121.8	0	-0.8	4.04	3.89	1.12	1.02	7	130.7	125	0.4	0.3	0.06	4	100	90
NR1130	126.8	0	-0.8	4.04	3.89	1.12	1.02	7	135.7	130	0.4	0.3	0.06	4	105	95
NR1140	136.8	0	-1.0	4.04	3.89	1.7	1.6	7	145.7	140	0.6	0.5	0.06	4	110	100
NR1145	141.8	0	-1.0	4.04	3.89	1.7	1.6	7	150.7	145	0.6	0.5	0.06	4	—	105
NR1150	146.8	0	-1.2	4.04	3.89	1.7	1.6	7	155.7	150	0.6	0.5	0.06	4	120	110
NR1165	161	0	-1.2	4.85	4.70	1.7	1.6	7	171.5	165	0.6	0.5	0.06	4	130	120
NR1175	171	0	-1.2	4.85	4.70	1.7	1.6	10	181.5	175	0.6	0.5	0.06	6	140	—
NR1180	176	0	-1.2	4.85	4.70	1.7	1.6	10	186.5	180	0.6	0.5	0.06	6	—	130
NR1190	186	0	-1.4	4.85	4.70	1.7	1.6	10	196.5	190	0.6	0.5	0.06	6	150	140
NR1200	196	0	-1.4	4.85	4.70	1.7	1.6	10	206.5	200	0.6	0.5	0.06	6	160	—

Groove

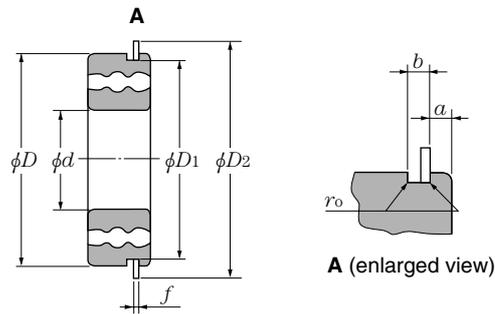

Dimension unit: mm

Nominal bearing outer diameter D	Groove diameter		Dimension series				Groove width		Knuckle radius r_o
	D_1		18		19		b		
	max	min	Groove position a				max	min	
22	20.8	20.5	—	—	1.05	0.90	1.05	0.8	0.2
24	22.8	22.5	—	—	1.05	0.90	1.05	0.8	0.2
28	26.7	26.4	—	—	1.30	1.15	1.20	0.95	0.25
30	28.7	28.4	—	—	1.30	1.15	1.20	0.95	0.25
32	30.7	30.4	1.30	1.15	—	—	1.20	0.95	0.25
34	32.7	32.4	1.30	1.15	—	—	1.20	0.95	0.25
37	35.7	35.4	1.30	1.15	1.70	1.55	1.20	0.95	0.25
39	37.7	37.4	—	—	1.70	1.55	1.20	0.95	0.25
40	38.7	38.4	1.30	1.15	—	—	1.20	0.95	0.25
42	40.7	40.4	1.30	1.15	1.70	1.55	1.20	0.95	0.25
44	42.7	42.4	1.30	1.15	—	—	1.20	0.95	0.25
45	43.7	43.4	—	—	1.70	1.55	1.20	0.95	0.25
47	45.7	45.4	1.30	1.15	1.70	1.55	1.20	0.95	0.25
52	50.7	50.4	1.30	1.15	1.70	1.55	1.20	0.95	0.25
55	53.7	53.4	—	—	1.70	1.55	1.20	0.95	0.25
58	56.7	56.4	1.30	1.15	—	—	1.20	0.95	0.25
62	60.7	60.3	—	—	1.70	1.55	1.20	0.95	0.25
65	63.7	63.3	1.30	1.15	—	—	1.20	0.95	0.25
68	66.7	66.3	—	—	1.70	1.55	1.20	0.95	0.25
72	70.7	70.3	1.70	1.55	1.70	1.55	1.20	0.95	0.25
78	76.2	75.8	1.70	1.55	—	—	1.6	1.3	0.4
80	77.9	77.5	—	—	2.1	1.9	1.6	1.3	0.4
85	82.9	82.5	1.70	1.55	2.1	1.9	1.6	1.3	0.4
90	87.9	87.5	1.70	1.55	2.1	1.9	1.6	1.3	0.4
95	92.9	92.5	1.70	1.55	—	—	1.6	1.3	0.4
100	97.9	97.5	1.70	1.55	2.5	2.3	1.6	1.3	0.4
105	102.6	102.1	—	—	2.5	2.3	1.6	1.3	0.4
110	107.6	107.1	2.1	1.9	2.5	2.3	1.6	1.3	0.4
115	112.6	112.1	2.1	1.9	—	—	1.6	1.3	0.4
120	117.6	117.1	2.1	1.9	3.3	3.1	1.6	1.3	0.4
125	122.6	122.1	2.1	1.9	3.3	3.1	1.6	1.3	0.4
130	127.6	127.1	2.1	1.9	3.3	3.1	1.6	1.3	0.4
140	137.6	137.1	2.5	2.3	3.3	3.1	2.2	1.9	0.6
145	142.6	142.1	—	—	3.3	3.1	2.2	1.9	0.6
150	147.6	147.1	2.5	2.3	3.3	3.1	2.2	1.9	0.6
165	161.8	161.3	3.3	3.1	3.7	3.5	2.2	1.9	0.6
175	171.8	181.3	3.3	3.1	—	—	2.2	1.9	0.6
180	176.8	176.3	—	—	3.7	3.5	2.2	1.9	0.6
190	186.8	186.3	3.3	3.1	3.7	3.5	2.2	1.9	0.6
200	196.8	196.5	3.3	3.1	—	—	2.2	1.9	0.6

Snap rings and grooves for rolling bearings

Snap rings for diameter series 0, 2, 3 and 4 bearings

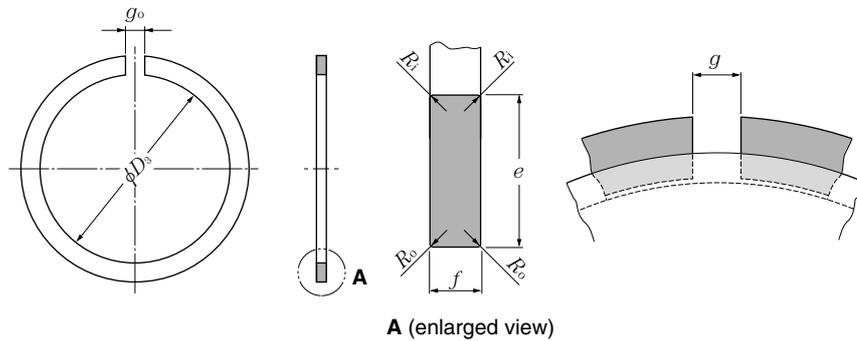

Dimension unit: mm

Bearing No.	Dimensional tolerance of bore								snap ring fitted inside groove snap ring outer diameter D_2 max	nominal bearing outer diameter D	R_i min	R_o min	Reference		applicable bearing dimension series				
	tolerance of ΔD_3			e	min	max	f	min					g	thickness variation V_t max	g_o	0	2	3	4
	Upper	Lower	max																
NR 30	27.9	0	-0.4	3.25	3.10	1.12	1.02	3	34.7	30	0.4	0.3	0.06	2	—	10	9	8	
NR 32	29.9	0	-0.4	3.25	3.10	1.12	1.02	3	36.7	32	0.4	0.3	0.06	2	15	12	—	9	
NR 35	32.9	0	-0.4	3.25	3.10	1.12	1.02	3	39.7	35	0.4	0.3	0.06	2	17	15	10	—	
NR 37	34.5	0	-0.4	3.25	3.10	1.12	1.02	3	41.3	37	0.4	0.3	0.06	2	—	—	12	10	
NR 40	37.8	0	-0.4	3.25	3.10	1.12	1.02	3	44.6	40	0.4	0.3	0.06	2	—	17	—	—	
NR 42	39.5	0	-0.5	3.25	3.10	1.12	1.02	3	46.3	42	0.4	0.3	0.06	2	20	—	15	12	
NR 44	41.5	0	-0.5	3.25	3.10	1.12	1.02	3	48.3	44	0.4	0.3	0.06	2	22	—	—	—	
NR 47	44.3	0	-0.5	4.04	3.89	1.12	1.02	4	52.7	47	0.4	0.3	0.06	2.5	25	20	17	—	
NR 50	47.3	0	-0.5	4.04	3.89	1.12	1.02	4	55.7	50	0.4	0.3	0.06	2.5	—	22	—	—	
NR 52	49.4	0	-0.5	4.04	3.89	1.12	1.02	4	57.9	52	0.4	0.3	0.06	2.5	28	25	20	15	
NR 55	52.3	0	-0.5	4.04	3.89	1.12	1.02	4	60.7	55	0.4	0.3	0.06	2.5	30	—	—	—	
NR 56	53.2	0	-0.6	4.04	3.89	1.12	1.02	4	61.7	56	0.4	0.3	0.06	2.5	—	—	22	—	
NR 58	55.2	0	-0.6	4.04	3.89	1.12	1.02	4	63.7	58	0.4	0.3	0.06	2.5	32	28	—	—	
NR 62	59.0	0	-0.6	4.04	3.89	1.7	1.6	4	67.7	62	0.6	0.5	0.06	2.5	35	30	25	17	
NR 65	62.0	0	-0.6	4.04	3.89	1.7	1.6	4	70.7	65	0.6	0.5	0.06	2.5	—	32	—	—	
NR 68	64.2	0	-0.6	4.85	4.70	1.7	1.6	5	74.6	68	0.6	0.5	0.06	3	40	—	28	—	
NR 72	68.2	0	-0.6	4.85	4.70	1.7	1.6	5	78.6	72	0.6	0.5	0.06	3	—	35	30	20	
NR 75	71.2	0	-0.6	4.85	4.70	1.7	1.6	5	81.6	75	0.6	0.5	0.06	3	45	—	32	—	
NR 80	76.2	0	-0.6	4.85	4.70	1.7	1.6	5	86.6	80	0.6	0.5	0.06	3	50	40	35	25	
NR 85	81.2	0	-0.6	4.85	4.70	1.7	1.6	5	91.6	85	0.6	0.5	0.06	3	—	45	—	—	
NR 90	86.2	0	-0.6	4.85	4.70	2.46	2.36	5	96.5	90	0.6	0.5	0.06	3	55	50	40	30	
NR 95	91.2	0	-0.6	4.85	4.70	2.46	2.36	5	101.6	95	0.6	0.5	0.06	3	60	—	—	—	
NR100	96.2	0	-0.8	4.85	4.70	2.46	2.36	5	106.5	100	0.6	0.5	0.06	3	65	55	45	35	
NR110	106.2	0	-0.8	4.85	4.70	2.46	2.36	5	116.6	110	0.6	0.5	0.06	3	70	60	50	40	
NR115	111.2	0	-0.8	4.85	4.70	2.46	2.36	5	121.6	115	0.6	0.5	0.06	3	75	—	—	—	
NR120	114.6	0	-0.8	7.21	7.06	2.82	2.72	7	129.7	120	0.6	0.5	0.06	4	—	65	55	45	
NR125	119.6	0	-0.8	7.21	7.06	2.82	2.72	7	134.7	125	0.6	0.5	0.06	4	80	70	—	—	
NR130	124.6	0	-0.8	7.21	7.06	2.82	2.72	7	139.7	130	0.6	0.5	0.06	4	85	75	60	50	
NR140	134.6	0	-1.2	7.21	7.06	2.82	2.72	7	149.7	140	0.6	0.5	0.06	4	90	80	65	55	
NR145	139.6	0	-1.2	7.21	7.06	2.82	2.72	7	154.7	145	0.6	0.5	0.06	4	95	—	—	—	
NR150	144.5	0	-1.2	7.21	7.06	2.82	2.72	7	159.7	150	0.6	0.5	0.06	4	100	85	70	60	
NR160	154.5	0	-1.2	7.21	7.06	2.82	2.72	7	169.7	160	0.6	0.5	0.06	4	105	90	75	65	
NR170	162.9	0	-1.2	9.60	9.45	3.1	3.0	10	182.9	170	0.6	0.5	0.06	6	110	95	80	—	
NR180	172.8	0	-1.2	9.60	9.45	3.1	3.0	10	192.9	180	0.6	0.5	0.06	6	120	100	85	70	
NR190	182.8	0	-1.4	9.60	9.45	3.1	3.0	10	202.9	190	0.6	0.5	0.06	6	—	105	90	75	
NR200	192.8	0	-1.4	9.60	9.45	3.1	3.0	10	212.9	200	0.6	0.5	0.06	6	130	110	95	80	

Groove

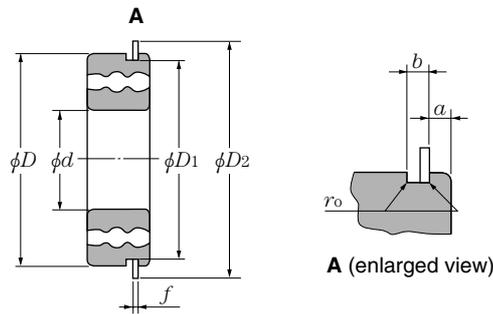

Dimension unit: mm

Nominal bearing outer diameter <i>D</i>	Groove diameter		Dimension series				Groove width		Knuckle radius
	<i>D</i> ₁		0		2, 3, 4		<i>b</i>		<i>r</i> _o
	max	min	Groove position <i>a</i>				max	min	max
30	28.17	27.91	—	—	2.06	1.90	1.65	1.35	0.4
32	30.15	29.90	2.06	1.90	2.06	1.90	1.65	1.35	0.4
35	33.17	32.92	2.06	1.90	2.06	1.90	1.65	1.35	0.4
37	34.77	34.52	—	—	2.06	1.90	1.65	1.35	0.4
40	38.10	37.85	—	—	2.06	1.90	1.65	1.35	0.4
42	39.75	39.50	2.06	1.90	2.06	1.90	1.65	1.35	0.4
44	41.75	41.50	2.06	1.90	—	—	1.65	1.35	0.4
47	44.60	44.35	2.06	1.90	2.46	2.31	1.65	1.35	0.4
50	47.60	47.35	—	—	2.46	2.31	1.65	1.35	0.4
52	49.73	49.48	2.06	1.90	2.46	2.31	1.65	1.35	0.4
55	52.60	52.35	2.08	1.88	—	—	1.65	1.35	0.4
56	53.60	53.35	—	—	2.46	2.31	1.65	1.35	0.4
58	55.60	55.35	2.08	1.88	2.46	2.31	1.65	1.35	0.4
62	59.61	59.11	2.08	1.88	3.28	3.07	2.2	1.9	0.6
65	62.60	62.10	—	—	3.28	3.07	2.2	1.9	0.6
68	64.82	64.31	2.49	2.29	3.28	3.07	2.2	1.9	0.6
72	68.81	68.30	—	—	3.28	3.07	2.2	1.9	0.6
75	71.83	71.32	2.49	2.29	3.28	3.07	2.2	1.9	0.6
80	76.81	76.30	2.49	2.29	3.28	3.07	2.2	1.9	0.6
85	81.81	81.31	—	—	3.28	3.07	2.2	1.9	0.6
90	86.79	86.28	2.87	2.67	3.28	3.07	3.0	2.7	0.6
95	91.82	91.31	2.87	2.67	—	—	3.0	2.7	0.6
100	96.80	96.29	2.87	2.67	3.28	3.07	3.0	2.7	0.6
110	106.81	106.30	2.87	2.67	3.28	3.07	3.0	2.7	0.6
115	111.81	111.30	2.87	2.67	—	—	3.0	2.7	0.6
120	115.21	114.71	—	—	4.06	3.86	3.4	3.1	0.6
125	120.22	119.71	2.87	2.67	4.06	3.86	3.4	3.1	0.6
130	125.22	124.71	2.87	2.67	4.06	3.86	3.4	3.1	0.6
140	135.23	134.72	3.71	3.45	4.90	4.65	3.4	3.1	0.6
145	140.23	139.73	3.71	3.45	—	—	3.4	3.1	0.6
150	145.24	144.73	3.71	3.45	4.90	4.65	3.4	3.1	0.6
160	155.22	154.71	3.71	3.45	4.90	4.65	3.4	3.1	0.6
170	163.65	163.14	3.71	3.45	5.69	5.44	3.8	3.5	0.6
180	173.66	173.15	3.71	3.45	5.69	5.44	3.8	3.5	0.6
190	183.64	183.13	—	—	5.69	5.44	3.8	3.5	0.6
200	193.65	193.14	5.69	5.44	5.69	5.44	3.8	3.5	0.6

Catalog List and Appendix Table Contents

Catalog list.....	D- 2
Appendix table 1: Boundary dimensions of radial bearings (Tapered roller bearings not included)	D- 4
Appendix table 2: Comparison of SI, CGS and gravity units ...	D- 6
Appendix table 3: Conversion to SI unit	D- 7
Appendix table 4: Tenth power multiples of SI unit	D- 7
Appendix table 5: Dimensional tolerance for shafts	D- 8
Appendix table 6: Dimensional tolerance for housing bore	D-10
Appendix table 7: Basic tolerance	D-12
Appendix table 8: Viscosity conversion table	D-13
Appendix table 9: Kgf to N conversion table	D-14
Appendix table 10: US customary to metric conversion table ...	D-15
Appendix table 11: Hardness conversion table (reference)	D-16
Appendix table 12: Greek alphabet list	D-17

Catalog List & Appendix Table



CATALOG TITLES	CATALOG No.
●BALL AND ROLLER BEARINGS	
Ball and Roller Bearings	2202/C/E/I/P/S
Large Bearings	2250/E/P
Precision Rolling Bearings	2260/E/D
Miniature and Extra Small Ball Bearings	3013/E
Ball Bearings Shield and Seal Types	3015/E/S
Care and Maintenance of Bearings	3017/E/S/P
HL Bearings	3020/E
Miniature Molded Rubber Bearings	3014/E
Bearings with Solid Grease	3022/E/S/P
Bearings for Special Environment Ultra Final Series	3023/E
Large Size, Long Operating Life Bearing-EA type	3024/E/P
Long-life AS Series TAB/ETA Bearings	3025/E
Tapered Roller Bearings ECO-Top	3026/E/S/C
Self-Aligning Spherical Roller Bearings LH Series	3027/E/S/C
Bearings for Clean Environment Ultra Final Series	3028/E
Insulated Bearings MEGAOHM™ Series	3030/E/DF
New Standard Series of Spherical Roller Bearing S-TITAN™ Series	3031/JE
Type E Spherical Roller Bearings	3701/E
Sealed Self-Aligning Roller Bearings-WA Type	3702/E/S
FA Tapered Roller Bearings	3802/E/D/C
HUB BEARINGS	4601/E/C
The New Generation of NTN Bearings for wind Turbine	8404/JE
Railway Bearings	8501/E/C
Bearings for Mining Application	8601/E
Spherical Roller Bearings-UA Type	3710/E
Aerospace Bearings	8102/E
●NEEDLE ROLLER BEARINGS	
Needle Roller Bearings	2300/E/I/P/S
Cam Followers & Roller Followers	3604/JE
HK-F Type Drawn Cup Needle Roller Bearings	3029/JE
Miniature Cam Followers	3601/E
●CONSTANT VELOCITY JOINTS	
Constant Velocity Joints for Automobiles	5601/JE
TRI-Ball Joint / Constant Velocity Joints	5602/E
Constant Velocity Joints for Industrial Machines	5603/E

CATALOG TITLES	CATALOG No.
● BEARING UNITS	
Bearing Units	2400/E/I/S
Bearing Units Steel Series	3902/E
Bearing Units Stainless Series	3903/E
Bearing Units Plastic Housing Series	3904/E
Triple-Sealed Bearings for Bearing Units	3905/E
● PLUMMER BLOCKS	
Plummer Blocks	2500E/S
● PARTS FEEDER	
Parts Feeder	7018/E
Parts Feeder Guide Book	7019/E
NTN Parts Feeder with Standard Attachments (for Bolts or Washer)	7016/E
● CLUTCHES	
One-way Clutches (Overrunning Clutches)	6402/E
● PLAIN BEARINGS	
"BEAREE" NTN Engineering Plastics	5100/E
Miniature Plastic Sliding Screws	5112/E
NTN "BEARPHITE" Oil Impregnated Sintered Bearings	5202/CE
Spherical Plain Bearings	5301/E
● HANDBOOK	
Bearing Units Handbook	9011/E/S
Rolling Bearings Handbook	9012/E
Needle Roller Bearings Handbook	9013/E
● GUIDE BOOK	
New Products Guide	9208/E/C
Automotive Products Guide Book	8021/E/D/F/C
Food Machinery Component Guide	9209/E
Product Catalog for Paper Manufacturing Machinery	9210/E
Steel Manufacturing Machinery Product Guide Book	9211/E
● ELECTRONIC CATALOG	
NTN Electronic Catalog (CD-ROM for Windows)	7903/E
NTN Autoparts Catalog (CD-ROM for Windows)	7905/E
Reference Kit Program -Bearing Interchange- (CD-ROM for Windows)	7907/E
● OTHERS	
Bearing Handling	9103/E/P/S

C:Chinese E:English F:French D:Germany I:Italian
 K:Korean S:Spanish P:Portugal J: Japanese

Note : The above are basic numbers. Renewal of the suffix by a revision.

Appendix table 2: Comparison of SI, CGS and gravity units-1

Unit system	Quantity	Length L	Mass M	Time T	Acceleration	Force	Stress	Pressure	Energy
SI		m	kg	s	m/s^2	N	Pa	Pa	J
CGS system		cm	g	s	Gal	dyn	dyn/cm ²	dyn/cm ²	erg
Gravitation system		m	kgf · s ² /m	s	m/s^2	kgf	kgf/m ²	kgf/m ²	kgf · m

Appendix table 3: SI-customary unit conversion table-1

Quantity	Unit designation	Symbol	Conversion rate to SI	SI unit designation	Symbol
Angle	Degree	°	$\pi/180$	Radian	rad
	Minute	'	$\pi/10\ 800$		
	Second	" (sec)	$\pi/648\ 000$		
Length	Meter	m	1	Meter	m
	Micron	μ	10^{-6}		
	Angstrom	Å	10^{-10}		
Area	Square meter	m ²	1	Square meter	m ²
	Are	a	10^2		
	Hectare	ha	10^4		
Volume	Cubic meter	m ³	1	Cubic meter	m ³
	Liter	R.L	10^{-3}		
Mass	Kilogram	kg	1	Kilogram	kg
	Ton	t	10^3		
	Kilogram force / square second per meter	kgf · s ² /m	9.806 65		
Time	Second	s	1	Second	s
	Minute	min	60		
	Hour	h	3 600		
	Day	d	86 400		
Speed	Meters per second	m/s	1	Meters per second	m/s
	Knot	kn	1 852/3 600		
Frequency and vibration	Cycle	s ⁻¹ (pps)	1	Hertz	Hz
Revolutions (rotational speed)	Revolutions per minute (rpm)	rpm (r/min)	1/60	Per second	s ⁻¹
Angular speed	Radians per second	rad/s	1	Radians per second	rad/s
Acceleration	Meters per square second	m/s ²	1	Meters per second square	m/s ²
	G	G	9.806 65		
Force	Kilogram force	kgf	9.806 65	Newton	N
	Ton force	tf	9 806.65		
	Dyne	dyn	10^{-5}		
Force moment	Kilogram force / meter	kgf · m	9.806 65	Newton meter	N · m
Inertia moment	Kilogram force / meter / square second	kgf · m · s ²	9.806 65	Kilogram / square meter	kg · m ²
Stress	Kilogram force per square meter	kgf/m ²	9.806 65	Pascal or newton per square meter	Pa or N/m ²
Pressure	Kilogram force per square meter	kgf/m ²	9.806 65	Pascal	Pa
	Meter water column	mH ₂ O	9 806.65		
	Meter of mercury	mHg	101 325/0.76		
	Torr	Torr	101 325/760		
	Atmosphere	atm	101 325		
	Bar	bar	10^5		
Energy	Erg	erg	10^{-7}	Joule	J
	IT calorie	cal _{IT}	4.186 8		
	Kilogram force / meter	kgf · m	9.806 65		
	Kilowatt hour	kW · h	3.600×10^6		
	Metric horsepower per hour	PS · h	$2.647\ 79 \times 10^6$		
Power rate and power	Watt	W	1	Watt	W
	Metric horsepower	PS	735.5		
	Kilogram force / meter per second	kgf · m/s	9.806 65		

Appendix table 2: Comparison of SI, CGS and gravity units-2

Unit system \ Quantity	Power rate	Temperature	Viscosity	Dynamic viscosity	Magnetic flux	Flux density	Magnetic field strength
SI	W	K	Pa · s	m ² /s	Wb	T	A/m
CGS system	erg/s	°C	P	St	Mx	Gs	Oe
Gravitation system	kgf · m/s	°C	kgf · s/m ²	m ² /s	—	—	—

Appendix table 3: SI-customary unit conversion table-2

Quantity	Unit designation	Symbol	Conversion rate to SI	SI unit designation	Symbol
Viscosity	Poise	P	10 ⁻¹	Pascal second	Pa · s
	Centipoise	cP	10 ⁻³		
	Kilogram force / square second per meter	kgf · s/m ²	9.806 65		
Dynamic viscosity	Stoke	St	10 ⁻⁴	Square meter per second	m ² /s
	Centistoke	cSt	10 ⁻⁶		
Temperature	Degree	°C	+273.15	Kelvin	K
Radioactive Dosage	Curie	Ci	3.7 × 10 ¹⁰	Becquerel	Bq
	Roentgen	R	2.58 × 10 ⁻⁴	Coulombs per kilogram	C/kg
Absorption dosage	Rad	rad	10 ⁻²	Gray	Gy
Dosage equivalent	Rem	rem	10 ⁻²	Sievert	Sv
Magnetic flux	Maxwell	Mx	10 ⁻⁸	Weber	Wb
Flux density	Gamma	γ	10 ⁻⁹	Tesla	T
	Gauss	Gs	10 ⁻⁴		
Magnetic field strength	Oersted	Oe	10 ³ /4 π	Amperes per meter	A/m
Quantity of electricity	Coulomb	C	1	Coulomb	C
Potential difference	Volt	V	1	Volt	V
Electric resistance	Ohm	Ω	1	Ohm	Ω
Current	Ampere	A	1	Ampere	A

Appendix table 4: Tenth power multiples of SI unit

Multiples of unit	Prefix		Multiples of unit	Prefix	
	Name	Symbol		Name	Symbol
10 ¹⁸	Exa	E	10 ⁻¹	Deci	d
10 ¹⁵	Peta	P	10 ⁻²	Centi	c
10 ¹²	Tera	T	10 ⁻³	Mili	m
10 ⁹	Giga	G	10 ⁻⁶	Micro	μ
10 ⁶	Mega	M	10 ⁻⁹	Nano	n
10 ³	Kilo	k	10 ⁻¹²	Pico	p
10 ²	Hecto	h	10 ⁻¹⁵	Femto	f
10	Deca	da	10 ⁻¹⁸	Ato	a

Appendix table 5: Dimensional tolerance for shafts

Diameter division mm		a13		c12		d6		e6		e13		f5		f6		g5		g6	
over	incl.	high	low	high	low	high	low	high	low	high	low	high	low	high	low	high	low	high	low
3	6	-270	-450	-70	-190	-30	-38	-20	-28	-20	-200	-10	-15	-10	-18	-4	-9	-4	-12
6	10	-280	-500	-80	-230	-40	-49	-25	-34	-25	-245	-13	-19	-13	-22	-5	-11	-5	-14
10	18	-290	-560	-95	-275	-50	-61	-32	-43	-32	-302	-16	-24	-16	-27	-6	-14	-6	-17
18	30	-300	-630	-110	-320	-65	-78	-40	-53	-40	-370	-20	-29	-20	-33	-7	-16	-7	-20
30	40	-310	-700	-120	-370	-80	-96	-50	-66	-50	-440	-25	-36	-25	-41	-9	-20	-9	-25
40	50	-320	-710	-130	-380														
50	65	-340	-800	-140	-440	-100	-119	-60	-79	-60	-520	-30	-43	-30	-49	-10	-23	-10	-29
65	80	-360	-820	-150	-450														
80	100	-380	-920	-170	-520	-120	-142	-72	-94	-72	-612	-36	-51	-36	-58	-12	-27	-12	-34
100	120	-410	-950	-180	-530														
120	140	-460	-1 090	-200	-600	-145	-170	-85	-110	-85	-715	-43	-61	-43	-68	-14	-32	-14	-39
140	160	-520	-1 150	-210	-610														
160	180	-580	-1 210	-230	-630														
180	200	-660	-1 380	-240	-700	-170	-199	-100	-129	-100	-820	-50	-70	-50	-79	-15	-35	-15	-44
200	225	-740	-1 460	-260	-720														
225	250	-820	-1 540	-280	-740														
250	280	-920	-1 730	-300	-820	-190	-222	-110	-142	-110	-920	-56	-79	-56	-88	-17	-40	-17	-49
280	315	-1 050	-1 860	-330	-850														
315	355	-1 200	-2 090	-360	-930	-210	-246	-125	-161	-125	-1 015	-62	-87	-62	-98	-18	-43	-18	-54
355	400	-1 350	-2 240	-400	-970														
400	450	-1 500	-2 470	-440	-1 070	-230	-270	-135	-175	-135	-1 105	-68	-95	-68	-108	-20	-47	-20	-60
450	500	-1 650	-2 620	-480	-1 110														
500	560	-	-	-	-	-260	-304	-145	-189	-	-	-	-	-76	-120	-	-	-22	-66
560	630	-	-	-	-														
630	710	-	-	-	-	-290	-340	-160	-210	-	-	-	-	-80	-130	-	-	-24	-74
710	800	-	-	-	-														
800	900	-	-	-	-	-320	-376	-170	-226	-	-	-	-	-86	-142	-	-	-26	-82
900	1 000	-	-	-	-														
1 000	1 120	-	-	-	-	-350	-416	-195	-261	-	-	-	-	-98	-164	-	-	-28	-94
1 120	1 250	-	-	-	-														
1 250	1 400	-	-	-	-	-390	-468	-220	-298	-	-	-	-	-110	-188	-	-	-30	-108
1 400	1 600	-	-	-	-														

Diameter division mm		j5		js5		j6		js6		j7		k4		k5		k6		m5	
over	incl.	high	low	high	low	high	low	high	low	high	low	high	low	high	low	high	low	high	low
3	6	+3	-2	+2.5	-2.5	+6	-2	+4	-4	+8	-4	+5	+1	+6	+1	+9	+1	+9	+4
6	10	+4	-2	+3	-3	+7	-2	+4.5	-4.5	+10	-5	+5	+1	+7	+1	+10	+1	+12	+6
10	18	+5	-3	+4	-4	+8	-3	+5.5	-5.5	+12	-6	+6	+1	+9	+1	+12	+1	+15	+7
18	30	+5	-4	+4.5	-4.5	+9	-4	+6.5	-6.5	+13	-8	+8	+2	+11	+2	+15	+2	+17	+8
30	40																		
40	50	+6	-5	+5.5	-5.5	+11	-5	+8	-8	+15	-10	+9	+2	+13	+2	+18	+2	+20	+9
50	65																		
65	80	+6	-7	+6.5	-6.5	+12	-7	+9.5	-9.5	+18	-12	+10	+2	+15	+2	+21	+2	+24	+11
80	100																		
100	120	+6	-9	+7.5	-7.5	+13	-9	+11	-11	+20	-15	+13	+3	+18	+3	+25	+3	+28	+13
120	140																		
140	160	+7	-11	+9	-9	+14	-11	+12.5	-12.5	+22	-18	+15	+3	+21	+3	+28	+3	+33	+15
160	180																		
180	200																		
200	225	+7	-13	+10	-10	+16	-13	+14.5	-14.5	+25	-21	+18	+4	+24	+4	+33	+4	+37	+17
225	250																		
250	280	+7	-16	+11.5	-11.5	+16	-16	+16	-16	+26	-26	+20	+4	+27	+4	+36	+4	+43	+20
280	315																		
315	355	+7	-18	+12.5	-12.5	+18	-18	+18	-18	+29	-28	+22	+4	+29	+4	+40	+4	+46	+21
355	400																		
400	450	+7	-20	+13.5	-13.5	+20	-20	+20	-20	+31	-32	+25	+5	+32	+5	+45	+5	+50	+23
450	500																		
500	560	-	-	-	-	-	-	+22	-22	-	-	-	-	-	-	+44	0	-	-
560	630																		
630	710	-	-	-	-	-	-	+25	-25	-	-	-	-	-	-	+50	0	-	-
710	800																		
800	900	-	-	-	-	-	-	+28	-28	-	-	-	-	-	-	+56	0	-	-
900	1 000																		
1 000	1 120	-	-	-	-	-	-	+33	-33	-	-	-	-	-	-	+66	0	-	-
1 120	1 250																		
1 250	1 400	-	-	-	-	-	-	+39	-39	-	-	-	-	-	-	+78	0	-	-
1 400	1 600																		

Unit μm

h4		h5		h6		h7		h8		h9		h10		h11		h13		js4		Diameter division mm	
high	low	high	low	high	low	high	low	high	low	high	low	high	low	high	low	high	low	high	low	over	incl.
0	-4	0	-5	0	-8	0	-12	0	-18	0	-30	0	-48	0	-75	0	-180	+2	-2	3	6
0	-4	0	-6	0	-9	0	-15	0	-22	0	-36	0	-58	0	-90	0	-220	+2	-2	6	10
0	-5	0	-8	0	-11	0	-18	0	-27	0	-43	0	-70	0	-110	0	-270	+2.5	-2.5	10	18
0	-6	0	-9	0	-13	0	-21	0	-33	0	-52	0	-84	0	-130	0	-330	+3	-3	18	30
0	-7	0	-11	0	-16	0	-25	0	-39	0	-62	0	-100	0	-160	0	-390	+3.5	-3.5	30	40
																				40	50
0	-8	0	-13	0	-19	0	-30	0	-46	0	-74	0	-120	0	-190	0	-460	+4	-4	50	65
																				65	80
0	-10	0	-15	0	-22	0	-35	0	-54	0	-87	0	-140	0	-220	0	-540	+5	-5	80	100
																				100	120
0	-12	0	-18	0	-25	0	-40	0	-63	0	-100	0	-160	0	-250	0	-630	+6	-6	120	140
																				140	160
																				160	180
0	-14	0	-20	0	-29	0	-46	0	-72	0	-115	0	-185	0	-290	0	-720	+7	-7	180	200
																				200	225
																				225	250
0	-16	0	-23	0	-32	0	-52	0	-81	0	-130	0	-210	0	-320	0	-810	+8	-8	250	280
																				280	315
0	-18	0	-25	0	-36	0	-57	0	-89	0	-140	0	-230	0	-360	0	-890	+9	-9	315	355
																				355	400
0	-20	0	-27	0	-40	0	-63	0	-97	0	-155	0	-250	0	-400	0	-970	+10	-10	400	450
																				450	500
-	-	-	-	0	-44	0	-70	0	-110	0	-175	0	-280	0	-440	0	-	-	-	500	560
																				560	630
-	-	-	-	0	-50	0	-80	0	-125	0	-200	0	-320	0	-500	0	-	-	-	630	710
																				710	800
-	-	-	-	0	-56	0	-90	0	-140	0	-230	0	-360	0	-560	0	-	-	-	800	900
																				900	1 000
-	-	-	-	0	-66	0	-105	0	-165	0	-260	0	-420	0	-660	0	-	-	-	1 000	1 120
																				1 120	1 250
-	-	-	-	0	-78	0	-125	0	-195	0	-310	0	-500	0	-780	0	-	-	-	1 250	1 400
																				1 400	1 600

Unit μm

m6		n5		n6		p5		p6		r6		r7		Basic tolerance				Diameter division mm	
high	low	high	low	high	low	high	low	high	low	high	low	high	low	IT2	IT3	IT5	IT7	over	incl.
+12	+4	+13	+8	+16	+8	+17	+12	+20	+12	+23	+15	+27	+15	1.5	2.5	5	12	3	6
+15	+6	+16	+10	+19	+10	+21	+15	+24	+15	+28	+19	+34	+19	1.5	2.5	6	15	6	10
+18	+7	+20	+12	+23	+12	+26	+18	+29	+18	+34	+23	+41	+23	2	3	8	18	10	18
+21	+8	+24	+15	+28	+15	+31	+22	+35	+22	+41	+28	+49	+28	2.5	4	9	21	18	30
+25	+9	+28	+17	+33	+17	+37	+26	+42	+26	+50	+34	+59	+34	2.5	4	11	25	30	40
																		40	50
+30	+11	+33	+20	+39	+20	+45	+32	+51	+32	+60	+41	+71	+41	3	5	13	30	50	65
																		65	80
+35	+13	+38	+23	+45	+23	+52	+37	+59	+37	+73	+51	+86	+51	4	6	15	35	80	100
																		100	120
+40	+15	+45	+27	+52	+27	+61	+43	+68	+43	+88	+63	+103	+63	5	8	18	40	120	140
																		140	160
																		160	180
+46	+17	+51	+31	+60	+31	+70	+50	+79	+50	+106	+77	+123	+77	7	10	20	46	180	200
																		200	225
																		225	250
+52	+20	+57	+34	+66	+34	+79	+56	+88	+56	+126	+94	+146	+94	8	12	23	52	250	280
																		280	315
+57	+21	+62	+37	+73	+37	+87	+62	+98	+62	+144	+108	+165	+108	9	13	25	57	315	355
																		355	400
+63	+23	+67	+40	+80	+40	+95	+68	+108	+68	+166	+126	+189	+126	10	15	27	63	400	450
																		450	500
+70	+26	-	-	+88	+44	-	-	+122	+78	+194	+150	+220	+150	-	-	-	70	500	560
																		560	630
+80	+30	-	-	+100	+50	-	-	+138	+88	+225	+175	+255	+175	-	-	-	80	630	710
																		710	800
+90	+34	-	-	+112	+56	-	-	+156	+100	+266	+210	+300	+210	-	-	-	90	800	900
																		900	1 000
+106	+40	-	-	+132	+66	-	-	+186	+120	+316	+250	+355	+250	-	-	-	105	1 000	1 120
																		1 120	1 250
+126	+48	-	-	+156	+78	-	-	+218	+140	+378	+300	+425	+300	-	-	-	125	1 250	1 400
																		1 400	1 600

Appendix table 6: Dimensional tolerance for housing bore

Diameter division mm over incl.	E7		E10		E11		E12		F6		F7		F8		G6		G7		H6	
	high	low	high	low	high	low	high	low	high	low	high	low	high	low	high	low	high	low	high	low
3 6	+32	+20	+68	+20	+95	+20	+140	+20	+18	+10	+22	+10	+28	+10	+12	+4	+16	+4	+8	0
6 10	+40	+25	+83	+25	+115	+25	+175	+25	+22	+13	+28	+13	+35	+13	+14	+5	+20	+5	+9	0
10 18	+50	+32	+102	+32	+142	+32	+212	+32	+27	+16	+34	+16	+43	+16	+17	+6	+24	+6	+11	0
18 30	+61	+40	+124	+40	+170	+40	+250	+40	+33	+20	+41	+20	+53	+20	+20	+7	+28	+7	+13	0
30 40	+75	+50	+150	+50	+210	+50	+300	+50	+41	+25	+50	+25	+64	+25	+25	+9	+34	+9	+16	0
40 50	+90	+60	+180	+60	+250	+60	+360	+60	+49	+30	+60	+30	+76	+30	+29	+10	+40	+10	+19	0
50 65	+90	+60	+180	+60	+250	+60	+360	+60	+49	+30	+60	+30	+76	+30	+29	+10	+40	+10	+19	0
65 80	+90	+60	+180	+60	+250	+60	+360	+60	+49	+30	+60	+30	+76	+30	+29	+10	+40	+10	+19	0
80 100	+107	+72	+212	+72	+292	+72	+422	+72	+58	+36	+71	+36	+90	+36	+34	+12	+47	+12	+22	0
100 120	+107	+72	+212	+72	+292	+72	+422	+72	+58	+36	+71	+36	+90	+36	+34	+12	+47	+12	+22	0
120 140	+125	+85	+245	+85	+335	+85	+485	+85	+68	+43	+83	+43	+106	+43	+39	+14	+54	+14	+25	0
140 160	+125	+85	+245	+85	+335	+85	+485	+85	+68	+43	+83	+43	+106	+43	+39	+14	+54	+14	+25	0
160 180	+125	+85	+245	+85	+335	+85	+485	+85	+68	+43	+83	+43	+106	+43	+39	+14	+54	+14	+25	0
180 200	+146	+100	+285	+100	+390	+100	+560	+100	+79	+50	+96	+50	+122	+50	+44	+15	+61	+15	+29	0
200 225	+146	+100	+285	+100	+390	+100	+560	+100	+79	+50	+96	+50	+122	+50	+44	+15	+61	+15	+29	0
225 250	+146	+100	+285	+100	+390	+100	+560	+100	+79	+50	+96	+50	+122	+50	+44	+15	+61	+15	+29	0
250 280	+162	+110	+320	+110	+430	+110	+630	+110	+88	+56	+108	+56	+137	+56	+49	+17	+69	+17	+32	0
280 315	+162	+110	+320	+110	+430	+110	+630	+110	+88	+56	+108	+56	+137	+56	+49	+17	+69	+17	+32	0
315 355	+182	+125	+355	+125	+485	+125	+695	+125	+98	+62	+119	+62	+151	+62	+54	+18	+75	+18	+36	0
355 400	+182	+125	+355	+125	+485	+125	+695	+125	+98	+62	+119	+62	+151	+62	+54	+18	+75	+18	+36	0
400 450	+198	+135	+385	+135	+535	+135	+765	+135	+108	+68	+131	+68	+165	+68	+60	+20	+83	+20	+40	0
450 500	+198	+135	+385	+135	+535	+135	+765	+135	+108	+68	+131	+68	+165	+68	+60	+20	+83	+20	+40	0
500 560	+215	+145	-	-	-	-	-	-	+120	+76	+146	+76	+186	+76	+66	+22	+92	+22	+44	0
560 630	+215	+145	-	-	-	-	-	-	+120	+76	+146	+76	+186	+76	+66	+22	+92	+22	+44	0
630 710	+240	+160	-	-	-	-	-	-	+130	+80	+160	+80	+205	+80	+74	+24	+104	+24	+50	0
710 800	+240	+160	-	-	-	-	-	-	+130	+80	+160	+80	+205	+80	+74	+24	+104	+24	+50	0
800 900	+260	+170	-	-	-	-	-	-	+142	+86	+176	+86	+226	+86	+82	+26	+116	+26	+56	0
900 1000	+260	+170	-	-	-	-	-	-	+142	+86	+176	+86	+226	+86	+82	+26	+116	+26	+56	0
1 000 1 120	+300	+195	-	-	-	-	-	-	+164	+98	+203	+98	+263	+98	+94	+28	+133	+28	+66	0
1 120 1 250	+300	+195	-	-	-	-	-	-	+164	+98	+203	+98	+263	+98	+94	+28	+133	+28	+66	0
1 250 1 400	+345	+220	-	-	-	-	-	-	+188	+110	+235	+110	+305	+110	+108	+30	+155	+30	+78	0
1 400 1 600	+345	+220	-	-	-	-	-	-	+188	+110	+235	+110	+305	+110	+108	+30	+155	+30	+78	0
1 600 1 800	+390	+240	-	-	-	-	-	-	+212	+120	+270	+120	+350	+120	+124	+32	+182	+32	+92	0
1 800 2 000	+390	+240	-	-	-	-	-	-	+212	+120	+270	+120	+350	+120	+124	+32	+182	+32	+92	0

Unit μm

Diameter division mm over incl.	K6		K7		M6		M7		N6		N7		P6		P7		R6		R7	
	high	low	high	low	high	low	high	low	high	low	high	low	high	low	high	low	high	low	high	low
3 6	+2	-6	+3	-9	-1	-9	0	-12	-5	-13	-4	-16	-9	-17	-8	-20	-12	-20	-11	-23
6 10	+2	-7	+5	-10	-3	-12	0	-15	-7	-16	-4	-19	-12	-21	-9	-24	-16	-25	-13	-28
10 18	+2	-9	+6	-12	-4	-15	0	-18	-9	-20	-5	-23	-15	-26	-11	-29	-20	-31	-16	-34
18 30	+2	-11	+6	-15	-4	-17	0	-21	-11	-24	-7	-28	-18	-31	-14	-35	-24	-37	-20	-41
30 40	+3	-13	+7	-18	-4	-20	0	-25	-12	-28	-8	-33	-21	-37	-17	-42	-29	-42	-25	-50
40 50	+3	-13	+7	-18	-4	-20	0	-25	-12	-28	-8	-33	-21	-37	-17	-42	-29	-42	-25	-50
50 65	+4	-15	+9	-21	-5	-24	0	-30	-14	-33	-9	-39	-26	-45	-21	-51	-35	-54	-30	-60
65 80	+4	-15	+9	-21	-5	-24	0	-30	-14	-33	-9	-39	-26	-45	-21	-51	-37	-56	-32	-62
80 100	+4	-18	+10	-25	-6	-28	0	-35	-16	-38	-10	-45	-30	-52	-24	-59	-44	-66	-38	-73
100 120	+4	-18	+10	-25	-6	-28	0	-35	-16	-38	-10	-45	-30	-52	-24	-59	-47	-69	-41	-76
120 140	+4	-21	+12	-28	-8	-33	0	-40	-20	-45	-12	-52	-36	-61	-28	-68	-56	-81	-48	-88
140 160	+4	-21	+12	-28	-8	-33	0	-40	-20	-45	-12	-52	-36	-61	-28	-68	-58	-83	-50	-90
160 180	+4	-21	+12	-28	-8	-33	0	-40	-20	-45	-12	-52	-36	-61	-28	-68	-61	-86	-53	-93
180 200	+5	-24	+13	-33	-8	-37	0	-46	-22	-51	-14	-60	-41	-70	-33	-79	-68	-97	-60	-106
200 225	+5	-24	+13	-33	-8	-37	0	-46	-22	-51	-14	-60	-41	-70	-33	-79	-71	-100	-63	-109
225 250	+5	-24	+13	-33	-8	-37	0	-46	-22	-51	-14	-60	-41	-70	-33	-79	-75	-104	-67	-113
250 280	+5	-27	+16	-36	-9	-41	0	-52	-25	-57	-14	-66	-47	-79	-36	-88	-85	-117	-74	-126
280 315	+5	-27	+16	-36	-9	-41	0	-52	-25	-57	-14	-66	-47	-79	-36	-88	-89	-121	-78	-130
315 355	+7	-29	+17	-40	-10	-46	0	-57	-26	-62	-16	-73	-51	-87	-41	-98	-97	-133	-87	-144
355 400	+7	-29	+17	-40	-10	-46	0	-57	-26	-62	-16	-73	-51	-87	-41	-98	-103	-139	-93	-150
400 450	+8	-32	+18	-45	-10	-50	0	-63	-27	-67	-17	-80	-55	-95	-45	-108	-113	-153	-103	-166
450 500	+8	-32	+18	-45	-10	-50	0	-63	-27	-67	-17	-80	-55	-95	-45	-108	-119	-159	-109	-172
500 560	0	-44	0	-70	-26	-70	-26	-96	-44	-88	-44	-114	-78	-122	-78	-148	-150	-194	-150	-220
560 630	0	-44	0	-70	-26	-70	-26	-96	-44	-88	-44	-114	-78	-122	-78	-148	-155	-199	-155	-225
630 710	0	-50	0	-80	-30	-80	-30	-110	-50	-100	-50	-130	-88	-138	-88	-168	-175	-225	-175	-225
710 800	0	-50	0	-80	-30	-80	-30	-110	-50	-100	-50	-130	-88	-138	-88	-168	-185	-235	-185	-265
800 900	0	-56	0	-90	-34	-90	-34	-124	-56	-112	-56	-146	-100	-156	-100	-190	-210	-266	-210	-300
900 1 000	0	-56	0	-90	-34	-90	-34	-124	-56	-112	-56	-146	-100	-156	-100	-190	-220	-276	-220	-310
1 000 1 120	0	-66	0	-105	-40	-106	-40	-145	-66	-132	-66	-171	-120	-186	-120	-225	-250	-316	-250	-355
1 120 1 250	0	-66	0	-105	-40	-106	-40	-145	-66	-132	-66	-171	-120	-186	-120	-225	-260			

Unit μm

H7	H8	H9	H10	H11	H13	J6	Js6		J7	Js7		K5	Diameter division mm	
							high	low		high	low		high	low
+ 12 0	+ 18 0	+ 30 0	+ 48 0	+ 75 0	+180 0	+ 5 -3	+ 4 - 4	+ 6 - 6	+ 6 - 6	+ 6 - 6	0 - 5	3	6	
+ 15 0	+ 22 0	+ 36 0	+ 58 0	+ 90 0	+220 0	+ 5 -4	+ 4.5 - 4.5	+ 8 - 7	+ 7.5 - 7.5	+ 1 - 5	+1 - 5	6	10	
+ 18 0	+ 27 0	+ 43 0	+ 70 0	+110 0	+270 0	+ 6 -5	+ 5.5 - 5.5	+10 - 8	+ 9 - 9	+2 - 6	+2 - 6	10	18	
+ 21 0	+ 33 0	+ 52 0	+ 84 0	+130 0	+330 0	+ 8 -5	+ 6.5 - 6.5	+12 - 9	+10.5 -10.5	+1 - 8	+1 - 8	18	30	
+ 25 0	+ 39 0	+ 62 0	+100 0	+160 0	+390 0	+10 -6	+ 8 - 8	+14 -11	+12.5 -12.5	+2 - 9	+2 - 9	30	40	
												40	50	
+ 30 0	+ 46 0	+ 74 0	+120 0	+190 0	+460 0	+13 -6	+ 9.5 - 9.5	+18 -12	+15 -15	+3 -10	+3 -10	50	65	
												65	80	
+ 35 0	+ 54 0	+ 87 0	+140 0	+220 0	+540 0	+16 -6	+11 -11	+22 -13	+17.5 -17.5	+2 -13	+2 -13	80	100	
												100	120	
+ 40 0	+ 63 0	+100 0	+160 0	+250 0	+630 0	+18 -7	+12.5 -12.5	+26 -14	+20 -20	+3 -15	+3 -15	120	140	
												140	160	
												160	180	
+ 46 0	+ 72 0	+115 0	+185 0	+290 0	+720 0	+22 -7	+14.5 -14.5	+30 -16	+23 -23	+2 -18	+2 -18	180	200	
												200	225	
												225	250	
+ 52 0	+ 81 0	+130 0	+210 0	+320 0	+810 0	+25 -7	+16 -16	+36 -16	+26 -26	+3 -20	+3 -20	250	280	
												280	315	
+ 57 0	+ 89 0	+140 0	+230 0	+360 0	+890 0	+29 -7	+18 -18	+39 -18	+28.5 -28.5	+3 -22	+3 -22	315	355	
												355	400	
+ 63 0	+ 97 0	+155 0	+250 0	+400 0	+970 0	+33 -7	+20 -20	+43 -20	+31.5 -31.5	+2 -25	+2 -25	400	450	
												450	500	
+ 70 0	+110 0	+175 0	+280 0	+440 0	- 0	- -	+22 -22	- -	+35 -35	- -	- -	500	560	
												560	630	
+ 80 0	+125 0	+200 0	+320 0	+500 0	- 0	- -	+25 -25	- -	+40 -40	- -	- -	630	710	
												710	800	
+ 90 0	+140 0	+230 0	+360 0	+560 0	- 0	- -	+28 -28	- -	+45 -45	- -	- -	800	900	
												900	1 000	
+105 0	+165 0	+260 0	+420 0	+660 0	- 0	- -	+33 -33	- -	+52.5 -52.5	- -	- -	1 000	1 120	
												1 120	1 250	
+125 0	+195 0	+310 0	+500 0	+780 0	- 0	- -	+39 -39	- -	+62.5 -62.5	- -	- -	1 250	1 400	
												1 400	1 600	
+150 0	+230 0	+370 0	+600 0	+920 0	- 0	- -	+46 -46	- -	+75 -75	- -	- -	1 600	1 800	
												1 800	2 000	

Appendix table 7: Basic tolerance

Unit μm

Diameter division mm		IT basic tolerance class									
over	incl.	IT1	IT2	IT3	IT4	IT5	IT6	IT7	IT8	IT9	IT10
—	3	0.8	1.2	2	3	4	6	10	14	25	40
3	6	1	1.5	2.5	4	5	8	12	18	30	48
6	10	1	1.5	2.5	4	6	9	15	22	36	58
10	18	1.2	2	3	5	8	11	18	27	43	70
18	30	1.5	2.5	4	6	9	13	21	33	52	84
30	50	1.5	2.5	4	7	11	16	25	39	62	100
50	80	2	3	5	8	13	19	30	46	74	120
80	120	2.5	4	6	10	15	22	35	54	87	140
120	180	3.5	5	8	12	18	25	40	63	100	160
180	250	4.5	7	10	14	20	29	46	72	115	185
250	315	6	8	12	16	23	32	52	81	130	210
315	400	7	9	13	18	25	36	57	89	140	230
400	500	8	10	15	20	27	40	63	97	155	250
500	630	9	11	16	22	30	44	70	110	175	280
630	800	10	13	18	25	35	50	80	125	200	320
800	1 000	11	15	21	29	40	56	90	140	230	360
1 000	1 250	13	18	24	34	46	66	105	165	260	420
1 250	1 600	15	21	29	40	54	78	125	195	310	500
1 600	2 000	18	25	35	48	65	92	150	230	370	600
2 000	2 500	22	30	41	57	77	110	175	280	440	700
2 500	3 150	26	36	50	69	93	135	210	330	540	860

Appendix table 8: Viscosity conversion table

Kinematic viscosity mm ² /s	Saybolt SUS (second)	Redwood R ⁿ (second)	Engler E (degree)	Kinematic viscosity mm ² /s	Saybolt SUS (second)	Redwood R ⁿ (second)	Engler E (degree)
2.7	35	32.2	1.18	103	475	419	13.5
4.3	40	36.2	1.32	108	500	441	14.2
5.9	45	40.6	1.46	119	550	485	15.6
7.4	50	44.9	1.60	130	600	529	17.0
8.9	55	49.1	1.75	141	650	573	18.5
10.4	60	53.5	1.88	152	700	617	19.9
11.8	65	57.9	2.02	163	750	661	21.3
13.1	70	62.3	2.15	173	800	705	22.7
14.5	75	67.6	2.31	184	850	749	24.2
15.8	80	71.0	2.42	195	900	793	25.6
17.0	85	75.1	2.55	206	950	837	27.0
18.2	90	79.6	2.68	217	1 000	882	28.4
19.4	95	84.2	2.81	260	1 200	1 058	34.1
20.6	100	88.4	2.95	302	1 400	1 234	39.8
23.0	110	97.1	3.21	347	1 600	1 411	45.5
25.0	120	105.9	3.49	390	1 800	1 587	51
27.5	130	114.8	3.77	433	2 000	1 763	57
29.8	140	123.6	4.04	542	2 500	2 204	71
32.1	150	132.4	4.32	650	3 000	2 646	85
34.3	160	141.1	4.59	758	3 500	3 087	99
36.5	170	150.0	4.88	867	4 000	3 526	114
38.8	180	158.8	5.15	974	4 500	3 967	128
41.0	190	167.5	5.44	1 082	5 000	4 408	142
43.2	200	176.4	5.72	1 150	5 500	4 849	156
47.5	220	194.0	6.28	1 300	6 000	5 290	170
51.9	240	212	6.85	1 400	6 500	5 730	185
56.5	260	229	7.38	1 510	7 000	6 171	199
60.5	280	247	7.95	1 630	7 500	6 612	213
64.9	300	265	8.51	1 740	8 000	7 053	227
70.3	325	287	9.24	1 850	8 500	7 494	242
75.8	350	309	9.95	1 960	9 000	7 934	256
81.2	375	331	10.7	2 070	9 500	8 375	270
86.8	400	353	11.4	2 200	10 000	8 816	284
92.0	425	375	12.1				
97.4	450	397	12.8				

Appendix table 9: Kgf to N conversion table

kgf		N	kgf		N	kgf		N
0.1020	1	9.8066	3.4670	34	333.43	6.8321	67	657.04
0.2039	2	19.613	3.5690	35	343.23	6.9341	68	666.85
0.3059	3	29.420	3.6710	36	353.04	7.0361	69	676.66
0.4079	4	39.227	3.7730	37	362.85	7.1380	70	686.46
0.5099	5	49.033	3.8749	38	372.65	7.2400	71	696.27
0.6118	6	58.840	3.9769	39	382.46	7.3420	72	706.08
0.7138	7	68.646	4.0789	40	392.27	7.4440	73	715.88
0.8158	8	78.453	4.1808	41	402.07	7.5459	74	725.69
0.9177	9	88.260	4.2828	42	411.88	7.6479	75	735.50
1.0197	10	98.066	4.3848	43	421.68	7.7499	76	745.30
1.1217	11	107.87	4.4868	44	431.49	7.8518	77	755.11
1.2237	12	117.68	4.5887	45	441.30	7.9538	78	764.92
1.3256	13	127.49	4.6907	46	451.10	8.0558	79	774.72
1.4276	14	137.29	4.7927	47	460.91	8.1578	80	784.53
1.5296	15	147.10	4.8946	48	470.72	8.2597	81	794.34
1.6316	16	156.91	4.9966	49	480.52	8.3617	82	804.14
1.7335	17	166.71	5.0986	50	490.33	8.4637	83	813.95
1.8355	18	176.52	5.2006	51	500.14	8.5656	84	823.76
1.9375	19	186.33	5.3025	52	509.94	8.6676	85	833.56
2.0394	20	196.13	5.4045	53	519.75	8.7696	86	843.37
2.1414	21	205.94	5.5065	54	529.56	8.8716	87	853.18
2.2434	22	215.75	5.6085	55	539.36	8.9735	88	862.98
2.3454	23	225.55	5.7104	56	549.17	9.0755	89	872.79
2.4473	24	235.36	5.8124	57	558.98	9.1775	90	882.60
2.5493	25	245.17	5.9144	58	568.78	9.2794	91	892.40
2.6513	26	254.97	6.0163	59	578.59	9.3814	92	902.21
2.7532	27	264.78	6.1183	60	588.40	9.4834	93	912.02
2.8552	28	274.59	6.2203	61	598.20	9.5854	94	921.82
2.9572	29	284.39	6.3223	62	608.01	9.6873	95	931.63
3.0592	30	294.20	6.4242	63	617.82	9.7893	96	941.44
3.1611	31	304.01	6.5262	64	627.62	9.8913	97	951.24
3.2631	32	313.81	6.6282	65	637.43	9.9932	98	961.05
3.3651	33	323.62	6.7302	66	647.24	10.0952	99	970.86

(How to read the table) If for example you want to convert 10 kgf to N, find "10" in the middle column of the first set of columns on the right. Look in the N column directly to the right of "10," and you will see that 10 kgf equals 98.066 N. Oppositely, to convert 10 N to kgf, look in the kgf column to the right of "10" and you will see that 10 N equals 1.0197 kgf.

1kgf=9.80665N
1N=0.101972kgf

Appendix table 10: Inch-millimetre conversion table

inch		0"	1"	2"	3"	4"	5"	6"	7"	8"	9"
fraction	decimal										
1/64	0.015625	0.397	25.400	50.800	76.200	101.600	127.000	152.400	177.800	203.200	228.600
1/32	0.031250	0.794	25.797	51.197	76.597	101.997	127.397	152.797	178.197	203.597	228.997
3/64	0.046875	1.191	26.194	51.594	76.994	102.394	127.794	153.194	178.594	203.994	229.394
1/16	0.062500	1.588	26.591	51.991	77.391	102.791	128.191	153.591	178.991	204.391	229.791
5/64	0.078125	1.984	26.988	52.388	77.788	103.188	128.588	153.988	179.388	204.788	230.188
3/32	0.093750	2.381	27.384	52.784	78.184	103.584	128.984	154.384	179.784	205.184	230.584
7/64	0.109375	2.778	27.781	53.181	78.581	103.981	129.381	154.781	180.181	205.581	230.981
1/ 8	0.125000	3.175	28.178	53.578	78.978	104.378	129.778	155.178	180.578	205.978	231.378
9/64	0.140625	3.572	28.575	53.975	79.375	104.775	130.175	155.575	180.975	206.375	231.775
5/32	0.156250	3.969	28.972	54.372	79.772	105.172	130.572	155.972	181.372	206.772	232.172
11/64	0.171875	4.366	29.369	54.769	80.169	105.569	130.969	156.369	181.769	207.169	232.569
3/16	0.187500	4.762	29.766	55.166	80.566	105.966	131.366	156.766	182.166	207.566	232.966
13/64	0.203125	5.159	30.162	55.562	80.962	106.362	131.762	157.162	182.562	207.962	233.362
7/32	0.218750	5.556	30.559	55.959	81.359	106.759	132.159	157.559	182.959	208.359	233.759
15/64	0.234375	5.953	30.956	56.356	81.756	107.156	132.556	157.956	183.356	208.756	234.156
1/ 4	0.250000	6.350	31.353	56.753	82.153	107.553	132.953	158.353	183.753	209.153	234.553
17/64	0.265625	6.747	31.750	57.150	82.550	107.950	133.350	158.750	184.150	209.550	234.950
9/32	0.281250	7.144	31.750	57.547	82.947	108.347	133.747	159.147	184.547	209.947	235.347
19/64	0.296875	7.541	32.147	57.944	83.344	108.744	134.144	159.544	184.944	210.344	235.744
5/16	0.312500	7.938	32.544	58.341	83.741	109.141	134.541	159.941	185.341	210.741	236.141
21/64	0.328125	8.334	32.941	58.738	84.138	109.538	134.938	160.338	185.738	211.138	236.538
11/32	0.343750	8.731	33.338	59.134	84.534	109.934	135.334	160.734	186.134	211.534	236.934
23/64	0.359375	9.128	33.734	59.531	84.931	110.331	135.731	161.131	186.531	211.931	237.331
3/ 8	0.375000	9.525	34.131	59.928	85.328	110.728	136.128	161.528	186.928	212.328	237.728
25/64	0.390625	9.922	34.528	60.325	85.725	111.125	136.525	161.925	187.325	212.725	238.125
13/32	0.406250	10.319	34.925	60.722	86.122	111.522	136.922	162.322	187.722	213.122	238.522
27/64	0.421875	10.716	35.322	61.119	86.519	111.919	137.319	162.719	188.119	213.519	238.919
7/16	0.437500	11.112	35.719	61.516	86.916	112.316	137.716	163.116	188.516	213.916	239.316
29/64	0.453125	11.509	36.116	61.912	87.312	112.712	138.112	163.512	188.912	214.312	239.712
15/32	0.468750	11.906	36.512	62.309	87.709	113.109	138.509	163.909	189.309	214.709	240.109
31/64	0.484375	12.303	36.909	62.706	88.106	113.506	138.906	164.306	189.706	215.106	240.506
1/ 2	0.500000	12.700	37.306	63.103	88.503	113.903	139.303	164.703	190.103	215.503	240.903
33/64	0.515625	13.097	37.703	63.500	88.900	114.300	139.700	165.100	190.500	215.900	241.300
17/32	0.531250	13.494	38.100	63.897	89.297	114.697	140.097	165.497	190.897	216.297	241.697
35/64	0.546875	13.891	38.494	64.294	89.694	115.094	140.494	165.894	191.294	216.694	242.094
9/16	0.562500	14.288	38.894	64.691	90.091	115.491	140.891	166.291	191.691	217.091	242.491
37/64	0.578125	14.684	39.291	65.088	90.488	115.888	141.283	166.688	192.088	217.488	242.888
19/32	0.593750	15.081	39.688	65.484	90.884	116.284	141.684	167.084	192.484	217.884	243.284
39/64	0.609375	15.478	40.084	65.881	91.281	116.681	142.081	167.481	192.881	218.281	243.681
5/ 8	0.625000	15.875	40.481	66.278	91.678	117.078	142.478	167.878	193.278	218.678	244.078
41/64	0.640625	16.272	40.878	66.675	92.075	117.475	142.875	168.275	193.675	219.075	244.475
21/32	0.656250	16.669	41.275	67.072	92.472	117.872	143.272	168.672	194.072	219.472	244.872
43/64	0.671875	17.066	41.672	67.469	92.869	118.269	143.669	169.069	194.469	219.869	245.269
11/16	0.687500	17.462	42.069	67.866	93.266	118.666	144.066	169.466	194.866	220.266	245.666
45/64	0.703125	17.859	42.466	68.262	93.662	119.062	144.462	169.862	195.262	220.662	246.062
23/32	0.718750	18.256	42.862	68.659	94.059	119.459	144.859	170.259	195.659	221.056	246.459
47/64	0.734375	18.653	43.259	69.056	94.456	119.856	145.256	170.656	196.056	221.456	246.856
3/ 4	0.750000	19.050	43.656	69.453	94.853	120.253	145.653	171.053	196.453	221.853	247.253
49/64	0.765625	19.447	44.053	69.850	95.250	120.650	146.050	171.450	196.850	222.250	247.650
25/32	0.781250	19.844	44.450	70.247	95.647	121.047	146.447	171.847	197.247	222.647	248.047
51/64	0.796875	20.241	44.847	70.644	96.044	121.444	146.844	172.244	197.644	223.044	248.444
13/16	0.812500	20.638	45.244	71.041	96.441	121.841	147.241	172.641	198.041	223.441	248.841
53/64	0.828125	21.034	45.641	71.438	96.838	122.238	147.638	173.038	198.438	223.838	249.238
27/32	0.843750	21.431	46.038	71.834	97.234	122.634	148.034	173.434	198.834	224.234	249.634
55/64	0.859375	21.828	46.434	72.231	97.631	123.031	148.431	173.831	199.231	224.631	250.031
7/ 8	0.875000	22.225	46.831	72.628	98.028	123.428	148.828	174.228	199.628	225.028	250.428
57/64	0.890625	22.622	47.228	73.025	98.425	123.825	149.225	174.625	200.025	225.425	250.825
29/32	0.906250	23.019	47.625	73.422	98.822	124.222	149.622	175.022	200.422	225.822	251.222
59/64	0.921875	23.416	48.022	73.819	99.219	124.619	150.019	175.419	200.819	226.219	251.619
15/16	0.937500	23.812	48.419	74.216	99.616	125.016	150.416	175.816	201.216	226.616	252.016
61/64	0.953125	24.209	48.816	74.612	100.012	125.412	150.812	176.212	201.612	227.012	252.412
31/32	0.968750	24.606	49.212	75.009	100.409	125.809	151.209	176.609	202.009	227.409	252.809
63/64	0.984375	25.003	49.609	75.406	100.806	126.206	151.606	177.006	202.406	227.806	253.206
			50.403	75.803	101.203	126.603	152.003	177.403	202.803	228.203	253.603

Appendix table 11: Hardness conversion table (reference)

Rockwell hardness C scale 1471.0N {150kgf}	Picker's hardness	Brinell hardness		Rockwell hardness		Shore hardness
		Standard steel balls	Tungsten carbide steel balls	A scale 588.4N {60kgf}	B scale 980.7N {100kgf}	
68	940			85.6		97
67	900			85.0		95
66	865			84.5		92
65	832		739	83.9		91
64	800		722	83.4		88
63	772		705	82.8		87
62	746		688	82.3		85
61	720		670	81.8		83
60	697		654	81.2		81
59	674		634	80.7		80
58	653		615	80.1		78
57	633		595	79.6		76
56	613		577	79.0		75
55	595	—	560	78.5		74
54	577	—	543	78.0		72
53	560	—	525	77.4		71
52	544	500	512	76.8		69
51	528	487	496	76.3		68
50	513	475	481	75.9		67
49	498	464	469	75.2		66
48	484	451	455	74.7		64
47	471	442	443	74.1		63
46	458	432	432	73.6		62
45	446	421	421	73.1		60
44	434	409	409	72.5		58
43	423	400	400	72.0		57
42	412	390	390	71.5		56
41	402	381	381	70.9		55
40	392	371	371	70.4	—	54
39	382	362	362	69.9	—	52
38	372	353	353	69.4	—	51
37	363	344	344	68.9	—	50
36	354	336	336	68.4	(109.0)	49
35	345	327	327	67.9	(108.5)	48
34	336	319	319	67.4	(108.0)	47
33	327	311	311	66.8	(107.5)	46
32	318	301	301	66.3	(107.0)	44
31	310	294	294	65.8	(106.0)	43
30	302	286	286	65.3	(105.5)	42
29	294	279	279	64.7	(104.5)	41
28	286	271	271	64.3	(104.0)	41
27	279	264	264	63.8	(103.0)	40
26	272	258	258	63.3	(102.5)	38
25	266	253	253	62.8	(101.5)	38
24	260	247	247	62.4	(101.0)	37
23	254	243	243	62.0	100.0	36
22	248	237	237	61.5	99.0	35
21	243	231	231	61.0	98.5	35
20	238	226	226	60.5	97.8	34
(18)	230	219	219	—	96.7	33
(16)	222	212	212	—	95.5	32
(14)	213	203	203	—	93.9	31
(12)	204	194	194	—	92.3	29
(10)	196	187	187		90.7	28
(8)	188	179	179		89.5	27
(6)	180	171	171		87.1	26
(4)	173	165	165		85.5	25
(2)	166	158	158		83.5	24
(0)	160	152	152		81.7	24

Note 1: Quoted from hardness conversion table (SAE J417)

Appendix table 12: Greek alphabet list

Upright	Italic		Reading
	Upper case	Lower case	
A	<i>A</i>	<i>α</i>	Alpha
B	<i>B</i>	<i>β</i>	Beta
Γ	<i>Γ</i>	<i>γ</i>	Gamma
Δ	<i>Δ</i>	<i>δ</i>	Delta
E	<i>E</i>	<i>ε</i>	Epsilon
Z	<i>Z</i>	<i>ζ</i>	Zeta
H	<i>H</i>	<i>η</i>	Eta
Θ	<i>Θ</i>	<i>θ</i>	Theta
I	<i>I</i>	<i>ι</i>	Iota
K	<i>K</i>	<i>κ</i>	Kappa
Λ	<i>Λ</i>	<i>λ</i>	Lambda
M	<i>M</i>	<i>μ</i>	Mu
N	<i>N</i>	<i>ν</i>	Nu
Ξ	<i>Ξ</i>	<i>ξ</i>	Xi
O	<i>O</i>	<i>ο</i>	Omicron
Π	<i>Π</i>	<i>π</i>	Pi
P	<i>P</i>	<i>ρ</i>	Rho
Σ	<i>Σ</i>	<i>σ</i>	Sigma
T	<i>T</i>	<i>τ</i>	Tau
Υ	<i>Υ</i>	<i>υ</i>	Upsilon
Φ	<i>Φ</i>	<i>φ</i>	Phi
X	<i>X</i>	<i>χ</i>	Chi
Ψ	<i>Ψ</i>	<i>ψ</i>	Psi
Ω	<i>Ω</i>	<i>ω</i>	Omega